

> Power Team®

TOUGH PRODUCTS FOR TOUGH APPLICATIONS



Over 90 years experience in supplying Professional Grade High Pressure Hydraulic Pumps, Cylinders, Jacks, Pullers & Tools. Combining our tough products with application expertise and training makes your life safer, easier and more efficient.

A Heritage of Innovation

Since 1924, we've been instrumental in the development of innovative high force hydraulic power products, systems and tools. Many of our products are known as the industry standard for rugged construction, reliability, and long service life. Today, we provide a full range of professional grade products and services around the globe.

Power Team Quality

Power Team Products are built tough with strict ISO 9001 manufacturing processes and are covered by a Lifetime PowerThon Warranty*.

Global Distribution and Service

Wherever your job is in the world, the Power Team network of distributors and service centers assures local product, parts and service availability.

- TABLE OF CONTENTS -



CYLINDERS
5-42



PUMPS
43-110



**HYDRAULIC
ACCESSORIES**
111-144

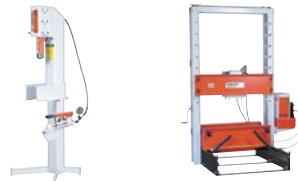

**SHOP
EQUIPMENT**
145-162



JACKS
163-184



**HYDRAULIC
& MECHANICAL
TOOLS**
185-222



PULLERS
223-264



RESOURCES
265-281





NUMERIC INDEX

BB1600,1601.....	214	PH53C, PH53CR.....	249	SPM556, SPM5513.....	153	209593.....	109, 133	350090.....	179	9015B, 9022B, 9033B.....	169
BC212 - BC212EUR.....	74	PH63C, PH83C, PH113C.....	247	SPM10010.....	154	21242, 21247-21258.....	262	350094-350100.....	15-16	9040 - 9089.....	139
BP12INT.....	74	PH172, PH173, PH173R.....	250	SPX256C.....	149	212377.....	263	350144, 350145.....	15, 34, 213	9049.....	110
C51C-C10010C.....	9, 11-12, 279	PH303, PH303R.....	250	SS2.....	235	21332.....	160	350184.....	15	9050A.....	169
C55CBT - C2514CBT.....	13, 279	PH303C.....	247	TBP1622.....	159	213895, 213896.....	126	350199.....	110	9042DG, 9042DG1500.....	141-142
CB30, CB50, CB100.....	20	PH503.....	250	TPP1 - TPP200.....	159	215315.....	238	350207-350209.....	179	9105A.....	167
CB555-CBS200.....	175	PH553C - PH553CL13.....	259-260	TPS6.....	159	216209.....	133	350320-350332.....	19	9110B, 9112A, 9120A.....	169
CC5-CC25.....	213	PH82K.....	247, 271	TWH15 - TWH50.....	195	21669 - 21873.....	23	350376.....	15	9130A.....	168
DFTAS000001.....		PHP8H - PHP8R-1.....	258	TWHC Series.....	187-190	22041 - 22044.....	219	350431.....	110, 125	9190.....	143
DFTAS000002.....	188, 189, 191	PMA, PUA.....	67-70	TWLC Series.....	195-199	22185.....	235	350549.....	211, 260	9205A - 9220A.....	167
DG100, DG100B.....	140	PMA55 - PMA355S.....		TWSD Series.....	191-194	22274, 22275.....	23	350550.....	211	927.....	231-232, 237
FC2200 - FC4400.....	161	PME55 - PME355S.....	176	TWSL Series.....	201-202	23934.....	262	350593-350594.....	259	938, 939.....	231-232
FK59.....	49	PPH17 - PPH50R.....	251-252	X1A1.....	204	24016.....	16	350637.....	52, 259, 260	9500, 9501.....	109, 120
FK159B.....	51	PQ603 - PQ604S.....	91-92	X1E1, X1E2.....	203	24196, 24197.....	23	350722.....	52, 180	9502.....	109, 115, 119
FLS15, FLS15-ST.....	209	PQ1203 - PQ1204S.....	93-94	0100 - 0600.....	220	24813, 24814.....	24	350723-350724.....	15	9504.....	109, 115, 118
HFS3A - HFS6A.....	211	PR102 - PR104.....	73-74	10012, 10020.....	263	24832 - 24833.....	233	350822, 350823.....	211	9506, 9507.....	109, 120
HB443, HB444.....	105	PR2100J-PR3100S.....	261-262	1020 - 1027.....		24835 - 34836.....	235	350895-350898.....	16	9508, 9509.....	128
HNS150 - HNS225.....	208	PT102 - PT116.....		1035 - 1050.....	229-230	25017.....	110, 133	351075, 351106.....	14	9510.....	134
HP35-HP35SP.....	215-216	PT202 - PT216.....	243-244, 246	1057 - 1080.....	249	250175.....	125	351324, 351325, 351334.....	34	9511.....	109, 120
HS2000 - HS3000.....	212	PT11054, PT11054L.....		1023, 1027.....	237	250341 - 250343.....	179	351574 - 351576.....	15-16	9512, 9513.....	109, 123
HST11, HST11S.....	247-248	PT11354L, PT11654L.....	244	1057 - 1060.....	249	250353.....	179	351830.....	262	9514.....	128
HT50A - HT200.....	217	PTPHB106-PTPHB116.....		1060.....	250	250459.....	216	351985.....	208	9515.....	134
HTS50.....	222	PTPHB206-PTPHB216.....	244	1062.....	252	250682.....	179	36161.....	12	9516.....	123
IM10E, IM10H, IM10L.....	180	PTPHC106-PTPHC116.....		1064, 1066.....	250	251002.....	259, 260	36469.....	160	9517.....	118
IJ13T - IJ7520T.....	177-178	PTPHC206-PTPHC216.....		1070.....	250	251410 - 251411.....	138	36578.....	235, 238	9519.....	123
IPS10B, IPS10HB.....	238	PTPHD106-PTPHD116.....		1074.....	252	251468.....	259	37045.....	138, 218	9520.....	109, 119
IPS10M, IPS17M.....	241	PTPHD206-PTPHD216.....	245	1076.....	252	251646, 251647.....	242	37368.....	159-160	9521.....	134
IPS17, IPS17B, IPS17H.....	253	PTPH100T-PTPH200T.....	246	1080.....	250	251660.....	133	38597.....	159, 160, 213	9522, 9523.....	123
IPS30H.....	254	PTP4-PTP16.....	246	10461.....	110, 133	252000.....	216	38855, 38904.....	21-22	9524.....	127
IPS3017, IPS3017B.....	255	PTPT-2550, PTPT3050.....	245	10494.....	92, 94, 110, 125	252215.....	21	38908, 38909.....	16	9525, 9526.....	128
IPSS0H.....	254	R552C - R56510C.....	35, 279	R552C - R56510C.....	263	25228.....	213	38953.....	159, 160, 213	9531.....	134
IPSS017, IPS017B.....	256	R1002D - R56510D.....	36, 279	R1002D - R56510D.....	36, 279	252364 - 252365.....	138	38954.....	160	9552.....	122
IPSS317.....	257	R552L - R56510L.....	40, 279	R552L - R56510L.....	40, 279	252511, 252512.....	90, 125	40063OR9.....	108, 110	9553.....	123
J24T, J55T, J106T.....	171	RA202 - RA1006.....	17, 279	RA202 - RA1006.....	17, 279	252542 - 253391.....	184	40137OR9.....	110	9554.....	127
J58T, J109T, J259T.....	172	RA556L, RA1006L.....	39, 279	RA556L, RA1006L.....	39, 279	253155-253395.....	262	41331.....	235	9555, 9556, 9559.....	128
JAM10033 - JAM15033, JAR10033.....		RB8013S - RB20013S.....	158	RB8013S - RB20013S.....	158	25388 - 25750.....	15-16	420059 - 420064.....	15-16	9560.....	71, 74
JEM5526 - JEM15026.....	176	RC0552P-RC6202P.....	41	RC0552P-RC6202P.....	41	25931.....	24	420496BK2, 420498BK2.....	17	9561-9563.....	71, 74
JM25 - JM420.....	176	RC12V.....	74	RC12V.....	74	26068 - 26079.....	219	420655OR9.....	11	9569, 9570, 9572.....	122
K82, K83.....	248	RC2GAL, RC5.....	126	RC2GAL, RC5.....	126	26666.....	219	420778.....	140	9575.....	131
LR2000 - LR6000.....	162	RC7402C - RC122010C.....	37	RC7402C - RC122010C.....	37	27198.....	24	420845-420846.....	262	9579.....	122
MBS - MB16.....	242	RC7402D - RC122010D.....	38	RC7402D - RC122010D.....	38	27241.....	235, 236	420866-420871.....	35, 40	9580-9581.....	131
MCS-PE554-8 - MCS-PQ1204.....	97-98	RC7402L - RC122010L.....	42	RC7402L - RC122010L.....	42	27287.....	219	421056, 421057.....	14	9582, 9584.....	109, 115, 117
P12, P19, P19L, P23, P55.....	49	RD106 - RD50013.....	33-34, 279	RD106 - RD50013.....	33-34, 279	27315.....	235, 238	421312OR9.....	22	9589, 9590.....	123
P59L, P59L-1500.....	50	RDG552 - RDG60014.....	29-32, 279	RDG552 - RDG60014.....	29-32, 279	27487-27555.....	263	43562, 43563.....	159, 160	9592.....	122
PA157 - PA60D.....	51	RG552 - RGG60014.....	25-28, 279	RG552 - RGG60014.....	25-28, 279	27737.....	219	44148, 44195.....	235, 237	9593.....	127
PA172 - PA174.....	63-64	RH102-RH2008.....	21-22, 279	RH102-RH2008.....	21-22, 279	27793 - 27797.....	263	44457, 44458.....	160	9594.....	109, 122
PA6 - PA6M-2.....	53-54	RH306D.....	22, 279	RH306D.....	22, 279	27876, 27877.....	110	45589.....	20	9595.....	127
PA6D - PA6DM-2.....	55-56	RHA20-RHA100.....	24	RHA20-RHA100.....	24	28228-28230.....	24	46070.....	159, 160	9596, 9597.....	129
PA7.....	239	RHA306.....	21	RHA306.....	21	28229.....	213	47997.....	249	9599, 9605.....	109, 121
PA9, PA9H.....	57-58	RHA604D.....	22, 279	RHA604D.....	22, 279	28612 - 28644.....	21-22	518.....	239	9608.....	129
PA50, PA50D, PA50R.....	61-62	RH121T.....	9, 21, 280	RH121T.....	9, 21, 280	28984, 28985.....	219	522.....	237, 239	9609.....	109, 121
PA55.....	109	RJ Series.....	173-174	RJ Series.....	173-174	29595.....	24	58943 - 58945.....	175	9610.....	109, 115, 117
PA60, PA64.....	59-60	RLS50 - RLS1500S.....	18, 279	RLS50 - RLS1500S.....	18, 279	3-3944 - 3-3959.....	137	60846.....	149	9610A.....	115, 117
PA462 - PA554.....	65-66	RP20 - RP104.....	126	RP20 - RP104.....	126	3000975, 3000989.....	72	61165.....	110	9615.....	109, 123
PA90.....	109	RP22, RP50, RP100, RP101.....	110	RP22, RP50, RP100, RP101.....	110	300472 - 300699.....	125	61799OR9.....	110	9616.....	132
PB102-1 - PB104-0.....	71-72	RP25, RP55.....	14, 279	RP25, RP55.....	14, 279	302482, 302483.....	24	679, 680.....	234	9617.....	144
PB1230C - PB51156C.....	242	RPS55 - RPS556A.....	52	RPS55 - RPS556A.....	52	303785.....	294	6981.....	235	9620-9621.....	134
PC200, PC200RC.....	126	RSS101 - RSS2503.....	19-20	RSS101 - RSS2503.....	19-20	30416-30417.....	262	7053K.....	220	9623.....	131
PD313 - PD812.....	216	RT172 - RT1004.....	23-24, 279	RT172 - RT1004.....	23-24, 279	304718.....	109, 133	7103.....	222	9625.....	134
PE-NUT.....	99	RV21278 - RV21278-90.....	130	RV21278 - RV21278-90.....	130	30512, 30519-30522.....		7123K, 7125K.....	220	9626, 9627.....	109, 144
PE102 - PE104.....	73-74	RWP55, RWP55-4.....	207	RWP55, RWP55-4.....	207	30585-30586.....	262	7136.....	236	9628.....	109, 115, 124
PE120.....	109	SB15.....	210	SB15.....	210	307159.....	179	714.....	220	9631.....	130
PE120M.....	107-108	SF50.....	153, 157	SF50.....	153, 157	307281.....	218	7162 - 7168.....	221	9632.....	109, 115, 124
PE172 - PE174M.....	75-76	SF150.....	154, 155, 157	SF150.....	154, 155, 157	308022.....	208	7180.....	263	9633.....	130
PE182 - PE184C.....	77-78	SJ2010 - SJ2010P.....		SJ2010 - SJ2010P.....		308435OR9.....	182, 253	7208.....	237	9634, 9635.....	144
PE213 - PE214S.....	79-80	SJ3010 - SJ3010P.....	183-184	SJ3010 - SJ3010P.....	183-184	308436OR9.....	255	7300, 7301.....	220	9636-9640.....	132
PE302 - PE304R-2.....	83-84	SK10T, SK10TE.....	181	SK10T, SK10TE.....	181	308438OR9.....	254	7307 - 7309.....	221	9637-9640, 9645, 9646.....	110
PE30TWP.....	205	SK25T, SK25TE.....	182	SK25T, SK25TE.....	182	308439OR9.....	256	7312.....	222	9641.....	110, 134
PE462 - PE464S.....	85-86	SP1010A.....	150	SP1010A.....	150	308440OR9.....	257	7313.....	220	9642.....	144
PE55.....	109	SPA10 - SPA200.....	160	SPA10 - SPA200.....	160	308840.....	208	7350.....	263	9643.....	110, 134
PE550 - PE554W.....	87-88	SPA2514.....	152	SPA2514.....	152	309652, 309653.....	109, 133	7392.....	239	9644.....	144
PE552S.....	87-88, 260	SPA256.....	151	SPA256.....	151	309874.....	213, 249	7393.....	237, 239	9645-9647.....	132
PE55TWP - PE55TWP4.....	206	SPA556.....	153	SPA556.....	153	309875.....	249	7395.....	222	9648.....	144
PE604T - PE604PT.....	89-90	SPE1010, SPE1010D.....	150	SPE1010, SPE1010D.....	150	31772, 31776.....	16	7400, 7401.....	221	9649-9690.....	143
PE4004, PE4004S.....	95-96	SPE2514 - SPE2514DS.....	152	SPE2514 - SPE2514DS.....	152	32054.....	235	7402.....	222	9691.....	144
PE84.....	75-76	SPE256.....	151	SPE256.....	151	32118.....	24	7406K.....	220	9692 - 9705.....	143
PED253 - PED254S.....	81-82	SPE556 - SPE5513DS.....	153	SPE556 - SPE5513DS.....	153	32325.....	180	7420, 7421.....	221	9706, 9707.....	129
PG120HM.....	103	SPE10010 - SPE10013DS.....		SPE10010 - SPE10013DS.....		32698 - 33439.....	24	8000 - 8029.....	240	9733-9736, 9754-9762.....	135
PG1203-CP.....	100	SPE10010R.....	154	SPE10010R.....	154	34136.....	24	8035 - 8044.....	239	9776-9779.....	135
PG1200M-4 - PG1204S.....	103-104	SPE15013DS.....	125	SPE15013DS.....	125	34251.....	22	8056 - 8056.....	240	9750-9751, 9764-9772.....	132
PG303 - PG554.....	101-102	SPE20013DS.....	156	SPE20013DS.....	156	34331.....	235	8057-8073, 8075-8076.....	240	9780-9783.....	136
PG4204, PG404S.....	103-104	SPH1010, SPM1010.....	150	SPH1010, SPM1010.....	150	34510, 34511.....	160, 213	8110-9117, 8120-8126.....	239	9773-9775.....	137
PG55.....	109	SPM2514.....	152	SPM2514.....	152	34698.....	235	885.....			



A

Adapters

- Fittings, Hydraulic Testers 219
- Step Plate 240
- Threaded (Puller) 239-240

Air Filter/Regulator/Lubricator 134

Air/Hydraulic Pumps 43-70

Aluminum Cylinders 17, 21-22

"Assemble to Order" Pumps 107-110

Attachments, Puller 233-234

Axle Journal Roller Bearing Service Equipment 261-262

B

Battery Pumps 71-72

Bead Breaker 214

Bearing Cup Installer 263

Bearing Cup Remover 236

Bearing Pulling Attachments 233-234

Bench Presses 150

Bi-Directional™ Pullers 237-238

Blankets, Protective 242

Blind Hole Puller Set 235

Bottle Jacks 168-170

Bushing and Bearing Drivers 263

C

C-Clamps 213

C-Frame Press 149

Carts

- Hydraulic Lift Cart 245
- Storage Transport Cart 245
- Universal Pump Cart 126

Casters 92, 94, 110, 125, 242

Center-Hole

- Accessories 24
- Cylinders 21-24
- Twin Cylinders 33-34

Chain Wrenches 221

Chaser, Thread 222

Check Valves 131

Construction Cylinders 25-32

Counter-Balance Valve 129

Couplers

- Hydraulic 138, 143
- Testers 219

Crane Accessories 162

Cranes, Mobile 161

Cribbing Block Sets 20, 174-175

Cylinder-Pump-Hose Sets, Hydraulic 52

Cylinders, Hydraulic 11-42

D

Digital Pressure Gauge 140-142

Driver Tools, "Custom-Made" 263

Double-Acting Cylinders 20, 22-24, 29-34, 36, 38

E

Electric/Hydraulic Pumps 73-99

"Enforcer 55" Hydraulic Puller 259

"Enforcer 100" Hydraulic Puller 260

F

Female Straight Flange Adapter 219

Female Threaded Adapters, Pullers 239

Filter/Regulator/Lubricator, Air 134

Fixtures, Straightening 153-158

Flanged Head Adapter Unions 219

Flange Type Puller 239

Floor Cranes, Mobile 161

Flow Characteristics, Valves 113-114

Fluid Level & Temperature Gauge 125

Flush Face Couplers 138

FLS Flange Spreaders 209-210

Foot Control Guard 125

Foot Pump Conversion Kit 49, 51

Forcing Presses 145-158

Four-in-One Puller Set 239

G

Gas Pumps 100-104

Gauges

- Analog 139
- Digital 140-142

General Purpose Cylinders

- C Series 11-12
- Double-Acting 29-32

- Single-Acting 25-28
- Gear and Pulley Pullers 239
- Gland Nut Wrench, Adjustable 221

H

H-Frame Press 150-158

Hand Pumps 49-52

Hand Tools 221

Head Inserts, Cylinder 21-23

High Cycle Torque Wrench 187-190

High Pressure

- Air Operated Pump 67-70

Horseshoe Lock Ring Plier 220

Hoses, Air (Inflatable Jacks) 179

Hoses, Hydraulic

- Non-Conductive Hoses 137
- Polyurethane 136
- Torque Wrench Hoses 137
- Wire-Braid Rubber Hoses 135

Hydraulic Accessories 111-144

Hydraulic Battery Pump 71-72

Hydraulic Couplers 138, 143

Hydraulic Cranes 161

Hydraulic Cylinders 11-42

Hydraulic Flange Spreader 209-210

Hydraulic Fittings 143, 219

Hydraulic Gauges 139-142

Hydraulic Hose 135-137

Hydraulic Jacks 163-184

Hydraulic Manual Pumps 49-52

Hydraulic Nut Splitter 208

Hydraulic Oil 132

Hydraulic Presses, Shop 145-162

Hydraulic Puller Sets 243-246

Hydraulic Pumps 43-110

Hydraulic Punches 215-216

Hydraulic Spreaders 209-212

Hydraulic Testers & Accessories 217-218

Hydraulic Tools 185-222

Hydraulic Valves

- Pump-Mounted 115, 117-124
- In-Line 116, 129-131
- Remote-Mounted 116, 127-128

I

Industrial Maintenance Sets 180

Industrial Maintenance

- Puller Sets 241, 253-257

In-Line Valves 129-131

Inflatable Jacks 177-178

Inflatable Jacks, Accessories 179

Intensifier, Hydraulic 105

Internal Pulling Attachments 233

J

Jack Modules 176

Jacks, Bottle 168-170

Jacks, High-Tonnage 175-176

Jacks, Hydraulic 163-182

Jacks, Hydraulic Toe 171-172

Jacks, Inflatable 177-179

Jacks, Stressing 183-184

Jimmy Bars 221

L

Lifting Handles 17, 21-22

Lightweight Hand-pump 49-52

Load-Lowering Valve 129

Load Rotors® / Load-Positioning Slings 162

Low Profile Cylinders 18

Low Clearance Torque Wrench 195-199

M

Magnetic Pick-Up Tool 222

Magnetic Strip 125

Maintenance Sets 180

Male-Female Threaded Adapters, Pullers 240

Manifolds, Remote & Pump-Mounted 144

Manual Pumps 49-52

Manual Puller Sets 241

Mechanical Posi-Lock® Pullers 243-244

Mechanical Tools 185-222

Metering Valve 130

Metric Adapters 239

Metric Conversion Charts 275-276

Mini Jack 167

Motion Control System 97-98

Motor Controls 133

Mounting Accessories, Cylinder 15-16

N

Nut Splitters 208

Nut Wrench 221

O

Oil Cooler Kits 125

Oil, Hydraulic 132

O-Ring Seal Pick 222

P

Pancake Cylinders 41

Pegboard Display 246

Pilot-Operated

- Air Control Valves 134
- Auto 117
- Check Valve 131
- Solenoid 123

Pipe Sealant, Heavy-Duty 222

Pipe Flange Spreaders 211

Pliers, Retaining Ring 220

Positioning Slings 162

Post-Tensioning Valves 124

Press Accessories 159-160

Presses, Hydraulic Roll-Bed® 157-158

Presses, Hydraulic Shop 145-162

Pressure Switches 134

Pressure Reducing Valve 179

Pressure Regulator Valve, "In-Line" 130

Protective Blankets 242

Pry Bars 221

Puller Adapters 239-240

Puller Attachments 233-234

Puller, Blind Hole 235

Puller Cart 245

Pullers 223-264

Pullers, Bearing 229-263

Pullers, Bearing Cup Remover 236

Pullers, Gear 229-263

Pullers, Hydraulic Bundles 243-246

Pullers, Internal 233-238

Pullers, Jaw-Type 230, 241-242, 253-257

Pullers, Posi-Lock® 243-246

Pullers, Pulley 234

Pullers, Sets 237-238, 241

Pullers, Slide Hammer 235-236

Pullers, Universal

- "Enforcer 55" Hydraulic 259
- "Enforcer 100" Hydraulic 260

Pulley Pullers 234

Pull Cylinder 14

Pump Cart 126

Pump Accessories, Hydraulic 133-134

Pump-Cylinder-Hose Sets, Hydraulic 52

Pump-Mounted Valves 134

Pump Reservoirs 110, 126

Pumps, Hydraulic 43-110

Pumps, Hydraulic

- Accessories 133
- Air 53-70
- Battery 71-72
- Electric 73-99
- Gas 100-104
- Hand 49-52
- Torque Wrench 203-207

Punches, Hydraulic 215-216

Push-Pullers

- Hydraulic 258
- Mechanical 252

Q

Quality Standards, Industry 267

Quarter Horse Pumps 73-74

Quick-Connect Couplers 138

"Quiet" Pumps 91-94

R

Rail Jacks Accessories 174-176

Railroad Axle Journal Bearing Service Equipment 261-262

Ratcheting Chain Wrenches 221

Relief Valve, "In-Line" 130

Remote Controls 133

Remote-Mounted Valves 127-128

Reservoir 110, 126

Reservoir Breather Kit 125

Resources 265-280

Retaining Ring Pliers 220

Rethreading Tools 222

Roll-Bed® Presses 157-158

Roll Cage Pump 126

Roller Bearing Puller / Installer 261-262

Rubber Tire Removing/Installing Set 159

S

Safety Insights 269-270

Seal Kits, Cylinder 279-280

Security Chests 242

Sequence Valve 129

Service Tools 222

Shaft Protector Set 240

Shop Press Accessories 159-160

Shop Presses 145-158

Shorty Cylinders 19-20

Shut-off Valves 131

Single-Acting Cylinders

- 11-14, 17-21, 23-28, 35, 37, 39-42

Slide Hammer Pullers 235-236

SlimLine Torque Wrench 201-202

Solenoid-Operated Valves 122-123

Spanner Wrenches 221

Split Flange Kit 219

Spreaders, Hydraulic 209-212

Square Drive Torque Wrench 191-194

Standards, Quality 267

Startup Kits (SK) 181-182

Step Plate Adapter Sets 240

Storage Boxes

- Maintenance Sets 180
- Metal 182, 242
- Puller Sets 237-238
- Pumps & Cylinders 52
- Wooden 182, 253-257

Storage Transport Cart 245

Straightening Fixtures 153-155, 157

Straightening Tool 248

Stressing Jacks and Pumps 183-184

"Strong Box" Puller Sets 238

Subplates, Pump 134

Switches, Hand and Foot 110, 133

T

Testers

- Accessories 219
- Hydraulic System 218

Temperature & Fluid Level Gauge 125

Thread Chaser 222

Threaded Adapters, Puller 239-240

Tire Pressing Set 159

Tire Removing Tool 214

Toe Jacks, Hydraulic 171-172

Tools, Hydraulic 185-222

Torque Wrench

- Extended Reaction Arm 189, 193
- Handles 189, 193
- Hoses 137
- Links 197-198
- Long Reaction Arm 190, 194
- Pumps 203-207
- Reaction Bar 199
- Reaction Pad 190, 194, 199
- Reducers 196
- Sockets 192

Torque Wrenches

- High-Cycle 187-190
- Low Clearance 195-199
- SlimLine 201-202
- Square Drive 191-194

V

V-Belt Pulley Pulling Attachments 234

Valves, Hydraulic

- Pump-Mounted 109, 117-124
- Remote-Mounted 127-128
- In-Line 129-131

Viton™ Seal Kits 125, 279-280

W

Warranty 268

Wheels (Casters) 92, 94, 110, 125, 242

Wrenches, Industrial 221

Wrenches, Ratcheting Chain 221

Wrenches, Spanner 221

Wrenches, Torque 187-202

CYLINDERS

FROM
2
TO
1220
TONS!

SUPERIOR FEATURES OF POWER TEAM HYDRAULIC CYLINDERS:

We build our own cylinders in our ISO 9001 registered manufacturing facilities. All Power Team cylinders are date coded and stamped with a maximum pressure rating and capacity. Each cylinder we make complies with the demanding ASME B30.1 standard and are assembled/tested by certified assemblers and pressure tested to 125% of capacity before leaving our factories. Some other key features included:

- Cylinder bores are roller burnished to harden and smooth the surface, improving seal life by 30%.
- Base mounting holes withstand full cylinder capacity.
- Typical cylinder burst pressure range is from 25,000 to 35,000 psi, well-beyond extreme usage.
- Cylinders with gland nuts may be “dead-ended” at 10,000 psi.
- Eddy current and mag-particle inspections detect flaws in the steel.
- Material is removed from surface to ensure that any flaws are eliminated.



Page Description	Cylinder Movement	Type of Return	Tonnage Range	Page(s)
Introduction	-	-	-	5-10
C	Single-Acting	Spring	5-100	11-12
CBT	Single-Acting	Spring	5-25	13
RP	Single-Acting	Spring	2-5	14
C Accessories	-	-	-	5-16
RA	Single-Acting	Spring	20-100	17
RLS	Single-Acting	Spring	5-150	18
RSS	Single-Acting Double-Acting	Spring	10-250	19-20
RH	Single-Acting Double-Acting	Spring Hydraulic	100-100 30-200	21-22
RT	Single-Acting	Spring	17.5-100	23-24
RGG	Single-Acting	Load	55-600	25-28
RDG	Double-Acting	Hydraulic	55-600	29-32
RD	Double-Acting	Hydraulic	10-500	33-34
R	Single-Acting Double-Acting	Spring Hydraulic	55-565 100-565	35-36
RC_C RC_D	Single-Acting Double-Acting	Load Hydraulic	740-1220 740-1220	37-38
RA_L R_L	Single-Acting, Locking	Load	55-100 55-565	39-40
RC_P	Single-Acting, Locking	Load	55-620	41
RC_L Series	Single-Acting, Locking	Load	740-1220	42



SELECTING THE RIGHT CYLINDER:

Step 1: Select the hydraulic cylinder that best suits the application.

Step 2: Select a hydraulic pump with adequate oil output and reservoir capacity to power cylinder.

Step 3: Select pump and valve option that is best suited to the cylinder and application.

CYLINDER SIZING CONSIDERATIONS:

1. What push or pull tonnage is required per cylinder in your application? Power Team recommends using 80% of the rated capacity and stroke to maximize product performance and safety.
2. What is the push or pull stroke length required?
3. Does the cylinder need to push, pull or both? (Single-acting cylinders extend the piston under hydraulic pressure. Double-acting cylinders extend and retract the piston under pressure.)
4. Does the application require multiple cylinders?
5. Is the application stationary, or must the components be light in weight for easy portability?
6. Do you need to extend a rod or cable through the center of the cylinder for the application, as in a tensioning operation?
7. Does the application require that the cylinder fit within limited-clearance work areas?
8. Does the application require that the cylinder be "dead-ended" at the end of its work stroke?
9. Will the cylinder need to withstand off-center loads? If yes, consider using swivel load caps.
10. Does the application require that the lifted load be supported for extended periods of time? Locking collars are ideal for such jobs, as are cribbing blocks.
11. Is corrosion resistance required? Our unique "Power-Tech" surface treatment is standard on many Power Team cylinders, and optional on many of our cylinders which feature steel construction.
12. Will the application involve high cycles (over 2,500 in the cylinder's lifetime)? Our "RD," "RH," "RP" and "C" series cylinders are ideal choices. Please refer to pages 12-13 for the capabilities of each cylinder.

WHAT TYPE OF CYLINDER DO YOU NEED?

1. To determine a cylinder's force capacity:

Force pounds

Cylinder Effective Area (sq. in.)

X

PSI from Pump

2. To determine oil capacity of a cylinder:

Oil Capacity (cu. in.)

Cylinder Effective Area (sq. in.)

X

Cylinder Stroke (in.)

3. To determine reservoir capacity needed for a multiple cylinder system:

Usable Oil

Oil Cap. of Cyl. (cu. in.)

X

Number of Cyl. in System

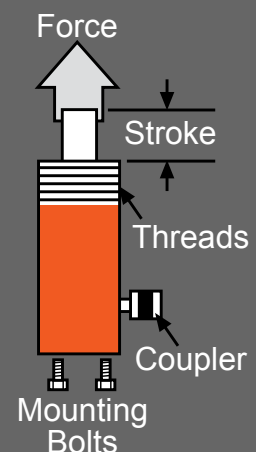



The following guidelines are for general lifting and construction applications. Hydraulic tools, pullers and presses may fall outside these recommendations. Always check to see that the pump's "usable reservoir capacity" exceeds the cylinder(s) oil capacity.

Generally Recommended
Marginal Check Requirements
Not Requirements for most applications

	Pressure Stage	CYLINDER CAPACITY (Tons)														
		5	10	15	20	25	30	55	75	100	150	200	300	400	500	
Hand Pumps *	P12 ‡	Single	14	32	44	65	72	93								
	P55 ‡	Single	6	14	19	28	31	40	71							
	P19(L)	Low	4	8	10	15	17	21								
		High	13	30	42	59	68	86								
	P59F	Low	1.8	4.1	5.7	8	9	12	20	29						
		High	8	17	24	34	48	50	85	122						
	P59(L) ‡	Low	1.5	3.2	4.7	7	7.7	9.7	16.7	23.9						
	P157(D) ‡	High	6	14	19	28	31	40	71	101						
	P159(D) ‡	Low	0.5	1	1.3	1.9	2.2	2.8	5	7	9	13	18			
	P300(D) ‡	High	7	15	21	30	34	43	77	110	143	200	250			
P460(D) ‡	Low	0.1	0.3	0.6	0.6	0.7	0.9	1.5	2.2	2.8	4.2	5.6	8.4	11.2		
	High	3.3	7.7	9	14	17.5	22	37	55	71	105	143	213	284		
Electric/ Hydraulic Pumps †	PB10 / PE10	Low	0.5	1.2	1.6	2.2	2.6	3.2	5.5							
		High	6	13.4	18.9	27	31	39	66.2							
	PE17 ‡	Low	0.2	0.5	0.7	0.9	1.1	1.4	2.3	3.3	4.3	6.5	8.7			
		High	3.5	7.9	10.9	16	18	23	39	56.3	73	109	146			
	PE18	Low	0.4	0.8	1.2	1.6	1.8	2.3	3.9	5.7	7.3	10.8	14.6	21.9	29.2	
		High	3.3	7.5	10.3	15	17	21	37	53	69	102	136	207	276	
	PE21 ‡	Low	0.2	0.5	0.7	1.0	1.1	1.4	2.5	3.6	4.6	6.8	9.2	13.8	18.4	
		High	2.8	6.4	9	13	15	19	32	45.5	59	88	118	177	236	
	PED25	Low	0.2	0.4	0.6	0.9	1.0	1.3	2.2	3.2	4.1	6.1	8.3	12.0	15.7	19.9
		High	2.4	5.4	7.5	10.6	12.4	15.6	26.5	38.2	49.5	73.3	99.1	144.3	188.5	238.6
	PE30 ‡	Low	0.2	0.45	0.6	0.9	1	1.3	2.2	3.2	4.1	6				
		High	2	4.5	6	9	10	13	22	32	41	60				
	PE46 ‡	Low	0.1	0.3	0.4	0.5	0.6	0.7	1.3	1.8	2.4	3.5	4.7	7.2	9.6	
		High	1.3	2.9	4.1	5.9	6.8	8.6	14	22	28	42	56	84	112	
	PE55 ‡	Low	0.1	0.2	0.3	0.4	0.4	0.6	0.9	1.4	1.8	2.6	3.5	5.4	7.2	
	PE60 ‡	High	1.4	2.4	3.4	4.8	5.6	7.1	12	17.8	23	34	45	69	92	
	PQ60	Low	0.1	0.2	0.3	0.4	0.4	0.5	0.9	1.3	1.7	2.5	3.4	5.1	6.8	8.5
		High	1	2.2	3.3	4.4	5.2	6.5	11	16.2	21	31	41	63	84	105
	PQ120	Low	0.1	0.2	0.3	0.4	0.4	0.5	0.9	1.3	1.7	2.5	3.4	5.1	6.8	8.5
		High	0.5	1.1	1.6	2.2	2.6	3.2	5.5	7.7	10	15	21	30	40	50
PE400	Low	0.1	0.1	0.2	0.2	0.3	0.3	0.6	8	1	1.5	2.1	3	4	5	
	High	0.1	0.3	0.4	0.6	0.7	0.9	1.6	2.2	2.9	4.4	5.9	8.7	11.6	14.5	
Air/Hydraulic Pumps †	PA6 ‡	Single	10	22.4	31	44.4	51.3	65.2								
	PA9 ‡	Single	10	22.4	31	44.4	51.3	65.2								
	PA17 ‡	Low	0.2	0.5	0.7	0.9	1.1	1.4	2.3	3.3	4.3	6.5	8.7			
		High	3.5	7.9	10.9	16	18	23	39	56	73	109	146			
PA46 ‡	Low	0.1	0.3	0.4	0.5	0.6	0.7	1.3	2	2.4	3.5	4.7	7.2	9.6		
	High	1.3	2.9	4.1	5.9	6.8	8.6	14	22	28	42	56	84	112		
PA55 ‡	Low	0.1	0.3	0.4	0.6	0.7	0.9	1.5	2.2	2.8	4.1	5.5	8.4	11.2		
	High	1.1	2.4	3.4	4.8	5.6	7.1	12	18	26	34	45	69	92		
PG30	Low	0.3	0.7	1	1.3	1.6	2	3.3	4.8	6.2	9.3	12.4	18.1			
	High	2	4.5	6.3	8.9	10.3	13	22	31.8	41.3	61.4	83	121			
PG55 ‡	Low	0.1	0.3	0.4	0.6	0.7	0.8	1.4	2	2.6	3.9	5.2	7.6	9.9	12.5	
	High	1.1	2.5	3.5	4.9	5.6	7.1	12.1	17.3	22.5	33.5	45	66	86	109	
PG120 ‡	Low	0.1	0.3	0.4	0.6	0.7	0.8	1.4	2	2.6	3.9	5.2	7.6	9.9	12.5	
	High	0.5	1.0	1.5	2.0	2.4	3.0	5.1	7.3	9.5	14.2	19.1	27.8	36.3	46.0	
PG400	Low	0.1	0.1	0.2	0.2	0.3	0.3	0.6	0.8	1.0	1.5	2.0	3.0	3.8	4.9	
	High	0.2	0.3	0.5	0.7	0.8	1.0	1.7	2.4	3.1	4.6	6.2	9.0	11.8	15.0	

* Hand Pumps = Number of strokes required to move piston 1".

† Air, Electric and Gasoline Engine/Hydraulic pumps = Number of seconds required to move piston 1".

‡ Some Power Team pumps are available in special configurations not listed in this catalog. Power Team can "Assemble to order" pumps with special seals, voltages, valves, relief valve settings, etc. For your special requirements, please consult your local distributor or the Power Team factory.



INFO SECTION CHOOSING A CYLINDER BY TONNAGE

	Stroke (in.)	Retracted Height (in.)	Cylinder Movement	Order No.	Page No.
2 Ton Pull	5.00	9.19	SA	RP25	14
5 Ton Pull	5.50	11.88	SA	RP55	14
5 Ton	0.56	1.63	SA	RLS50	18
	1.00	4.38	SA	C51C	12
	3.25	6.50	SA	C53C	12
	5.25	8.50	SA	C55C	12
	5.25	10.50	SA	C55CBT	13
	7.25	10.75	SA	C57C	12
	9.25	12.75	SA	C59C	12
10 Ton	0.44	1.75	SA	RLS100	18
	1.00	3.63	SA	C101C	12
	1.50	3.50	SA	RSS101	20
	2.13	4.75	SA	C102C	12
	2.50	5.25	SA	RH102	21
	4.13	6.75	SA	C104C	12
	6.13	9.75	SA	C106C	12
	6.13	11.50	SA	C106CBT	13
	6.25	11.69	DA	RD106	34
	8.00	11.31	SA	RH108	21
	8.13	11.75	SA	C108C	12
	10.00	15.69	DA	RD1010	34
	10.13	13.75	SA	C1010C	12
	10.13	15.50	SA	C1010CBT	13
12.13	15.75	SA	C1012C	12	
14.13	17.75	SA	C1014C	12	
12 Ton	0.31	2.19	SA	RH120	21
	1.63	4.81	SA	RH121	21
	1.63	4.81	SA	RH121T	21
	3.00	7.25	SA	RH123	21
15 Ton	1.00	4.88	SA	C151C	12
	2.13	5.88	SA	C152C	12
	4.13	7.88	SA	C154C	12
	6.13	10.69	SA	C156C	12
	8.13	12.69	SA	C158C	12
	10.13	14.69	SA	C1510C	12
	12.13	16.69	SA	C1512C	12
	14.13	18.69	SA	C1514C	12
16.00	20.56	SA	C1516C	12	
17.5 Ton	2.00	6.88	DA	RT172	24
20 Ton	0.44	2.00	SA	RLS200	18
	1.75	3.75	SA	RSS202	20
	2.00	6.13	SA	RH202	21
	2.13	6.38	SA	RA202	17
	3.00	6.06	SA	RH203	21
	4.13	8.38	SA	RA204	17
	6.00	12.13	SA	RH206	21
6.13	10.38	SA	RA206	17	
25 Ton	1.00	5.50	SA	C251C	12
	2.00	6.50	SA	C252C	12
	4.00	8.50	SA	C254C	12
	6.25	10.75	SA	C256C	12
	6.25	13.38	SA	C256CBT	13
	6.25	12.38	DA	RD256	34
	8.25	12.75	SA	C258C	12
	10.25	14.75	SA	C2510C	12
	12.25	16.75	SA	C2512C	12
	14.13	18.75	SA	C2514C	12
	14.13	20.38	DA	RD2514	34
14.13	21.38	SA	C2514CBT	13	

SA - Single-Acting
DA - Double-Acting

	Stroke (in.)	Retracted Height (in.)	Cylinder Movement	Order No.	Page No.
30 Ton	0.50	2.31	SA	RLS300	18
	2.13	7.38	SA	RA302	17
	2.44	4.63	SA	RSS302	20
	2.50	6.25	SA	RH302	21
	2.50	8.44	DA	RT302	24
	3.00	7.06	SA	RH303	22
	4.13	9.38	SA	RA304	17
	5.88	11.13	SA	RHA306	21
	6.00	9.75	SA	RH306	21
	6.00	11.06	DA	RH306D	22
	6.13	11.38	SA	RA306	17
8.25	12.80	SA	C308C	12	
10.13	17.25	DA	RH3010	22	
50 Ton	0.63	2.63	SA	RLS500S	18
	2.38	5.00	SA	RSS502	20
	3.00	7.13	SA	RH503	21
	3.00	10.56	DA	RT503	24
55 Ton	2.00	4.94	SA	R552C	35
	2.00	6.38	SA	R552L	40
	2.00	6.88	SA	C552C	12
	2.00	7.84	DA	RDG552	30
	2.00	7.84	SA	RGG552	26
	2.13	6.75	SA	RA552	17
	4.00	9.84	DA	RDG554	30
	4.00	9.84	SA	RGG554	26
	4.13	8.75	SA	RA554	17
	4.25	9.13	SA	C554C	12
	6.00	8.94	SA	R556C	35
	6.00	10.38	SA	R556L	40
	6.00	11.84	DA	RDG556	30
	6.00	11.84	SA	RGG556	26
	6.13	10.75	SA	RA556	17
	6.13	12.50	SA	RA556L	39
	6.25	11.13	SA	C556C	12
	6.25	12.97	DA	RD556	34
	8.00	13.84	DA	RDG558	30
	8.00	13.84	SA	RGG558	26
10.00	12.95	SA	R5510C	35	
10.00	14.38	SA	R5510L	40	
10.00	15.13	SA	RA5510	17	
10.00	15.84	DA	RDG5510	30	
10.00	15.84	SA	RGG5510	26	
10.25	15.13	SA	C5510C	12	
12.00	17.84	DA	RDG5512	30	
12.00	17.84	SA	RGG5512	26	
13.00	18.84	DA	RDG5513	30	
13.00	18.84	SA	RGG5513	26	
13.13	19.84	DA	RD5513	34	
13.25	18.13	SA	C5513C	12	
14.00	19.84	DA	RDG5514	30	
14.00	19.84	SA	RGG5514	26	
18.13	25.88	DA	RD5518	34	
60 Ton	3.00	9.25	SA	RH603	21
	4.00	9.50	DA	RHA604D	22
	5.00	9.50	DA	RH605	22
	6.00	12.50	SA	RH606	21
10.13	18.06	DA	RH6010	22	
75 Ton	0.63	3.13	SA	RLS750S	18
	2.00	8.31	DA	RDG752	30
	2.00	8.31	SA	RGG752	26
	4.00	10.31	DA	RDG754	30
	4.00	10.31	SA	RGG754	26
	6.00	12.31	DA	RDG756	30
	6.00	12.31	SA	RGG756	26
	6.13	12.38	SA	C756C	12
	8.00	14.31	DA	RDG758	30
	8.00	14.31	SA	RGG758	26

	Stroke (in.)	Retracted Height (in.)	Cylinder Movement	Order No.	Page No.
75 Ton	10.00	16.31	DA	RDG7510	30
	10.00	16.31	SA	RGG7510	26
	12.00	18.31	DA	RDG7512	30
	12.00	18.31	SA	RGG7512	26
	13.00	19.31	DA	RDG7513	30
	13.00	19.31	SA	RGG7513	26
	13.13	19.38	SA	C7513C	12
	14.00	20.31	DA	RDG7514	30
14.00	20.31	SA	RGG7514	26	
80 Ton	13.13	20.38	DA	RD8013	34
100 Ton	0.63	3.38	SA	RLS1000S	18
	1.50	5.69	SA	RSS1002D	20
	1.50	6.50	DA	RH1001	22
	2.00	5.50	SA	R1002C	35
	2.00	6.64	DA	R1002D	36
	2.00	7.25	SA	R1002L	40
	2.00	8.63	SA	C1002C	12
	2.00	8.70	DA	RDG1002	30
	2.00	8.70	SA	RGG1002	26
	2.13	7.75	SA	RA1002	17
	2.25	5.50	SA	RSS1002	20
	3.00	10.00	SA	RH1003	21
	4.00	10.70	DA	RDG1004	30
	4.00	10.70	SA	RGG1004	26
	4.88	15.13	DA	RT1004	24
	6.00	9.50	SA	R1006C	35
	6.00	10.64	DA	R1006D	36
	6.00	11.25	SA	R1006L	40
	6.00	12.38	DA	RH1006	22
	6.00	12.70	DA	RDG1006	30
	6.00	12.70	SA	RGG1006	26
	6.25	11.75	SA	RA1006	17
	6.25	13.38	SA	RA1006L	39
	6.63	13.25	SA	C1006C	12
	6.63	13.78	DA	RD1006	34
	8.00	14.70	DA	RDG1008	30
	8.00	14.70	SA	RGG1008	26
10.00	14.64	DA	R10010D	36	
10.00	15.25	SA	R10010L	40	
10.00	16.70	DA	RDG10010	30	
10.00	16.70	SA	RGG10010	26	
10.13	19.81	DA	RH10010	22	
10.25	15.63	SA	RA10010	17	
10.25	16.88	SA	C10010C	12	
12.00	18.70	DA	RDG10012	30	
12.00	18.70	SA	RGG10012	26	
13.00	19.70	DA	RDG10013	30	
13.00	19.70	SA	RGG10013	26	
13.13	20.28	DA	RD10013	34	
14.00	20.70	DA	RDG10014	30	
14.00	20.70	SA	RGG10014	26	
20.13	28.28	DA	RD10020	34	
150 Ton	0.56	4.00	SA	RLS1500S	18
	2.00	6.38	SA	R1502C	35
	2.00	7.44	DA	R1502D	36
	2.00	8.13	SA	R1502L	40
	2.00	9.37	DA	RDG1502	30
	2.00	9.37	SA	RGG1502	26
	4.00	11.37	DA	RDG1504	30
	4.00	11.37	SA	RGG1504	26
	5.00	12.13	DA	RH1505	22
	6.00	10.38	SA	R1506C	35
	6.00	11.44	DA	R1506D	36
6.00	12.13	SA	R1506L	40	
6.00	13.37	DA	RDG1506	30	



	Stroke (in.)	Retracted Height (in.)	Cylinder Movement	Order No.	Page No.
150 Ton	6.00	13.37	SA	RGG1506	26
	6.63	14.88	DA	RD1506	34
	8.00	13.75	DA	RH1508	22
	8.00	15.37	DA	RDG1508	30
	8.00	15.37	SA	RGG1508	26
	10.00	14.38	SA	R15010C	35
	10.00	16.13	SA	R15010L	40
	10.00	17.37	DA	RDG15010	30
	10.00	17.37	SA	RGG15010	26
	12.00	19.37	DA	RDG15012	30
	12.00	19.37	SA	RGG15012	26
	13.00	20.37	DA	RDG15013	30
	13.00	20.37	SA	RGG15013	26
	13.13	21.38	DA	RD15013	34
	14.00	21.37	DA	RDG15014	30
	14.00	21.37	SA	RGG15014	26
	18.13	26.53	DA	RD15018	34
	200 Ton	2.00	7.50	SA	R2002C
2.00		8.14	DA	R2002D	36
2.00		9.50	SA	R2002L	40
2.00		10.04	DA	RDG2002	30
2.00		10.04	SA	RGG2002	26
4.00		12.04	DA	RDG2004	30
4.00		12.04	SA	RGG2004	26
6.00		11.50	SA	R2006C	35
6.00		12.14	DA	R2006D	36
6.00		13.50	SA	R2006L	40
6.00		14.04	DA	RDG2006	30
6.00		14.04	SA	RGG2006	26
6.63		16.00	DA	RD2006	34
8.00		15.50	SA	R2008L	40
8.00		16.06	DA	RH2008	22
8.00		16.04	DA	RDG2008	30
8.00		16.04	SA	RGG2008	26
10.00		16.14	DA	R20010D	36
10.00		18.04	DA	RDG20010	30
10.00		18.04	SA	RGG20010	26
13.00	20.04	DA	RDG20013	30	
13.00	20.04	SA	RGG20013	26	
13.13	22.50	DA	RD20013	34	
14.00	22.04	DA	RDG20014	30	
14.00	22.04	SA	RGG20014	26	
18.13	28.50	DA	RD20018	34	
250 Ton	2.00	10.30	DA	RDG2502	32
	2.00	10.30	SA	RGG2502	28
	3.00	11.44	SA	RSS2503	20
	4.00	12.30	DA	RDG2504	32
	4.00	12.30	SA	RGG2504	28
	6.00	14.30	DA	RDG2506	32
	6.00	14.30	SA	RGG2506	28
	8.00	16.30	DA	RDG2508	32
	8.00	16.30	SA	RGG2508	28
	10.00	18.30	DA	RDG25010	32
	10.00	18.30	SA	RGG25010	28
	12.00	20.30	DA	RDG25012	32
	12.00	20.30	SA	RGG25012	28
	13.00	21.30	DA	RDG25013	32
	13.00	21.30	SA	RGG25013	28
	14.00	22.30	DA	RDG25014	32
	14.00	22.30	SA	RGG25014	28

	Stroke (in.)	Retracted Height (in.)	Cylinder Movement	Order No.	Page No.	
280 Ton	2.00	7.50	SA	R2802C	35	
	2.00	9.20	DA	R2802D	36	
	2.00	9.75	SA	R2802L	40	
	6.00	11.50	SA	R2806C	35	
	6.00	13.20	DA	R2806D	36	
	6.00	13.75	SA	R2806L	40	
	10.00	17.20	DA	R28010D	36	
	10.00	17.75	SA	R28010L	40	
	300 Ton	2.00	10.74	DA	RDG3002	32
		2.00	10.74	SA	RGG3002	28
4.00		12.74	DA	RDG3004	32	
4.00		12.74	SA	RGG3004	28	
6.00		14.74	DA	RDG3006	32	
6.00		14.74	SA	RGG3006	28	
6.00		17.28	DA	RD3006	34	
8.00		16.74	DA	RDG3008	32	
8.00		16.74	SA	RGG3008	28	
10.00		18.74	DA	RDG30010	32	
10.00		18.74	SA	RGG30010	28	
12.00		20.74	DA	RDG30012	32	
12.00		20.74	SA	RGG30012	28	
13.00		21.74	DA	RDG30013	32	
13.00	21.74	SA	RGG30013	28		
13.00	24.81	DA	RD30013	34		
14.00	22.74	DA	RDG30014	32		
14.00	22.74	SA	RGG30014	28		
355 Ton	2.00	9.13	SA	R3552C	35	
	2.00	11.38	DA	R3552D	36	
	2.00	11.50	SA	R3552L	40	
	6.00	13.13	SA	R3556C	35	
	6.00	15.38	DA	R3556D	36	
	6.00	15.50	SA	R3556L	40	
400 Ton	2.00	12.07	DA	RDG4002	32	
	2.00	12.07	SA	RGG4002	28	
	4.00	14.07	DA	RDG4004	32	
	4.00	14.07	SA	RGG4004	28	
	6.00	16.07	DA	RDG4006	32	
	6.00	16.07	SA	RGG4006	28	
	6.00	19.28	DA	RD4006	34	
	8.00	18.07	DA	RDG4008	32	
	8.00	18.07	SA	RGG4008	28	
	10.00	20.07	DA	RDG40010	32	
	10.00	20.07	SA	RGG40010	28	
	12.00	22.07	DA	RDG40012	32	
	12.00	22.07	SA	RGG40012	28	
	13.00	23.07	DA	RDG40013	32	
13.00	23.07	SA	RGG40013	28		
13.00	26.28	DA	RD40013	34		
14.00	24.07	DA	RDG40014	32		
14.00	24.07	SA	RGG40014	28		
430 Ton	2.00	10.38	SA	R4302C	35	
	2.00	12.31	DA	R4302D	36	
	2.00	13.13	SA	R4302L	40	
	6.00	14.38	SA	R4306C	35	
	6.00	16.31	DA	R4306D	36	
	6.00	17.13	SA	R4306L	40	
	10.00	20.31	DA	R43010D	36	
	10.00	21.13	SA	R43010L	40	

	Stroke (in.)	Retracted Height (in.)	Cylinder Movement	Order No.	Page No.
500 Ton	2.00	12.28	DA	RDG5002	32
	2.00	12.28	SA	RGG5002	28
	4.00	12.28	DA	RDG5004	32
	4.00	14.28	SA	RGG5004	28
	6.00	16.28	DA	RDG5006	32
	6.00	16.28	SA	RGG5006	28
	6.00	20.56	DA	RD5006	34
	8.00	18.28	DA	RDG5008	32
	8.00	18.28	SA	RGG5008	28
	10.00	20.28	DA	RDG50010	32
	10.00	20.28	SA	RGG50010	28
	12.00	22.28	DA	RDG50012	32
	12.00	22.28	SA	RGG50012	28
	13.00	23.28	DA	RDG50013	32
	13.00	23.28	SA	RGG50013	28
	13.00	27.56	DA	RD50013	34
	14.00	24.28	DA	RDG50014	32
	14.00	24.28	SA	RGG50014	28
565 Ton	2.00	11.50	SA	R5652C	35
	2.00	13.59	DA	R5652D	36
	2.00	14.63	SA	R5652L	40
	6.00	15.50	SA	R5656C	35
	6.00	17.59	DA	R5656D	36
	6.00	18.63	SA	R5656L	40
	10.00	19.50	SA	R56510C	35
	10.00	21.59	DA	R56510D	36
	10.00	22.63	SA	R56510L	40
	600 Ton	2.00	12.76	DA	RDG6002
2.00		12.76	SA	RGG6002	28
4.00		14.76	DA	RDG6004	32
4.00		14.76	SA	RGG6004	28
6.00		16.76	DA	RDG6006	32
6.00		16.76	SA	RGG6006	28
8.00		18.76	DA	RDG6008	32
8.00		18.76	SA	RGG6008	28
10.00		20.76	DA	RDG60010	32
10.00		20.76	SA	RGG60010	28
12.00		22.76	DA	RDG60012	32
12.00		22.76	SA	RGG60012	28
13.00		23.76	DA	RDG60013	32
13.00		23.76	SA	RGG60013	28
14.00	24.76	DA	RDG60014	32	
14.00	24.76	SA	RGG60014	28	
740- 1220 Ton	2,6,10	—	SA	RC_C	37
	2,6,10	—	DA	RC_D	38
	2,6,10	—	SA	RC_L	42

SA - Single-Acting
DA - Double-Acting

Model Shown:
C756C



>Features

RUGGED, HIGH QUALITY CYLINDER USED FOR LIFTING AND PRESSING.

- Aluminum bronze bearing reduces wear caused by off-center loads.
- Maximum sized springs speed piston return and increase spring life.
- Collar threads are standard on all C-Series models, simplifying fixturing applications.
- Removable rubber boots protect collar threads during transport and storage.
- Solid steel cylinder body for durability.
- Chrome plated piston rod resists wear and corrosion.
- Wide range of accessories available that mount onto the piston rod, collar, or base.
- Base mounting holes standard on 5 through 55 ton cylinders and optional on 75 and 100 ton cylinders.
- A 3/8" NPTF female half coupler is standard.
- Complies with ANSI / ASME B30.1 Safety Standards.

▶ **C10010C used in this pulling application.**



Best Practice for Cylinder Selection



Power Team recommends using 80% of the rated capacity and stroke to maximize product performance and safety.



**Optional Cylinders
Lifting Handle**



Order Number: 4206550R9

Lifting handle for "C" series, 25 ton cylinders

▶ **Technical Dimensions, Base Mounting Holes**

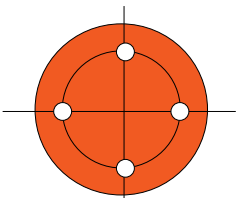

Four base mounting holes are 45° apart - standard on all models.

Cylinder Tonnage	5	10	15	25	30	55	75*	100*
# of Holes	2	2	2	2	2	2	4	4
Thread Size	1/4 - 20	5/16 - 18	3/8 - 16	1/2 - 13	1/2-13	1/2 - 13	3/4 - 10	1 - 8
Thread Depth (in.)	0.38	0.50	0.50	0.75	0.75	0.75	1.00	1.00
Bolt Circle Diameter (in.)	1.00	1.56	1.88	2.31	2.90	3.75	4.50	4.75

* Consult Factory for optional base mounting holes.

Technical Dimensions

Cylinder Load Caps furnished with "C" Series Cylinders:

5 ton cylinders	No. 201375
10 ton cylinders	No. 201362
15 ton cylinders	No. 201362
25 ton cylinders	No. 201412
55 ton cylinders	No. 36161
75 ton cylinders	No. 36161
100 ton cylinders	No. 36161

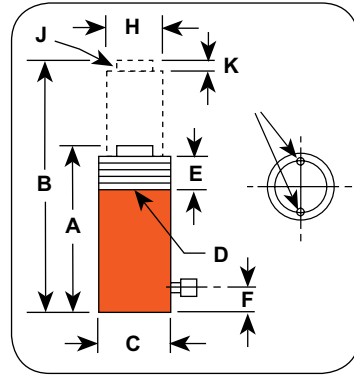

C10010C used in this lift application.



Cylinders

Ordering Information

Cyl. Cap.	Stroke	Order No.	Oil Cap.	A	B	C	D	E	F	H	J	K	Bore Dia.	Cylinder Effective Area	Int. Press. at Cap.	Tons at 10,000	Prod. Wt.
				Re-tract-ed Height (in.)	Ex-tend-ed Height (in.)	Outside Dia. (in.)	Collar Thread (in.)	Piston Collar Thread Length (in.)	Base to Port (in.)	Pis-ton Rod Dia. (in.)	Piston Rod Int. Thread and Depth (in.)	Rod Pro-trusion (in.)					
Tons	(in.)		(cu. in.)	(in.)	(in.)	(in.)	(in.)	(in.)	(in.)	(in.)	(in.)	(in.)	(in.)	(sq. in)	(psi)	(tons)	(lbs.)
5	1.00	C51C	1.10	4.34	5.44	1.50	1 1/2-16	1.13	0.75	1.00	3/4-16 x 0.63	0.25	1.13	0.994	10,061	4.97	2.25
	3.25	C53C	3.20	6.50	9.75	1.50	1 1/2-16	1.13	0.75	1.00	3/4-16 x 0.63	0.25	1.13	0.994	10,061	4.97	3.26
	5.25	C55C	5.20	8.50	13.75	1.50	1 1/2-16	1.13	0.75	1.00	3/4-16 x 0.63	0.25	1.13	0.994	10,061	4.97	4.00
	7.25	C57C	7.20	10.75	18.00	1.50	1 1/2-16	1.13	0.75	1.00	3/4-16 x 0.63	0.25	1.13	0.994	10,061	4.97	5.00
	9.25	C59C	9.20	12.75	22.00	1.50	1 1/2-16	1.13	0.75	1.00	3/4-16 x 0.63	0.25	1.13	0.994	10,061	4.97	5.80
10	1.00	C101C	2.20	3.63	4.63	2.25	2 1/4-14	1.13	0.75	1.50	1-8 x 0.75	0.25	1.69	2.236	8,948	11.20	4.00
	2.13	C102C	4.80	4.75	6.88	2.25	2 1/4-14	1.13	0.75	1.50	1-8 x 0.75	0.25	1.69	2.236	8,948	11.20	5.00
	4.13	C104C	9.20	6.75	10.88	2.25	2 1/4-14	1.13	0.75	1.50	1-8 x 0.75	0.25	1.69	2.236	8,948	11.20	6.70
	6.13	C106C	13.70	9.75	15.88	2.25	2 1/4-14	1.13	0.75	1.50	1-8 x 0.75	0.25	1.69	2.236	8,948	11.20	9.40
	8.13	C108C	19.90	11.75	19.88	2.25	2 1/4-14	1.13	0.75	1.50	1-8 x 0.75	0.25	1.69	2.236	8,948	11.20	11.00
	10.13	C1010C	22.60	13.75	23.88	2.25	2 1/4-14	1.13	0.75	1.50	1-8 x 0.75	0.25	1.69	2.236	8,948	11.20	13.00
	12.13	C1012C	27.10	15.75	27.88	2.25	2 1/4-14	1.13	0.75	1.50	1-8 x 0.75	0.25	1.69	2.236	8,948	11.20	14.60
	14.13	C1014C	31.60	17.75	31.88	2.25	2 1/4-14	1.13	0.75	1.50	1-8 x 0.75	0.25	1.69	2.236	8,948	11.20	16.20
16.00	C1016C	36.10	20.50	36.50	2.25	2 1/4-14	1.13	0.75	1.50	1-8 x 0.75	0.25	1.69	2.236	8,948	11.20	18.50	
15	1.00	C151C	3.10	4.88	5.88	2.75	2 3/4-16	1.13	0.75	1.75	1-8 x 0.75	0.25	2.00	3.142	9,549	15.70	7.50
	2.13	C152C	6.70	5.88	8.00	2.75	2 3/4-16	1.13	0.75	1.75	1-8 x 0.75	0.25	2.00	3.142	9,549	15.70	8.90
	4.13	C154C	12.90	7.88	12.00	2.75	2 3/4-16	1.13	0.75	1.75	1-8 x 0.75	0.25	2.00	3.142	9,549	15.70	11.50
	6.13	C156C	19.20	10.69	16.81	2.75	2 3/4-16	1.13	0.75	1.75	1-8 x 0.75	0.25	2.00	3.142	9,549	15.70	15.30
	8.13	C158C	25.50	12.69	20.81	2.75	2 3/4-16	1.13	0.75	1.75	1-8 x 0.75	0.25	2.00	3.142	9,549	15.70	17.90
	10.13	C1510C	31.80	14.69	24.81	2.75	2 3/4-16	1.13	0.75	1.75	1-8 x 0.75	0.25	2.00	3.142	9,549	15.70	20.70
	12.13	C1512C	38.10	16.69	28.81	2.75	2 3/4-16	1.13	0.75	1.75	1-8 x 0.75	0.25	2.00	3.142	9,549	15.70	23.20
	14.13	C1514C	44.40	18.69	32.81	2.75	2 3/4-16	1.13	0.75	1.75	1-8 x 0.75	0.25	2.00	3.142	9,549	15.70	26.00
16.00	C1516C	50.30	20.56	36.56	2.75	2 3/4-16	1.13	0.75	1.75	1-8 x 0.75	0.25	2.00	3.142	9,549	15.70	28.20	
25	1.00	C251C	5.10	5.50	6.50	3.38	3 5/16-12	1.94	1.00	2.25	1 1/2-16 x 0.88	0.38	2.56	5.15	9,699	25.80	11.90
	2.00	C252C	10.30	6.50	8.50	3.38	3 5/16-12	1.94	1.00	2.25	1 1/2-16 x 0.88	0.38	2.56	5.15	9,699	25.80	13.90
	4.00	C254C	20.60	8.50	12.50	3.38	3 5/16-12	1.94	1.00	2.25	1 1/2-16 x 0.88	0.38	2.56	5.15	9,699	25.80	17.60
	6.25	C256C	32.20	10.75	17.00	3.38	3 5/16-12	1.94	1.00	2.25	1 1/2-16 x 0.88	0.38	2.56	5.15	9,699	25.80	21.70
	8.25	C258C	42.50	12.75	21.00	3.38	3 5/16-12	1.94	1.00	2.25	1 1/2-16 x 0.88	0.38	2.56	5.15	9,699	25.80	25.60
	10.25	C2510C	52.80	14.75	25.00	3.38	3 5/16-12	1.94	1.00	2.25	1 1/2-16 x 0.88	0.38	2.56	5.15	9,699	25.80	29.30
	12.25	C2512C	63.20	16.75	29.00	3.38	3 5/16-12	1.94	1.00	2.25	1 1/2-16 x 0.88	0.38	2.56	5.15	9,699	25.80	33.10
14.25	C2514C	73.50	18.75	33.00	3.38	3 5/16-12	1.94	1.00	2.25	1 1/2-16 x 0.88	0.38	2.56	5.15	9,699	25.80	36.80	
30	8.25	C308C	53.55	12.80	21.05	4.00	4-12	2.00	1.00	2.50	1 1/2-16 x 0.88	0.38	2.87	6.46	9,243	32.50	36.5
55	2.00	C552C	22.10	6.88	8.88	5.00	5-12	2.19	1.38	3.13	None	0.13	3.75	11.04	9,959	55.20	32.50
	4.25	C554C	46.90	9.13	13.38	5.00	5-12	2.19	1.38	3.13	None	0.13	3.75	11.04	9,959	55.20	41.30
	6.25	C556C	69.00	11.13	17.38	5.00	5-12	2.19	1.38	3.13	None	0.13	3.75	11.04	9,959	55.20	51.00
	10.25	C5510C	113.20	15.13	25.38	5.00	5-12	2.19	1.38	3.13	None	0.13	3.75	11.04	9,959	55.20	67.00
	13.25	C5513C	146.30	18.13	31.38	5.00	5-12	2.19	1.38	3.13	None	0.13	3.75	11.04	9,959	55.20	78.00
75	6.13	C756C	97.40	12.38	18.50	5.75	5 3/4-12	1.75	1.25	3.75	None	0.13	4.50	15.90	9,434	79.50	73.50
	13.13	C7513C	208.70	19.38	32.50	5.75	5 3/4-12	1.75	1.25	3.75	None	0.13	4.50	15.90	9,434	79.50	109.50
100	2.00	C1002C	41.20	8.63	10.63	6.25	6 1/4-12	2.25	1.63	4.13	None	0.13	5.13	20.62	9,695	103.10	63.00
	6.63	C1006C	137.00	13.25	19.88	6.25	6 1/4-12	2.25	1.63	4.13	None	0.13	5.13	20.62	9,695	103.10	91.00
	10.25	C10010C	211.50	16.88	27.13	6.25	6 1/4-12	2.25	1.63	4.13	None	0.13	5.13	20.62	9,695	103.10	113.00

Model Shown:
C55CBT, C2514CBT



Features

THREADED PISTON ROD END AND BASE THREADS ACCOMMODATE ACCESSORIES AND ADAPTERS.

- Threaded cylinder collars, piston rod ends, and internal base threads simplify mounting.
- A 9796 3/8" NPTF female half coupler is standard with each cylinder. Oil port threads are 3/8" NPTF.
- Removable threaded rod cap.
- Factory accessories are do not de-rate tonnage.
- Complies with ANSI / ASME B30.1 Safety Standards.



Versatility and fixturing capabilities

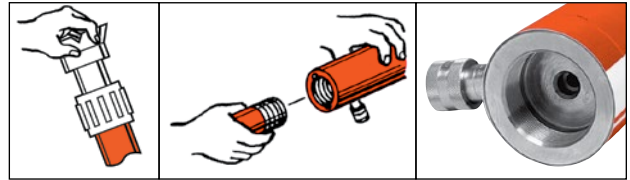

Analog Gauges



Improve your system visibility and safety by adding an inline hydraulic gauge to your circuit.

9440 (2.5 in.), **9052** (4 in.), and **9089** (6 in.)

Technical Dimensions

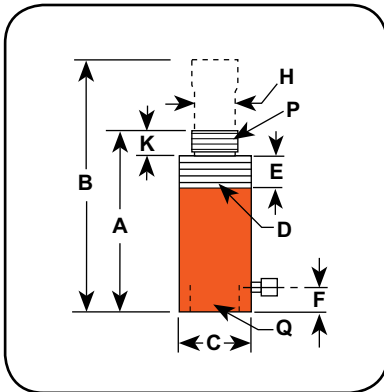

Ordering Information

Cyl. Cap.	Stroke	Order No.	Oil Cap.	A	B	C	D	E	F	H	K	P	Q	Bore Dia.	Cylinder Effective Area	Int. Press. at Cap.	Tons at 10,000	Prod. Wt.
				Re-tracted Height	Ex-tended Height	Outside Dia.	Collar Thread	Collar Thread Length	Base to Port	Piston Rod Dia.	Piston Rod Protru-sion	Piston Rod Thread	Internal Base Thread (NPSM)					
(tons)	(in.)		(cu. in.)	(in.)	(in.)	(in.)	(in.)	(in.)	(in.)	(in.)	(in.)	(NPT)	(in.)	(in.)	(sq. in.)	(psi)	(tons)	(lbs.)
5	5.25	C55CBT	5.25	10.50	15.75	1.50	1 1/2-16	1.13	1.88	1.00	1.13	3/4-14	3/4-14	1.13	0.99	10,061	4.97	4.40
10	6.13	C106CBT	13.90	11.50	17.63	2.25	2 1/4-14	1.13	1.69	1.50	1.06	1 1/4-11.5	1 1/4-11.5	1.69	2.24	8,948	11.20	10.30
	10.13	C1010CBT	22.90	15.50	25.63	2.25	2 1/4-14	1.13	1.69	1.50	1.06	1 1/4-11.5	1 1/4-11.5	1.69	2.24	8,948	11.20	13.90
25	6.25	C256CBT	32.20	13.38	19.63	3.38	3 5/16-12	1.94	1.88	2.25	1.88	2-11.5	2-11.5	2.56	5.16	9,699	25.80	24.60
	14.25	C2514CBT	73.50	21.38	35.63	3.38	3 5/16-12	1.94	1.88	2.25	1.88	2-11.5	2-11.5	2.56	5.16	9,699	25.80	40.20

Model Shown:
RP25, RP55



Technical Dimensions

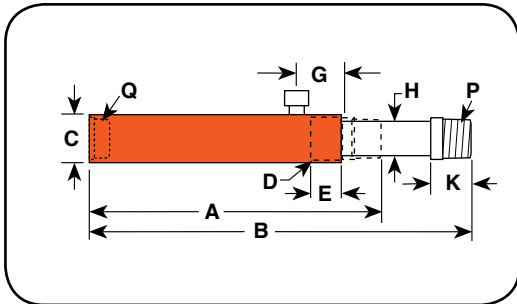

Ordering Information

Cyl. Cap.	Stroke	Order No.	Oil Cap.	A	B	C	D	E	G	H	K	P	Q	Bore Dia.	Cylinder Effective Area	Int. Press. at Cap.	Tons at 10,000	Prod. Wt.
				Re-tract-ed Height	Ex-tend-ed Height	Outside Dia.	Collar Thread	Collar Thread Length	Cyl. Top to Port	Piston Rod Dia.	Piston Rod Protru-sion	Piston Rod Thread	Base Thread					
(tons)	(in.)		(cu. in.)	(in.)	(in.)	(in.)	(in.)	(in.)	(in.)	(in.)	(in.)	(NPT)	(NPT)	(in.)	(sq. in.)	(psi)	(tons)	(lbs.)
2	5.00	RP25	2.76	9.38	14.56	1.75	1 1/2 - 16	1.00	1.69	0.75	1.00	3/4 - 14	3/4 - 14	1.13	0.55	7,250	2.75	4.00
5	5.50	RP55	6.22	11.88	17.38	2.25	2 1/4 - 14	1.00	1.69	1.19	1.38	1 1/4 - 11 1/2	1 1/4 - 11 1/2	1.69	1.13	8,850	5.65	11.00

Features

DESIGNED FOR PULLING AND TENSIONING APPLICATIONS.

- Heavy-duty compression spring provides long cycle life and rapid extension of piston.
- Spring automatically extends piston rod when pump pressure is released.
- Complies with ANSI / ASME B30.1 Safety Standards.



Clevis Ordering Information

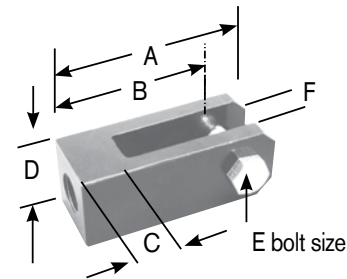

Use with Cyl. No.	Order No.	A (in.)	B (in.)	C (in.)	D (in.)	E (in.)	F (in.)
RP25	421057 *	5.13	4.31	1.31	2.00	0.75	1.00
RP55	421056**	6.00	5.00	1.50	2.50	0.88	1.25

* For base mounting, extension rod 351106 is required.

** For base mounting, extension rod 351075 is required.



Learn More - About Hydraulic Safety Insight



Looking for great safety suggestions? Visit our Resource Section to get a better understanding of hydraulic and mechanical safety insights on what to look for when working around hydraulics.

▶ **Support Base**

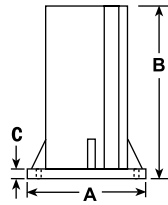

Cylinder Tons	Part No.	A (in.)	B (in.)	C (in.)
10	420062	7	5	7/16
25	420063	7	5	7/16

▶ **Threaded Connector**

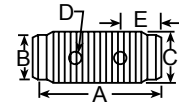

Cylinder Tons	Part No.	A (in.)	B (in.)	C (in.)	D (in.)	E (in.)
5	25748	1.75	0.88 Dia.	3/4 - 14 NPSM	0.19 Dia.	0.50
10	25664	1.63	1.44 Dia.	1 1/4 - 11 1/2 NPSM	0.31 Dia.	0.56
25	25654	2.25	2.25 Dia.	2 - 11 1/2 NPSM	0.38 Dia.	0.63

▶ **Piston Clevis**

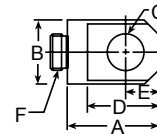

Cylinder Tons	Part No.	A (in.)	B (in.)	C (in.)	D (in.)	E (in.)	F (in.)
5	350095	1.75	1.13	0.63	1.44	0.63	3/4 - 16
10 or 15*	350094	2.56	1.69	1.25	2.31	1.00	1 - 8
25**	420059	2.94	2.25	2.00	2.69	1.25	1 1/2 - 16

* Can be used with RD106, RD1010 Cylinder.

** RD256 & RD2514

▶ **Swivel Cap**

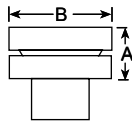

Cylinder Tons	Part No.	A (in.)	B (in.)
10 or 15	350144	0.88	1.38
25	350145	1.13	2.0
55 or 75	350376	1.25	2.81
100	351574	1.91	3.47

▶ **Threaded & Plain Adapters**

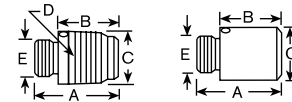

Cylinder Tons	Part No.	A (in.)	B (in.)	C (in.)	D (in.)	E (in.)
5	202178 (threaded)	1.63	1.13	1.06 Dia.	3/4 - 14 NPT	3/4 - 16 UNF-2A
10 or 15*	202179 (threaded)	1.81	1.06	1.63 Dia.	1 1/4 - 11 1/2 NPT	1 - 8 UNC-2A
25	202180 (threaded)	2.75	1.88	2.38 Dia.	2 - 11 1/2 NPT	1 1/2 - 16 UN-2A
10 or 15	350724 (plain)	2.00	1.25	1.48 Dia.	—	1 - 8 UNC-2A
25	350723 (plain)	2.13	1.25	2.25 Dia.	—	1 1/2 - 16 UN-2A

▶ **Cylinder Mounting Plate**

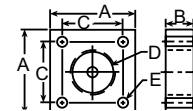

Cylinder Tons	Part No.	A (in.)	B (in.)	C (in.)	D (in.)	E (in.)
5	350099	3.00	1	2.13	1 1/2 - 16 UN-2B	0.34
10	350100	3.50	1	2.63	2 1/4 - 14 UNS-2B	0.34
15	350184	3.50	1	2.63	2 3/4 - 16 UN-2B	0.34
25	420064	5.00	2	3.97	3 5/16 - 12 UN-2B	0.66

▶ **Cylinder Flat Base**

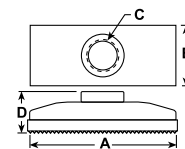

Cylinder Tons	Part No.	A (in.)	B (in.)	C (in.)	D (in.)
5	350095	4.50	2.50	3/4 - 14 NPSM	1.34
10 or 15*	350094	.375	3.50	1 1/4 - 11 1/2 NPSM	1.44

* Items require threaded adapter when used with "C" series cylinders. Can be used on threaded "CBT" cylinders without the use of an adapter.

► Extension Rod

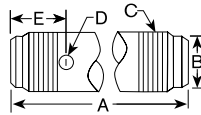

Cylinder Tons	Part No.	A (in.)	B (in.)	C (in.)	D (in.)	E (in.)
5	350895	5	0.88 Dia.	3/4 - 14 NPT	0.33 Dia.	2
5	38908	10	0.88 Dia.	3/4 - 14 NPT	0.33 Dia.	2
5	350896	18	0.88 Dia.	3/4 - 14 NPT	0.33 Dia.	2
10	350897	5	1.44 Dia.	1 1/4 - 11 1/2 NPT	0.33 Dia.	2
10	38909	10	1.44 Dia.	1 1/4 - 11 1/2 NPT	0.33 Dia.	2
10	350898	18	1.44 Dia.	1 1/4 - 11 1/2 NPT	0.33 Dia.	2

► 90° "V" Base

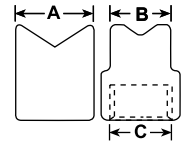
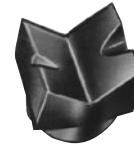

Cylinder Tons	Part No.	A (in.)	B (in.)	C (in.)
5	25388*	1.38	1.06	3/4 - 14 NPSM
10	25395*	2.13	2.13	1 1/4 - 14 NPSM

► Cylinder Base Attachment

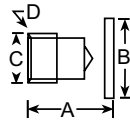

Cylinder Tons	Part No.	A (in.)	B (in.)	C (in.)	D (in.)
5	208380	1.63	1.75 Dia.	3/4 - 14 NPSM	0.28 Dia. (2) 1/4 - 20 UNC x 3/4 Lg. Socket Head Cap Screws
10	208381	1.88	2.50 Dia.	1 1/4 - 11 1/2 NPSM	0.34 Dia. (2) 5/16 - 18 UNC x 3/4 Lg. Socket Head Cap Screws
25	208382	2.38	3.38 Dia.	2 - 11 1/2 NPSM	0.53 Dia. (2) 1/2 - 13 UNC x 1 Lg. Socket Head Cap Screws

► Plunger Base

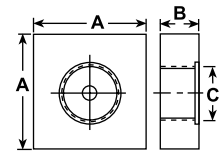
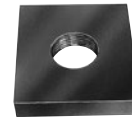

Cylinder Tons	Part No.	A (in.)	B (in.)	C (in.)
25	25652	6	1.25	2 - 11 1/2 NPSM

► Plain & Serrated Saddles

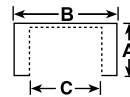
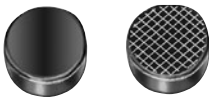

Cylinder Tons	Part No.	A (in.)	B (in.)	C (in.)
5	25746* (serrated)	1.13	1.31 Dia.	3/4 - 14 NPSM
10 or 15*	31772* (serrated)	1.13	2 Dia.	1 1/4 - 11 1/2 NPSM
25	31776* (serrated)	1.31	3 Dia.	2 - 11 1/2 NPSM
5	351575* (plain)	1.13	1.31 Dia.	3/4 - 14 NPSM
10	24016* (plain)	1.13	2 Dia.	1 1/4 - 11 1/2 NPSM
25	351576* (plain)	1.31	3 Dia.	2 - 11 1/2 NPSM

* Items require threaded adapter when used with "C" series cylinders. They may be used on threaded "CBT" cylinders without the use of an adapter.

► Body Clevis †

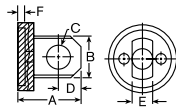

Cylinder Tons	Part No.	A (in.)	B (in.)	C (in.)	D (in.)	E (in.)	F (in.)
5	350096	2.06	1.13	0.63	0.63	0.56	0.25
10	350097	3.00	1.69	0.88	1.00	1.00	0.25
15	350098	3.06	1.69	0.88	1.00	1.00	0.25
25	420061	3.56	2.25	1.25	1.25	1.25	0.25

† Mounting screws are included.

Model Shown:
RA552, RA1006



Technical Dimensions

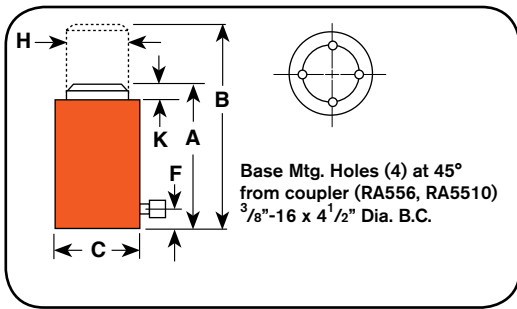

Ordering Information

Cyl. Cap.	Stroke	Order No.	Oil Cap.	A		C	F	H	K	Bore Dia.	Cylinder Effective Area	Int. Press. at Cap.	Tons at 10,000	Prod. Wt.
				Retracted Height	Extended Height									
(tons)	(in.)		(cu. in.)	(in.)	(in.)	(in.)	(in.)	(in.)	(in.)	(in.)	(sq. in.)	(psi)	(tons)	(lbs.)
20	2.13	RA202	9.41	6.38	8.50	3.75	1.25	2.00	0.31	2.38	4.43	9,030	22.15	7.70
	4.13	RA204	18.27	8.38	12.50	3.75	1.25	2.00	0.31	2.38	4.43	9,030	22.15	9.30
	6.13	RA206	27.13	10.38	16.50	3.75	1.25	2.00	0.31	2.38	4.43	9,030	22.15	11.30
30	2.13	RA302	13.79	7.38	9.50	4.25	1.25	2.50	0.38	2.88	6.49	9,250	32.45	11.10
	4.13	RA304	26.77	9.38	13.50	4.25	1.25	2.50	0.38	2.88	6.49	9,250	32.45	13.10
	6.13	RA306	39.75	11.38	17.50	4.25	1.25	2.50	0.38	2.88	6.49	9,250	32.45	15.10
55	2.13	RA552	23.50	6.75	8.88	5.25	1.38	3.13	0.25	3.75	11.04	9,960	55.20	16.20
	4.13	RA554	45.50	8.75	12.88	5.25	1.38	3.13	0.25	3.75	11.04	9,960	55.20	19.60
	6.13	RA556*	67.60	10.75	16.88	5.25	1.38	3.13	0.25	3.75	11.04	9,960	55.20	24.00
	10.00	RA5510*	110.40	15.13	25.13	5.25	1.38	3.13	0.25	3.75	11.04	9,960	55.20	31.80
100	2.13	RA1002	43.80	7.75	9.88	7.38	1.19	4.13	0.13	5.13	20.62	9,696	103.10	33.40
	6.25	RA1006*	129.00	11.75	18.00	7.38	1.19	4.13	0.13	5.13	20.62	9,696	103.10	49.90
	10.25	RA10010*	21.00	15.63	25.8	7.38	1.19	4.13	0.22	5.13	20.62	9,696	103.10	67.00

* Equipped with carrying handles.

Features

LIGHTWEIGHT DESIGN, EASY TO TRANSPORT AND POSITION.

- Hard coated aluminum piston rod and cylinder bore resist wear and corrosion.
- Grooved piston top helps keep the load from sliding on top of piston.
- Aluminum body resists sparking in explosive environments.
- Complies with ANSI / ASME B30.1 Safety Standards.



Optional Cylinders Bases

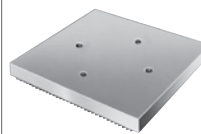

Aluminum Cylinder Base – For use when an enlarged cylinder base is needed or advantageous. Attaches to bottom of RA556, RA556L and RA5510 with four 3/8”-16 screws (included). Serrated base for extra stability.

Order No: 208406 – Aluminum cylinder base, 7” square. For use with RA556, RA556L and RA5510 cylinders.



Optional Cylinders Lifting Handles



Order Number: 420496BK2
Lifting handle for RA552, RA554 cylinders

Order Number: 420498BK2
Lifting handle for RA1002, RA10010 cylinders

Model Shown:
RLS100



RLS200 used in this lifting application.

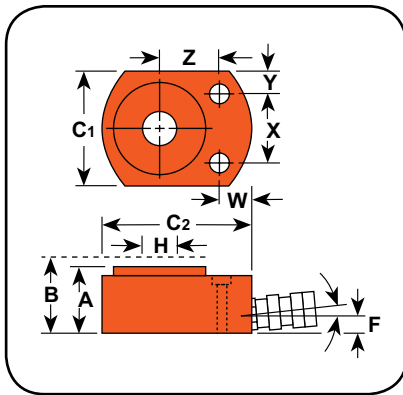
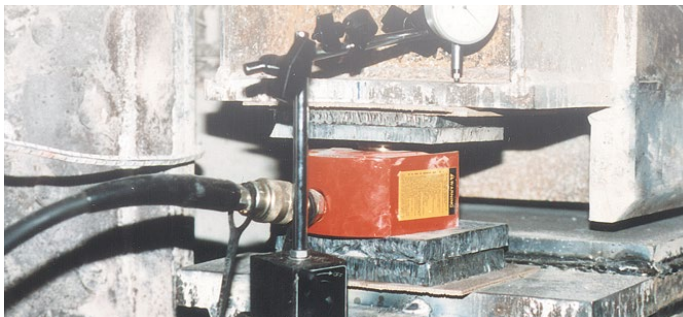

Features

IDEAL LOW CLEARANCE OR TIGHT CONSTRAINT APPLICATIONS REQUIRING HIGH FORCES.

- Low height starting at 1.63" to 4.00".
- Cylinder body, piston and gland nut are "Power-Tech" treated for corrosion and abrasion resistance.
- Standard domed piston rod (5-30 tons) or swivel cap (50-150 tons) minimize effects of off-center loading.
- Unique heavy-duty spring provides fast piston return on all cylinders, except RLS50.
- Coupler is angled upward for extra clearance.
- Complies with ANSI / ASME B30.1 Safety Standards.



RLS1000S (with swivel load cap)



RLS Series ending with an "S" suffix denotes models equipped with a swivel load cap.



Mounting holes for "RLS" cylinders

RLS Series	Description	RLS Series	Description
RLS50	0.34" C'bore x 0.25" deep, 0.22" thru hole	RLS500S	0.70" C'bore x 0.50" deep, 0.47" thru hole
RLS100	0.42" C'bore x 0.34" deep, 0.28" thru hole	RLS750S	0.80" C'bore x 0.56" deep, 0.53" thru hole
RLS200	0.62" C'bore x 0.41" deep, 0.41" thru hole	RLS1000S	0.80" C'bore x 0.56" deep, 0.53" thru hole
RLS300	0.62" C'bore x 0.44" deep, 0.28" thru hole	RLS1500S	0.81" C'bore x 0.56" deep, 0.53" thru hole

Ordering Information

Cyl. Cap. (tons)	Stroke (in.)	Order No.	Oil Cap. (cu. in.)	A	B	C1		C2	F	H	Mounting Hole Location				Bore Dia. (in.)	Cylinder Effective Area (sq. in.)	Int. Press. at Cap. (psi)	Tons at 10,000 (tons)	Prod. Wt. (lbs.)
				Retracted Height (in.)	Extended Height (in.)	Outside Dia. (in.)	(in.)	Base to Port (in.)	Piston Rod Dia. (in.)	(in.)	(in.)	(in.)	(in.)						
5	0.56	RLS50	0.62	1.63	2.19	1.63	2.56	0.75	0.63	0.75	1.13	0.25	1.00	1.13	0.994	10,061	4.97	2.20	
10	0.44	RLS100	1.00	1.75	2.19	2.19	3.25	0.63	0.75	0.69	1.44	0.38	1.31	1.69	2.236	8,943	11.18	3.30	
20	0.44	RLS200	2.00	2.00	2.44	3.00	4.00	0.66	1.13	0.72	1.94	0.53	1.56	2.38	4.430	9,029	22.15	5.60	
30	0.50	RLS300	3.20	2.31	2.81	3.75	4.50	0.72	1.38	0.81	2.06	0.84	1.75	2.88	6.492	9,242	32.46	8.60	
50	0.63	RLS500S	6.00	2.63	3.25	4.50	5.50	0.84	1.75	0.94	2.63	0.94	2.13	3.50	9.621	10,394	48.10	14.00	
75	0.63	RLS750S	9.90	3.13	3.75	5.53	6.50	1.00	2.13	0.94	3.00	1.27	2.59	4.50	15.904	9,431	79.52	23.30	
100	0.63	RLS1000S	12.30	3.38	4.00	6.00	7.00	1.00	2.50	0.81	3.00	1.50	2.81	5.00	19.635	10,186	98.17	30.00	
150	0.56	RLS1500S	17.20	4.00	4.56	7.50	8.50	1.31	3.00	1.31	4.63	1.44	3.13	6.25	30.680	9,778	153.39	52.00	

Model Shown:
RSS2503, RSS302



Technical Dimensions

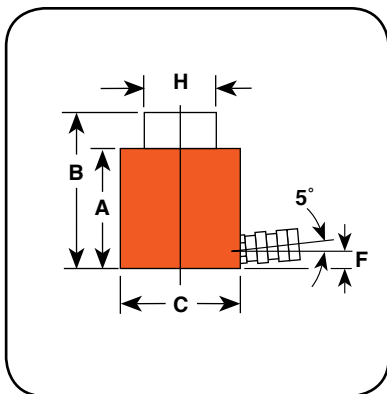

RSS302 is perfect for any bridge construction application.



Features

IDEAL FOR CONFINED AREAS WITH 3 1/2" TO 11 7/16" CLEARANCE.

- "Power-Tech" nitro-carburization surface treatment inhibits corrosion and provides exceptional durability for the rod and piston.
- Heavy-duty return spring (except for double-acting models) provides fast piston return & low collapsed height.
- Coupler on 10 - 50 ton models is angled upward 5° for added clearance.
- Grooved piston top keeps load from sliding.
- Cylinders can be "dead-ended" at full capacity.
- Removable carrying handles on 100 and 250 ton models.
- Complies with ANSI / ASME B30.1 Safety Standards.



Optional Swivel Load Caps Ordering Info

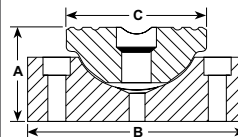

Reduce the effects of off-center loading. Tilts up to 5 degrees. Radial grooves on top of cap reduce load slippage. Notch across face of each cap helps keep loads having a protruding or round shaped centered.

Use with Cyl. No.	Swivel Cap Order No.	Wt. (lbs.)	A (in.)	B (in.)	C (in.)
RSS101	350320	0.5	1.00	1.44	1.44
RSS202	350321	1.3	1.38	2.13	2.13
RSS302	350322	1.6	1.38	2.50	2.13
RSS502	350331	2.7	1.44	3.25	2.13
RSS1002	350332	6.6	1.81	4.38	3.13



Cribbing Block Operation

Convert Power Team "Shorty" cylinders to mechanical cribbing devices. They are more stable and safe than timber or other awkward, makeshift methods. Ideal for lifting applications such as structure moving. Reduces cribbing time dramatically. In effect, increases the stroke of the cylinder as stacking pads act as cylinder extensions:

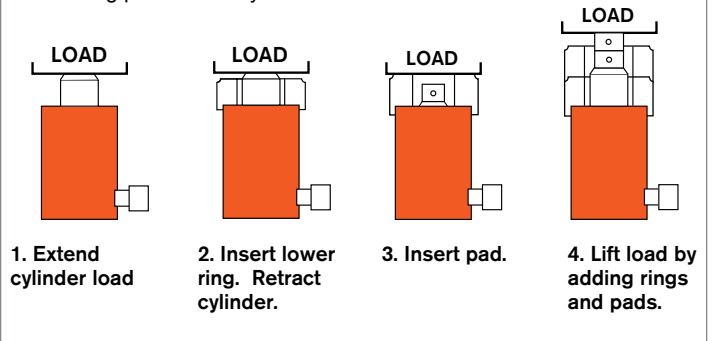

Ordering Information

Cyl. Cap. (tons)	Stroke (in.)	Order No.	Oil Cap. (cu. in.)		A	B	C	F	H	Bore Dia. (in.)	Cylinder Effective Area (sq. in.)	Int. Press. at Cap. (psi)	Tons at 10,000 (tons)	Prod. Wt. (lbs.)
					Retracted Height (in.)	Extended Height (in.)	Outside Dia. (in.)	Base to Port (in.)	Piston Rod Dia. (in.)					
			Push	Return										
10	1.50	RSS101	3.40	–	3.50	5.00	2.75	0.63	1.50	1.69	2.24	8,943	11.20	6.00
20	1.75	RSS202	7.70	–	3.75	5.50	3.56	0.63	2.16	2.38	4.43	9,029	22.10	9.90
30	2.44	RSS302	15.80	–	4.63	7.06	4.00	0.63	2.50	2.88	6.49	9,243	32.50	14.70
50	2.38	RSS502	22.80	–	5.00	7.38	4.88	0.75	3.13	3.50	9.62	10,393	48.10	23.20
100	2.25	RSS1002	44.20	–	5.50	7.75	6.63	0.94	4.38	5.00	19.63	10,186	98.20	47.30
100	1.50	RSS1002D*	29.40	12.90	5.69	7.19	6.88	0.94	3.75	5.00	19.63	10,186	98.20	54.60
250	3.00	RSS2503	150.60	–	11.44	14.44	9.88	1.81	5.50	8.00	50.22	9,956	251.10	220.00

* Note: RSS1002D is double-acting.

Optional Cylinders Cribbing Blocks

Cribbing blocks are shown on a 30 ton RSS302 "Shorty" cylinder. Each kit includes:

The Insertion tool (45589) is used for keeping hand from load.

Cribbing Block Ordering Information

For Use With	30 Ton Cylinder Number RSS302			50 Ton Cylinder Number RSS502			100 Ton Cylinder Number RSS1002		
Order No.	30 Ton Set Number CB30			50 Ton Set Number CB50			100 Ton Set Number CB100		
	Lower Ring	Upper Ring	Stacking Pad	Lower Ring	Upper Ring	Stacking Pad	Lower Ring	Upper Ring	Stacking Pad
Number included in set	1	2	3	1	2	3	1	3	4
Outside Diameter (in.)	4.50	4.50	2.75	5.50	5.50	3.38	7.39	7.39	4.75
Inside Diameter (in.)	2.81	2.81	–	3.45	3.45	–	4.81	4.81	–
Height, each (in.)	2.28	1.80	1.78	2.22	1.72	1.69	2.13	1.75	1.72
Total stacked height of Rings in Set (in.)	5.88			5.66			7.38		
Weight of Set (lbs.)	20			28			64		

Note: Each set includes one Insertion Handle 45589 - 0.5" Hex x 18" Long, 4" Bend

Model Shown:
RH203, RH503



Features

IDEAL FOR CABLE PULLING AND TENSIONING, ANCHOR BOLTS, FORCING SCREWS, ETC.

- Cylinder body, piston and gland nut "Power-Tech" treated for corrosion and abrasion resistance.
- Most models feature threaded collar, excludes the RH203 and RHA306 models.
- All cylinders are furnished with a 9796 3/8" NPT female half coupler, except the RH120.
- Aluminum cylinder body and piston are featured on the RHA306 cylinder.
- Complies with ANSI / ASME B30.1 Safety Standards.

Technical Dimensions

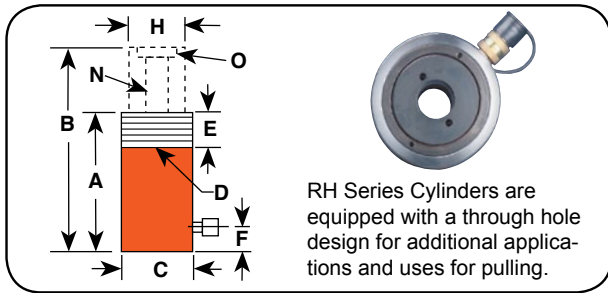

Ordering Information

Cyl. Cap. (tons)	Stroke (in.)	Order No.	Oil Cap. (cu. in.)	A	B	C	D	E	F	H	N	O	Mounting Holes and Bolt Circle (in.)	Cylinder Effective Area (sq. in.)	Int. Press. at Cap. (psi)	Tons at 10,000 (tons)	Prod. Wt. (lbs.)
				Re-tracted Height (in.)	Ex-tended Height (in.)	Outside Dia. (in.)	Collar Thread (in.)	Collar Thread Length (in.)	Base to Port (in.)	Piston Rod Dia. (in.)	Center Hole Dia. (in.)	Insert Thread Size (in.)					
10	2.50	RH102	5.52	5.31	7.81	3.00	-	-	1.00	2.06	0.77	1 3/4 - 12	1/4-20 x 2 3/8	2.21	9,054	11.00	9.00
	8.00	RH108	17.68	11.31	19.31	3.00	-	-	1.00	2.06	0.77	1 3/4 - 12	1/4-20 x 2 3/8	2.21	9,054	11.00	18.70
12	0.31	RH120**	0.87	2.19	2.50	2.75	2 3/4 - 16	1.25	0.38	1.38	0.80	3/4 - 16	5/16-18 x 2	2.76	8,692	13.80	3.00
	1.63	RH121	4.49	4.81	6.44	2.75	2 3/4 - 16	1.25	1.00	1.38	0.80	-	-	2.76	8,692	13.80	6.60
	1.63	RH121T*	4.49	4.81	6.44	2.75	2 3/4 - 16	1.25	1.00	1.38	0.81	3/4 - 16	-	2.76	8,692	13.80	6.60
	3.00	RH123	8.29	7.25	10.25	2.75	2 3/4 - 16	0.81	1.00	1.38	0.81	-	-	2.76	8,692	13.80	8.90
20	2.00	RH202	9.45	6.13	8.13	3.88	3 7/8 - 12	1.50	1.00	2.13	1.08	1 9/16 - 16	3/8-16 x 3 1/4	4.72	8,466	23.60	16.10
	3.00	RH203	11.76	6.06	9.06	4.00	-	-	1.00	2.75	1.05	2 1/4 - 12	3/8-16 x 3 1/4	3.92	10,186	19.60	20.00
	6.00	RH206	28.35	12.13	18.13	3.88	3 7/8 - 12	1.50	1.00	2.13	1.08	1 9/16 - 16	3/8-16 x 3 1/4	4.72	8,466	23.60	30.20
30	2.50	RH302	15.85	6.25	8.75	4.75	4 3/4 - 12	1.50	1.16	3.25	1.30	2 3/4 - 12	7/16-20 x 3 5/8	6.34	9,457	31.70	25.60
	5.88	RHA306	38.10	11.16	17.03	5.13	-	-	1.25	3.25	1.28	2 5/8 - 8	-	6.34	9,457	31.70	21.90
	6.00	RH306	38.10	9.75	15.75	4.75	4 3/4 - 12	1.50	1.16	3.25	1.28	2 3/4 - 12	7/16-20 x 3 5/8	6.34	9,457	31.70	39.00
50	3.00	RH503	32.58	7.13	10.13	6.00	6 - 12	2.00	1.25	4.13	1.67	3 1/4 - 12	5/8-18 x 4 3/4	10.86	9,208	54.30	46.60
60	3.00	RH603*	37.00	9.25	12.25	6.25	6 1/4 - 12	2.50	1.00	3.59	2.13	3 - 12	1/2-13 x 5 1/8	12.31	9,750	61.60	60.00
60	6.00	RH606*	73.86	12.25	18.25	6.25	6 1/4 - 12	2.50	1.00	3.59	2.13	3 - 12	1/2-13 x 5 1/8	12.31	9,750	61.60	78.00
100	3.00	RH1003*	61.80	10.00	13.00	8.38	-	-	1.25	5.00	3.13	4 1/8 - 12	-	20.62	9,700	103.10	115.00

* Supplied with carrying handles.

Aluminum

** RH120 and RH121T do not have an internal threaded insert, but do have a 3/4-16 internal thread. The RH120 inlet port is 1/4" NPTF.



Optional Piston Head Inserts



For Use With:	Threaded Insert	Order No.
RH102, RH108	3/4"-16	28632
RH203	1"-8	28612
RH302, RH306	1 1/4"-7	38904
RH303	1 1/4"-7	28644
RH503	1 5/8"-5 1/2	38855
RH603, RH605	1 5/8"-5 1/2	34251



Optional Cylinders Lifting Handles



Order Number: 252215

Lifting handle for RH303, RH306, AND RH306D, AND RHA306

Model Shown:
RH605



Technical Dimensions

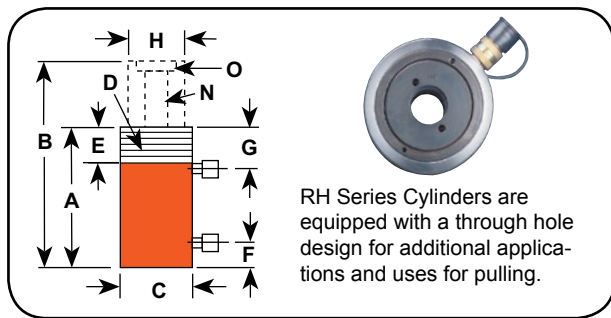

Ordering Information

Cyl. Cap.	Stroke		Order No.	Oil Cap.		A	B	C	D	E	F	G	H	N	O	Mounting Holes and Bolt Circle	Cylinder Effective Area		Int. Press. at Cap.		Tons at 10,000		Prod. Wt.
	(tons)	(in.)		(cu. in.)		Retract-ed Height	Ex-tended Height	Outside Dia.	Collar Thread	Collar Thread Length	Base to Port	Cyl. Top to Port	Piston Rod Dia.	Center Hole Dia.	Insert Thread Size		(sq. in.)	(psi)	(tons)		(lbs.)		
	Push	Pull		Push	Pull	(in.)	(in.)	(in.)	(in.)	(in.)	(in.)	(in.)	(in.)	(in.)	(in.)		(in.)	Push	Pull	Push	Pull	Push	
30	15	3.00	RH303	17.60	10.20	7.06	10.06	4.75	-	-	1.00	1.63	2.50	1.28	2 - 12	3/8-16 x 3 5/8	5.89	3.38	10,200	8,876	29.50	16.90	29.80
30	15	6.00	RH306D	35.34	20.28	11.06	17.06	4.75	-	-	1.00	1.63	2.50	1.27	2 - 12	7/16-20 x 3 5/8	5.89	3.38	10,200	8,876	29.50	16.90	45.00
30	20	10.13	RH3010	66.00	41.00	17.25	27.38	4.50	4 1/2 -12	1.63	1.75	3.19	2.38	1.31	1 7/8 - 16	-	6.54	4.04	9,174	9,901	32.70	20.20	61.00
60	25	4.00	RHA604D	49.20	20.60	9.50	13.50	7.00	-	-	1.56	2.25	4.00	2.13	3 - 12	1/2-13 x 5 1/8	12.31	5.15	9,750	9,709	61.50	27.70	35.60
60	25	5.00	RH605*	61.55	25.77	9.50	14.50	6.53	-	-	1.00	1.75	4.00	2.13	3 - 12	1/2-13 x 5 1/8	12.31	5.15	9,750	9,709	61.50	27.70	73.00
60	40	10.13	RH6010*	133.00	87.00	18.06	28.19	6.25	6 1/4 -12	1.88	2.13	3.22	3.63	2.13	3 - 16	-	13.14	8.59	9,132	9,313	65.70	42.90	120.00
100	45	1.50	RH1001	32.10	14.20	6.50	8.00	8.38	-	-	1.25	2.31	5.00	3.14	4 - 16	5/8-11 x 7	21.39	9.43	9,350	9,544	106.90	47.10	85.00
100	50	6.00	RH1006*	120.20	65.60	12.38	18.38	7.25	-	-	1.47	2.33	4.38	2.06	-	1/2-13 x 5 1/2	20.03	10.93	9,986	9,150	100.10	54.70	95.00
100	45	10.13	RH10010*	216.60	95.50	19.50	29.63	8.50	8 1/2 -12	2.25	2.50	3.61	5.50	3.14	4 1/2 - 12	-	21.39	9.43	9,350	9,544	106.90	47.10	240.00
150	70	5.00	RH1505*	150.90	73.60	12.25 †	17.25	8.50	-	-	1.47	2.69	5.50	2.56	-	-	30.10	14.70	9,937	9,524	150.90	73.60	148.00
150	75	8.00	RH1508*	239.60	127.20	13.75	21.75	9.75	-	-	1.55	2.41	6.00	3.16	5 - 12	-	29.95	15.90	10,015	9,434	149.80	79.50	227.00
200	75	8.00	RH2008*	323.60	127.60	16.06	24.06	10.75	-	-	2.25	3.22	7.50	4.06	6 - 12	1 1/4-7 x 7 3/4	40.45	15.95	9,888	9,404	202.30	79.80	311.00

* Supplied with carrying handles.

† Measured with serrated load cap installed.

Aluminum

Features

FOR PULLING AND TENSIONING OF CABLES, ANCHOR BOLTS, AND FORCING SCREWS.

- Plated piston rod resists wear and superior packings provide high cycle life without leakage.
- Built-in safety feature prevents over-pressurization of the retraction circuit.
- Corrosion-resistant standpipe has "Power-Tech" treatment.
- 30, 60, 100 Ton Double-Acting Models Feature Threaded Collar.
- Aluminum cylinder body and piston are featured on the RHA604D cylinder.
- Each cylinder has 9796 3/8" NPTF female half couplers. The 60 ton through 200 ton steel models are equipped with removable carrying handles.

Optional Piston Head Inserts



For Use With:	Threaded Insert	Order No.
RH102, RH108	3/4"-16	28632
RH203	1"-8	28612
RH302, RH306	1 1/4"-7	38904
RH303	1 1/4"-7	28644
RH503	1 5/8"-5 1/2	38855
RH603, RH605	1 5/8"-5 1/2	34251

Optional Cylinders Lifting Handles



Order Number: 4213120R9
Lifting handle for RH303 and RH306D

Model Shown:
RT302, RT1004



Features

IDEAL FOR PULLING AND PRESSING APPLICATION, REQUIRING HIGHER FORCES.

- Cylinders withstand full “dead-end” loads.
- Compact design is ideal for applications in which space is limited.
- Basic head can be changed from a tapped hole to plain hole by simply changing the insert.
- Pistons have “Power-Tech” treatment for corrosion and abrasion resistance.
- Complies with ANSI / ASME B30.1 Safety Standards.



Center Hole Design Cylinders

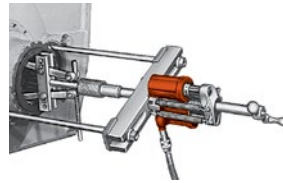

RT Series pullers are equipped with a through hole design for additional applications and uses for pulling requiring high force.



Optional Plain Head Cylinder Inserts



Switch from a tapped hole to a plain hole quickly with these cylinder head inserts. They are held in place with a socket screw. Plain hole permits use of a speed nut for re-adjusting cylinder after extension.

For Use With:	Threaded Order No.	Plain Order No.
RT172	21669	21714
RT302	21873	21872
RT503	22274	22275
RT1004	24197	24196



Learn More - About Hydraulic Safety Insight



Looking for great safety suggestions? Visit our Resource Section to get a better understanding of hydraulic and mechanical safety insights on what to look for when working around hydraulics.

▶ **RT Series center hole cylinder is versatile for strand or pull applications**

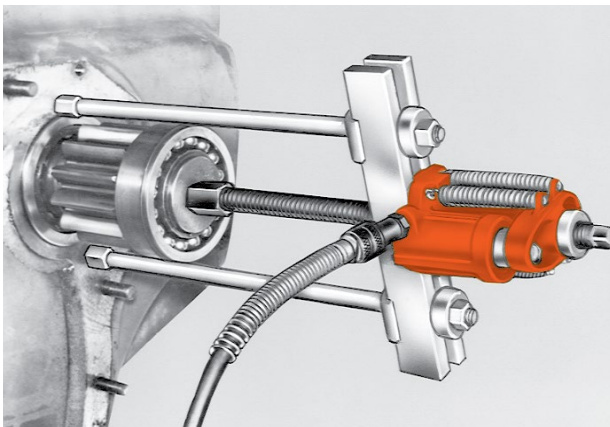

Technical Dimensions, Base Mounting Holes

Dimensions for reference only.

Single-Acting, Spring Return Cylinders

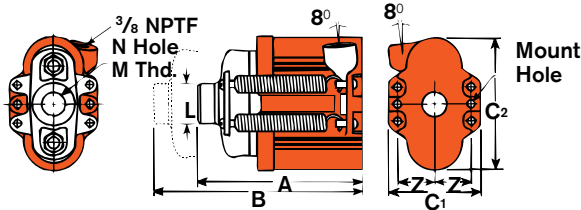

Double-Acting Cylinder (RT1004)

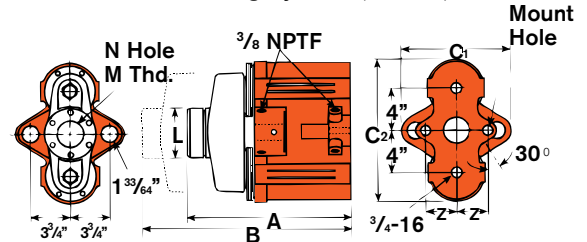

Ordering Information

Cyl. Cap. (tons)	Stroke (in.)	Order No.	Oil Cap.		A Retract- ed Height (in.)	B Extend- ed Height (in.)	C1 C2 Outside Dia. (in.) (in.)		L Load Cap Dia. (in.)	M Load Cap Thread (in.)	N Center Hole Dia. (in.)	Z Mount Hole Location (in.)	Mount Hole (in.)	Cylinder Effective Area (sq. in.)	Int. Press. at Cap. (psi)	Tons at 10,000 (tons)	Prod. Wt. (lbs.)
			Push	Return													
			(cu. in.)		(in.)	(in.)	(in.)	(in.)	(in.)	(in.)	(in.)	(in.)	(in.)	(in.)	(in.)	(sq. in.)	(psi)
17.5	2.00	RT172	7.06	—	6.88	8.88	3.75	5.75	1.75	1" - 8	1.03	1.50	11/32	3.53	9,915	17.70	14.60
30	2.50	RT302	15.70	—	8.44	10.94	4.25	7.50	2.25	1 1/4" - 7	1.30	1.81	15/32	6.28	9,554	31.40	28.20
50	3.00	RT503	29.40	—	10.56	13.56	5.88	9.38	2.88	1 5/8" - 5 1/2	1.67	2.38	21/32	9.81	10,193	49.10	56.00
100	4.88	RT1004*	96.50	63.20	15.13	20.00	10.50	12.25	4.75	2 1/2" - 8	2.56	2.88	25/32	19.24	10,395	96.20	160.00

* The RT1004 has a bypass when full stroke is reached, preventing over-pressurization of the cylinder.

NOTE: Each cylinder complete with threaded cylinder head insert, cylinder half coupler and cylinder attaching screws.

Accessories Ordering Information

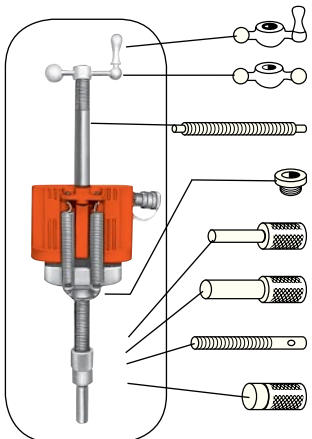

Use with Cylinder Number	Number	RT172, RH203	RT302, RH302, RH303, RH306	RT503, RH503, RH603, RH605, RH606	RT1004
Order Set		RHA20	RHA30	RHA50	RHA100
Speed Crank	1	24814	27198	29595	303785
Speed Nut	2	302482 1"-8 thread	302483 1 1/4"-7 thread	33439 1 5/8"-5 1/2 thread	34136 2 1/2"-8 thread
Adjusting Screw	3	32118 1"-8 thd. 20" lg.	34758 1 1/4"-7 thd. 24" lg.	32698 1 5/8"-5 1/2 thd. 30" lg.	32699 2 1/2"-8 thd 34.25" lg.
Threaded Insert	4	Threaded insert supplied with RT series cylinders. Order threaded insert for RH series cylinders with the accessory set.			
Pushing Adapter	5	201923 1"-8 thread 0.5" diameter shank	34510 1 1/4"-7 thread 0.75" diameter shank	34755 1 5/8"-5 1/2 thread 1" diameter shank	—
Pushing Adapter	6	201454 1"-8 thread 0.75" diameter shank	34511 1 1/4"-7 thread 1" diameter. shank	34756 1 5/8"-5 1/2 thread 1.25" diameter shank	—
Jack Screw	7	24813 1"-8 thd. 7" lg.	25931 1 1/4"-7 thd. 9" lg.	32701 1 5/8"-5 1/2 thd. 11" lg.	32702 2 1/2"-8 thd. 16" lg.
Screw Cap	8	28228 1"-8 thd. 1.5" dia.	28229 1 1/4"-7 thd 1.75" dia.	28230 1 5/8"-5 1/2 thd, 2.25" dia.	—

Model Shown:
RGG Family



Features

HEAVY LIFT, GENERAL PURPOSE CYLINDER FOR MAINTENANCE APPLICATIONS.

- Single-Acting, load return hydraulic cylinders, tonnages ranging from 55 - 200.
- Patented swivel cap provides concentrated load centering up to 5 degrees.
- Sealing technology provides rod lubrication to reduce friction and wear.
- Floating piston design resists side loading conditions.
- “Power-Tech” nitro-carburization surface treatment inhibits corrosion and provides exceptional durability
- Base mounting holes standard on all models (they are not maintained to port location).
- One high flow 3/8” NPTF female half coupler and removable carry strap w/ eyelets are included.
- Complies with ANSI / ASME B30.1 Safety Standards.



RGG Series Design Features

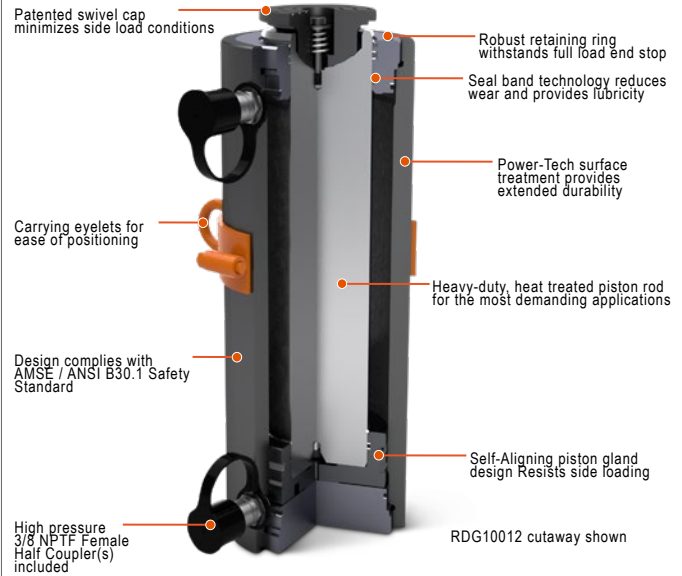

Technical Dimensions, Base Mounting Holes

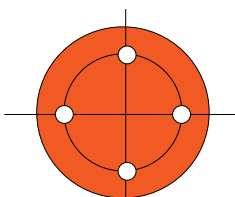

Four base mounting holes are 45° apart - standard on all models.

Tonnage	55	75	100	150	200
# of Base Mounting Holes	4	4	4	4	4
Base thread size	M12X1.75 - 6H	M12X1.75 - 6H	M16X1.5 - 6H	M16X1.5 - 6H	M20X1.5 - 6H
Base thread depth (in)	0.709	0.709	0.62	0.9	1.2
Base Mounting Diameter (in.)	3.03	3.66	4.00	5.12	5.72
Orientation	Mounting hole orientation is not maintained to port location.				



Cylinder Selection



Power Team recommends using 80% of the rated capacity and stroke to maximize product performance and safety.

Custom stroke lengths are available, contact your local Power Team Sales Office for details and availability.

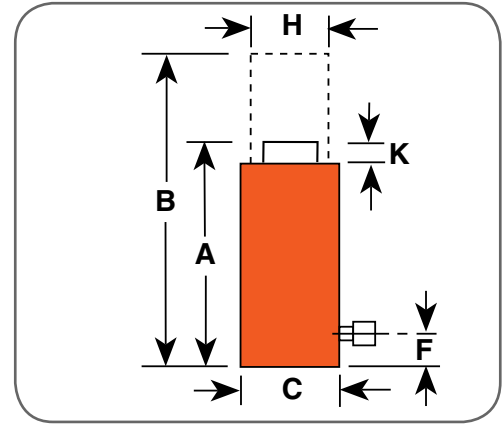

Ordering Information

Cyl. Cap.	Stroke	Order No.	A	B	C	F	H	K	Swivel Cap Dia.	Bore Dia.	Cyl. Eff. Area (Advance)	Oil Cap.	Int. Press. at Cap.	Tons at 10,000 PSI	Prod. Wt.
			Ret. Height	Ext. Height	Out. Dia.	Base to Port	Piston Rod Dia.	Swivel Cap Protrusion							
(tons)	(in.)		(in.)	(in.)	(in.)	(in.)	(in.)	(in.)	(in.)	(in.)	(sq. in.)	(cu. in.)	(psi)	(tons)	(lbs.)
55	2	RG552	7.84	9.84	5.16	1.61	2.75	0.67	2.78	3.75	11.04	22.09	9959	55.22	38.90
	4	RG554	9.84	13.84	5.16	1.61	2.75	0.67	2.78	3.75	11.04	44.18	9959	55.22	47.80
	6	RG556	11.84	17.84	5.16	1.61	2.75	0.67	2.78	3.75	11.04	66.27	9959	55.22	59.70
	8	RG558	13.84	21.84	5.16	1.61	2.75	0.67	2.78	3.75	11.04	88.36	9959	55.22	68.70
	10	RG5510	15.84	25.84	5.16	1.61	2.75	0.67	2.78	3.75	11.04	110.45	9959	55.22	77.70
	12	RG5512	17.84	29.84	5.16	1.61	2.75	0.67	2.78	3.75	11.04	132.54	9959	55.22	86.60
	13	RG5513	18.84	31.84	5.16	1.61	2.75	0.67	2.78	3.75	11.04	143.58	9959	55.22	91.10
75	14	RG5514	19.84	33.84	5.16	1.61	2.75	0.67	2.78	3.75	11.04	154.63	9959	55.22	95.60
	2	RG752	8.31	10.31	5.78	1.76	3.12	0.76	3.24	4.38	15.03	30.06	9979	75.16	51.60
	4	RG754	10.31	14.31	5.78	1.76	3.12	0.76	3.24	4.38	15.03	60.13	9979	75.16	67.10
	6	RG756	12.31	18.31	5.78	1.76	3.12	0.76	3.24	4.38	15.03	90.19	9979	75.16	77.80
	8	RG758	14.31	22.31	5.78	1.76	3.12	0.76	3.24	4.38	15.03	120.26	9979	75.16	88.50
	10	RG7510	16.31	26.31	5.78	1.76	3.12	0.76	3.24	4.38	15.03	150.32	9979	75.16	99.30
	12	RG7512	18.31	30.31	5.78	1.76	3.12	0.76	3.24	4.38	15.03	180.39	9979	75.16	110.00
100	13	RG7513	19.31	32.31	5.78	1.76	3.12	0.76	3.24	4.38	15.03	195.42	9979	75.16	115.30
	14	RG7514	20.31	34.31	5.78	1.76	3.12	0.76	3.24	4.38	15.03	210.45	9979	75.16	120.70
	2	RG1002	8.70	10.70	6.53	1.85	3.75	0.92	3.87	5.13	20.63	41.27	9692	103.17	70.90
	4	RG1004	10.70	14.70	6.53	1.85	3.75	0.92	3.87	5.13	20.63	82.54	9692	103.17	84.50
	6	RG1006	12.70	18.70	6.53	1.85	3.75	0.92	3.87	5.13	20.63	123.81	9692	103.17	98.00
	8	RG1008	14.70	22.70	6.53	1.85	3.75	0.92	3.87	5.13	20.63	165.08	9692	103.17	111.50
	10	RG10010	16.70	26.70	6.53	1.85	3.75	0.92	3.87	5.13	20.63	206.35	9692	103.17	125.00
150	12	RG10012	18.70	30.70	6.53	1.85	3.75	0.92	3.87	5.13	20.63	247.62	9692	103.17	138.50
	13	RG10013	19.70	32.70	6.53	1.85	3.75	0.92	3.87	5.13	20.63	268.25	9692	103.17	145.30
	14	RG10014	20.70	34.70	6.53	1.85	3.75	0.92	3.87	5.13	20.63	288.88	9692	103.17	152.10
	2	RG1502	9.37	11.37	7.70	2.11	4.50	0.95	4.63	6.25	30.68	61.37	9777	153.42	102.90
	4	RG1504	11.37	15.37	7.70	2.11	4.50	0.95	4.63	6.25	30.68	122.73	9777	153.42	120.90
	6	RG1506	13.37	19.37	7.70	2.11	4.50	0.95	4.63	6.25	30.68	184.10	9777	153.42	138.90
	8	RG1508	15.37	23.37	7.70	2.11	4.50	0.95	4.63	6.25	30.68	245.47	9777	153.42	156.90
200	10	RG15010	17.37	27.37	7.70	2.11	4.50	0.95	4.63	6.25	30.68	306.84	9777	153.42	174.90
	12	RG15012	19.37	31.37	7.70	2.11	4.50	0.95	4.63	6.25	30.68	368.20	9777	153.42	192.90
	13	RG15013	20.37	33.37	7.70	2.11	4.50	0.95	4.63	6.25	30.68	398.89	9777	153.42	201.90
	14	RG15014	21.37	35.37	7.70	2.11	4.50	0.95	4.63	6.25	30.68	429.57	9777	153.42	210.90
	2	RG2002	10.04	12.04	8.93	2.25	5.25	1.06	5.37	7.25	41.28	82.57	9689	206.42	148.50
	4	RG2004	12.04	16.04	8.93	2.25	5.25	1.06	5.37	7.25	41.28	165.14	9689	206.42	172.90
	6	RG2006	14.04	20.04	8.93	2.25	5.25	1.06	5.37	7.25	41.28	247.71	9689	206.42	197.20
200	8	RG2008	16.04	24.04	8.93	2.25	5.25	1.06	5.37	7.25	41.28	330.27	9689	206.42	221.60
	10	RG20010	18.04	28.04	8.93	2.25	5.25	1.06	5.37	7.25	41.28	412.84	9689	206.42	246.00
	12	RG20012	20.04	32.04	8.93	2.25	5.25	1.06	5.37	7.25	41.28	495.41	9689	206.42	270.30
	13	RG20013	21.04	34.04	8.93	2.25	5.25	1.06	5.37	7.25	41.28	536.70	9689	206.42	282.50
	14	RG20014	22.04	36.04	8.93	2.25	5.25	1.06	5.37	7.25	41.28	577.98	9689	206.42	294.70

Model Shown:
RGG Family



Features

HEAVY LIFT, GENERAL PURPOSE CYLINDER FOR TOUGH MAINTENANCE APPLICATIONS.

- Single-Acting, load return hydraulic cylinders, tonnages ranging from 250 - 600.
- Patented swivel cap provides concentrated load centering up to 5 degrees
- Sealing technology provides lubrication to reduce friction and wear.
- Floating piston design resists side loading conditions.
- "Power-Tech" nitro-carburization surface treatment inhibits corrosion and provides exceptional durability.
- Base mounting holes standard on all models (they are not maintained to port location).
- One high flow 3/8" NPTF female half coupler and removable carry strap w/ eyelets are included.
- Complies with ANSI / ASME B30.1 Safety Standards.



RGG Series Design Features

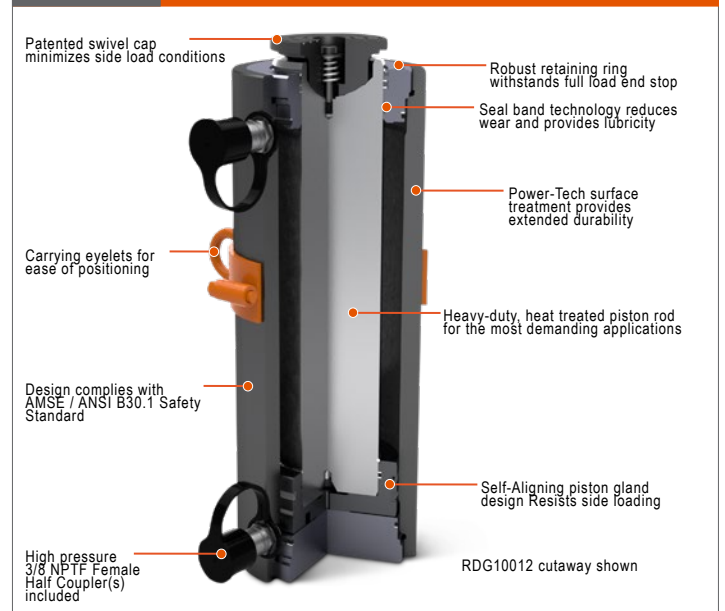

Technical Dimensions, Base Mounting Holes

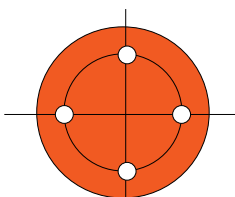

Four base mounting holes are 45° apart - standard on all models.

Tonnage	250	300	400	500	600
# of Base Mounting Holes	4	4	4	4	4
Base thread size	M24X3.0 - 6H	M24X3.0 - 6H	M30X3.5 - 6H	M30X3.5 - 6H	M33X2.0 - 6H
Base thread depth (in.)	1.457	1.457	1.8	1.5	1.95
Base Mounting Diameter (in.)	6.06	7.06	7.65	8.95	9.65
Orientation	Mounting hole orientation is not maintained to port location.				



Cylinder Selection



Power Team recommends using 80% of the rated capacity and stroke to maximize product performance and safety.

Custom stroke lengths are available, contact your local Power Team Sales Office for details and availability.

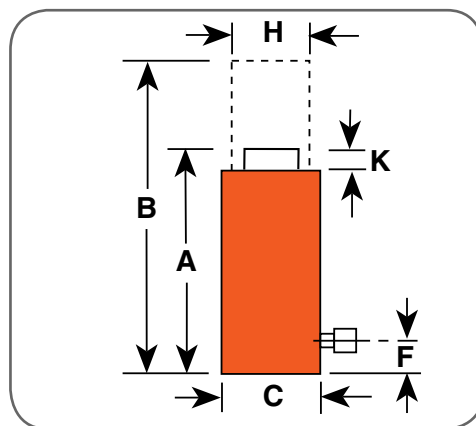

Ordering Information

Cyl. Cap.	Stroke	Order No.	A	B	C	F	H	K	Swivel Cap Dia.	Bore Dia.	Cyl. Eff. Area (Advance)	Oil Cap.	Int. Press. at Cap.	Tons at 10,000 PSI	Prod. Wt.
			Ret. Height	Ext. Height	Out. Dia.	Base to Port	Piston Rod Dia.	Swivel Cap Protrusion							
(tons)	(in.)		(in.)	(in.)	(in.)	(in.)	(in.)	(in.)	(in.)	(in.)	(sq. in.)	(cu. in.)	(psi)	(tons)	(lbs.)
250	2	RGG2502	10.30	12.30	9.85	2.35	6.00	1.12	5.56	8.00	50.27	100.53	9947	251.33	192.10
	4	RGG2504	12.30	16.30	9.85	2.35	6.00	1.12	5.56	8.00	50.27	201.06	9947	251.33	222.90
	6	RGG2506	14.30	20.30	9.85	2.35	6.00	1.12	5.56	8.00	50.27	301.59	9947	251.33	253.60
	8	RGG2508	16.30	24.30	9.85	2.35	6.00	1.12	5.56	8.00	50.27	402.12	9947	251.33	284.30
	10	RGG25010	18.30	28.30	9.85	2.35	6.00	1.12	5.56	8.00	50.27	502.65	9947	251.33	315.00
	12	RGG25012	20.30	32.30	9.85	2.35	6.00	1.12	5.56	8.00	50.27	603.18	9947	251.33	345.70
	13	RGG25013	21.30	34.30	9.85	2.35	6.00	1.12	5.56	8.00	50.27	653.45	9947	251.33	361.10
300	14	RGG25014	22.30	36.30	9.85	2.35	6.00	1.12	5.56	8.00	50.27	703.71	9947	251.33	376.50
	2	RGG3002	10.74	12.74	11.08	2.48	6.50	1.28	6.66	9.00	63.61	127.23	9432	318.07	251.20
	4	RGG3004	12.74	16.74	11.08	2.48	6.50	1.28	6.66	9.00	63.61	254.45	9432	318.07	288.60
	6	RGG3006	14.74	20.74	11.08	2.48	6.50	1.28	6.66	9.00	63.61	381.68	9432	318.07	326.00
	8	RGG3008	16.74	24.74	11.08	2.48	6.50	1.28	6.66	9.00	63.61	508.91	9432	318.07	362.40
	10	RGG30010	18.74	28.74	11.08	2.48	6.50	1.28	6.66	9.00	63.61	636.13	9432	318.07	400.80
	12	RGG30012	20.74	32.74	11.08	2.48	6.50	1.28	6.66	9.00	63.61	763.36	9432	318.07	438.20
400	13	RGG30013	21.74	34.74	11.08	2.48	6.50	1.28	6.66	9.00	63.61	826.97	9432	318.07	456.90
	14	RGG30014	22.74	36.74	11.08	2.48	6.50	1.28	6.66	9.00	63.61	890.59	9432	318.07	475.60
	2	RGG4002	12.07	14.07	12.93	2.77	7.50	1.46	7.77	10.50	86.58	173.16	9240	432.90	390.40
	4	RGG4004	14.07	18.07	12.93	2.77	7.50	1.46	7.77	10.50	86.58	346.32	9240	432.90	440.80
	6	RGG4006	16.07	22.07	12.93	2.77	7.50	1.46	7.77	10.50	86.58	519.48	9240	432.90	491.20
	8	RGG4008	18.07	26.07	12.93	2.77	7.50	1.46	7.77	10.50	86.58	692.63	9240	432.90	541.50
	10	RGG40010	20.07	30.07	12.93	2.77	7.50	1.46	7.77	10.50	86.58	865.79	9240	432.90	591.90
500	12	RGG40012	22.07	34.07	12.93	2.77	7.50	1.46	7.77	10.50	86.58	1038.95	9240	432.90	642.30
	13	RGG40013	23.07	36.07	12.93	2.77	7.50	1.46	7.77	10.50	86.58	1125.53	9240	432.90	667.50
	14	RGG40014	24.07	38.07	12.93	2.77	7.50	1.46	7.77	10.50	86.58	1212.11	9240	432.90	692.70
	2	RGG5002	12.28	14.28	14.16	2.90	8.00	1.55	8.51	11.50	103.85	207.70	9629	519.26	451.60
	4	RGG5004	14.28	18.28	14.16	2.90	8.00	1.55	8.51	11.50	103.85	415.41	9629	519.26	530.00
	6	RGG5006	16.28	22.28	14.16	2.90	8.00	1.55	8.51	11.50	103.85	623.11	9629	519.26	589.00
	8	RGG5008	18.28	26.28	14.16	2.90	8.00	1.55	8.51	11.50	103.85	830.82	9629	519.26	647.70
600	10	RGG50010	20.28	30.28	14.16	2.90	8.00	1.55	8.51	11.50	103.85	1038.52	9629	519.26	706.60
	12	RGG50012	22.28	34.28	14.16	2.90	8.00	1.55	8.51	11.50	103.85	1246.23	9629	519.26	765.50
	13	RGG50013	23.28	36.28	14.16	2.90	8.00	1.55	8.51	11.50	103.85	1350.08	9629	519.26	794.90
	14	RGG50014	24.28	38.28	14.16	2.90	8.00	1.55	8.51	11.50	103.85	1453.93	9629	519.26	824.40
	2	RGG6002	12.76	14.76	15.40	3.02	9.00	1.63	9.25	12.50	122.70	245.39	9780	613.48	561.70
	4	RGG6004	14.76	18.76	15.40	3.02	9.00	1.63	9.25	12.50	122.70	490.78	9780	613.48	633.80
	6	RGG6006	16.76	22.76	15.40	3.02	9.00	1.63	9.25	12.50	122.70	736.17	9780	613.48	705.90
600	8	RGG6008	18.76	26.76	15.40	3.02	9.00	1.63	9.25	12.50	122.70	981.56	9780	613.48	778.00
	10	RGG60010	20.76	30.76	15.40	3.02	9.00	1.63	9.25	12.50	122.70	1226.96	9780	613.48	850.10
	12	RGG60012	22.76	34.76	15.40	3.02	9.00	1.63	9.25	12.50	122.70	1472.35	9780	613.48	922.20
	13	RGG60013	23.76	36.76	15.40	3.02	9.00	1.63	9.25	12.50	122.70	1595.04	9780	613.48	958.20
	14	RGG60014	24.76	38.76	15.40	3.02	9.00	1.63	9.25	12.50	122.70	1717.74	9780	613.48	994.30

Model Shown:
RDG Family



▶ RDG Series is perfect choice for any heavy lift MRO application.



Features

HEAVY LIFT, GENERAL PURPOSE CYLINDER FOR TOUGH MRO APPLICATIONS.

- Double-Acting, hydraulic return cylinders, tonnages ranging from 55-200.
- Patented swivel cap provides concentrated load centering up to 5 degrees.
- Safety relief valve prevents over-pressurization of the retract circuit.
- Sealing technology provides lubrication to reduce friction and wear.
- "Power-Tech" nitro-carburization surface treatment inhibits corrosion and provides exceptional durability.
- Floating piston design resists side loading conditions.
- Base mounting holes standard on all models (they are not maintained to port location).
- Two high flow 3/8" NPTF female half coupler and removable carry strap w/ eyelets are included.
- Complies with ANSI / ASME B30.1 Safety Standards.



RDG Series Design Features

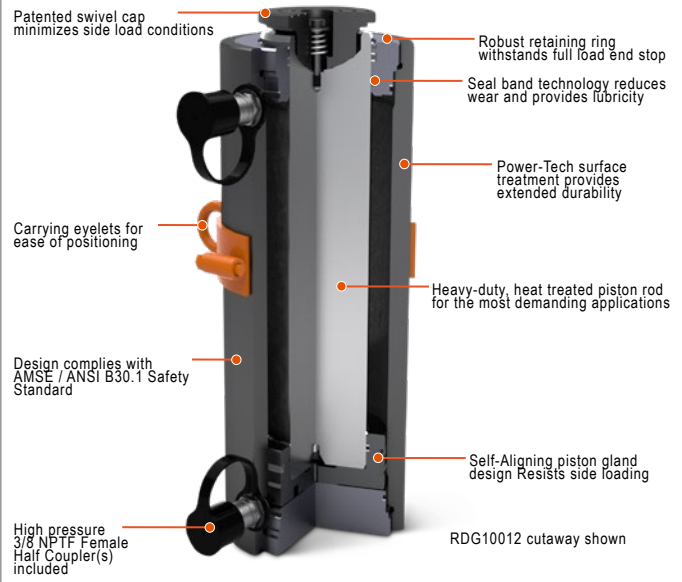

▶ **Technical Dimensions, Base Mounting Holes**

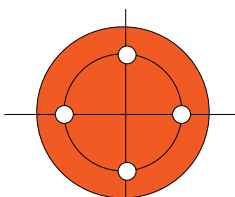

Four base mounting holes are 45° apart - standard on all models.

Tonnage	55	75	100	150	200
# of Base Mounting Holes	4	4	4	4	4
Base thread size	M12X1.75 - 6H	M12X1.75 - 6H	M16X1.5 - 6H	M16X1.5 - 6H	M20X1.5 - 6H
Base thread depth (in)	0.71	0.71	0.62	0.90	1.20
Base Mounting Diameter (in.)	3.03	3.66	4.00	5.12	5.72
Orientation	Mounting hole orientation is not maintained to port location.				



Cylinder Selection



Power Team recommends using 80% of the rated capacity and stroke to maximize product performance and safety.

Custom stroke lengths are available, contact your local Power Team Sales Office for details and availability.

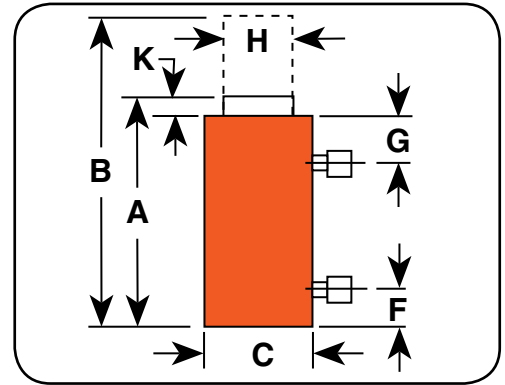

Ordering Information

Cyl. Cap.	Stroke	Order No.	A		B		C		F		G		H		K		Swivel Cap Dia.	Bore Dia.	Cyl. Eff. Area (Advance)	Oil Cap. (Ext.)	Oil Cap. (Ret.)	Int. Press. at Cap.	Tons at 10,000 PSI	Prod. Wt.
			Ret. Height	Ext. Height	Outside Dia.	Base to Port	Top to Port	Piston Rod Dia.	Swivel Cap Protrusion	(in.)	(in.)	(sq. in.)	(cu. in.)	(cu. in.)	(psi)	(tons)								
55	2	RDG552	7.84	9.84	5.16	1.61	1.61	2.75	0.67	2.78	3.75	11.04	22.09	10.23	9959	55.20	39.20							
	4	RDG554	9.84	13.84	5.16	1.61	1.61	2.75	0.67	2.78	3.75	11.04	44.18	20.45	9959	55.20	48.20							
	6	RDG556	11.84	17.84	5.16	1.61	1.61	2.75	0.67	2.78	3.75	11.04	66.27	30.68	9959	55.20	60.10							
	8	RDG558	13.84	21.84	5.16	1.61	1.61	2.75	0.67	2.78	3.75	11.04	88.36	40.90	9959	55.20	69.10							
	10	RDG5510	15.84	25.84	5.16	1.61	1.61	2.75	0.67	2.78	3.75	11.04	110.45	51.13	9959	55.20	78.00							
	12	RDG5512	17.84	29.84	5.16	1.61	1.61	2.75	0.67	2.78	3.75	11.04	132.54	61.35	9959	55.20	87.05							
	13	RDG5513	18.84	31.84	5.16	1.61	1.61	2.75	0.67	2.78	3.75	11.04	143.58	66.47	9959	55.20	91.50							
	14	RDG5514	19.84	33.84	5.16	1.61	1.61	2.75	0.67	2.78	3.75	11.04	154.63	71.58	9959	55.20	95.90							
75	2	RDG752	8.31	10.31	5.78	1.76	1.76	3.12	0.76	3.24	4.38	15.03	30.06	14.74	9979	75.20	51.60							
	4	RDG754	10.31	14.31	5.78	1.76	1.76	3.12	0.76	3.24	4.38	15.03	60.13	29.48	9979	75.20	67.40							
	6	RDG756	12.31	18.31	5.78	1.76	1.76	3.12	0.76	3.24	4.38	15.03	90.19	44.23	9979	75.20	78.16							
	8	RDG758	14.31	22.31	5.78	1.76	1.76	3.12	0.76	3.24	4.38	15.03	120.26	58.97	9979	75.20	88.90							
	10	RDG7510	16.31	26.31	5.78	1.76	1.76	3.12	0.76	3.24	4.38	15.03	150.32	73.71	9979	75.20	99.60							
	12	RDG7512	18.31	30.31	5.78	1.76	1.76	3.12	0.76	3.24	4.38	15.03	180.39	88.45	9979	75.20	110.33							
	13	RDG7513	19.31	32.31	5.78	1.76	1.76	3.12	0.76	3.24	4.38	15.03	195.42	95.82	9979	75.20	115.70							
	14	RDG7514	20.31	34.31	5.78	1.76	1.76	3.12	0.76	3.24	4.38	15.03	210.45	103.20	9979	75.20	121.10							
100	2	RDG1002	8.70	10.70	6.53	1.85	1.85	3.75	0.92	3.87	5.13	20.63	41.27	19.21	9692	103.10	71.10							
	4	RDG1004	10.70	14.70	6.53	1.85	1.85	3.75	0.92	3.87	5.13	20.63	82.54	38.43	9692	103.10	84.60							
	6	RDG1006	12.70	18.70	6.53	1.85	1.85	3.75	0.92	3.87	5.13	20.63	123.81	57.64	9692	103.10	98.10							
	8	RDG1008	14.70	22.70	6.53	1.85	1.85	3.75	0.92	3.87	5.13	20.63	165.08	76.86	9692	103.10	111.60							
	10	RDG10010	16.70	26.70	6.53	1.85	1.85	3.75	0.92	3.87	5.13	20.63	206.35	96.07	9692	103.10	125.20							
	12	RDG10012	18.70	30.70	6.53	1.85	1.85	3.75	0.92	3.87	5.13	20.63	247.62	115.29	9692	103.10	138.70							
	13	RDG10013	19.70	32.70	6.53	1.85	1.85	3.75	0.92	3.87	5.13	20.63	268.25	124.90	9692	103.10	145.40							
	14	RDG10014	20.70	34.70	6.53	1.85	1.85	3.75	0.92	3.87	5.13	20.63	288.88	134.50	9692	103.10	152.20							
150	2	RDG1502	9.37	11.37	7.70	2.11	2.11	4.50	0.95	4.63	6.25	30.68	61.37	29.60	9777	153.40	103.00							
	4	RDG1504	11.37	15.37	7.70	2.11	2.11	4.50	0.95	4.63	6.25	30.68	122.73	59.21	9777	153.40	121.00							
	6	RDG1506	13.37	19.37	7.70	2.11	2.11	4.50	0.95	4.63	6.25	30.68	184.10	88.81	9777	153.40	139.00							
	8	RDG1508	15.37	23.37	7.70	2.11	2.11	4.50	0.95	4.63	6.25	30.68	245.47	118.41	9777	153.40	157.00							
	10	RDG15010	17.37	27.37	7.70	2.11	2.11	4.50	0.95	4.63	6.25	30.68	306.84	148.02	9777	153.40	175.10							
	12	RDG15012	19.37	31.37	7.70	2.11	2.11	4.50	0.95	4.63	6.25	30.68	368.20	177.62	9777	153.40	193.10							
	13	RDG15013	20.37	33.37	7.70	2.11	2.11	4.50	0.95	4.63	6.25	30.68	398.89	192.42	9777	153.40	202.10							
	14	RDG15014	21.37	35.37	7.70	2.11	2.11	4.50	0.95	4.63	6.25	30.68	429.57	207.22	9777	153.40	211.10							
200	2	RDG2002	10.04	12.04	8.93	2.25	2.25	5.25	1.06	5.37	7.25	41.28	82.57	39.33	9689	206.40	148.70							
	4	RDG2004	12.04	16.04	8.93	2.25	2.25	5.25	1.06	5.37	7.25	41.28	165.14	78.66	9689	206.40	173.10							
	6	RDG2006	14.04	20.04	8.93	2.25	2.25	5.25	1.06	5.37	7.25	41.28	247.71	117.99	9689	206.40	197.40							
	8	RDG2008	16.04	24.04	8.93	2.25	2.25	5.25	1.06	5.37	7.25	41.28	330.27	157.31	9689	206.40	221.80							
	10	RDG20010	18.04	28.04	8.93	2.25	2.25	5.25	1.06	5.37	7.25	41.28	412.84	196.64	9689	206.40	246.20							
	12	RDG20012	20.04	32.04	8.93	2.25	2.25	5.25	1.06	5.37	7.25	41.28	495.41	235.97	9689	206.40	270.50							
	13	RDG20013	21.04	34.04	8.93	2.25	2.25	5.25	1.06	5.37	7.25	41.28	536.70	255.64	9689	206.40	282.70							
	14	RDG20014	22.04	36.04	8.93	2.25	2.25	5.25	1.06	5.37	7.25	41.28	577.98	275.30	9689	206.40	294.90							

Model Shown:
RDG Family



Features

HEAVY LIFT, GENERAL PURPOSE CYLINDER FOR TOUGH MAINTENANCE APPLICATIONS.

- Double-Acting, hydraulic return cylinders, tonnages ranging from 250 - 600.
- Patented swivel cap provides concentrated load centering up to 5 degrees.
- Safety relief valve prevents over-pressurization of the retract circuit.
- Sealing technology provides lubrication to reduce friction and wear.
- "Power-Tech" nitro-carburization surface treatment inhibits corrosion and provides exceptional durability.
- Floating piston design resists side loading conditions.
- Two high flow 3/8" NPTF female half coupler and removable carry strap w/ eyelets are included.
- Base mounting holes standard on all models (they are not maintained to port location).
- Complies with ANSI / ASME B30.1 Safety Standards.

▶ RDG Series is perfect for mining MRO application.



RDG Series Design Features

- Patented swivel cap minimizes side load conditions
- Robust retaining ring withstands full load end stop
- Seal band technology reduces wear and provides lubricity
- Power-Tech surface treatment provides extended durability
- Heavy-duty, heat treated piston rod for the most demanding applications
- Self-Aligning piston gland design Resists side loading
- Carrying eyelets for ease of positioning
- Design complies with AMSE / ANSI B30.1 Safety Standard
- High pressure 3/8 NPTF Female Half Coupler(s) included

RDG10012 cutaway shown

▶ **Technical Dimensions, Base Mounting Holes**

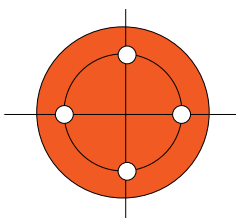

Four base mounting holes are 45° apart - standard on all models.

Tonnage	250	300	400	500	600
# of Base Mounting Holes	4	4	4	4	4
Base thread size	M24X3.0 - 6H	M24X3.0 - 6H	M30X3.5 - 6H	M30X3.5 - 6H	M33X2.0 - 6H
Base thread depth (in)	1.46	1.46	1.80	1.80	1.95
Base Mounting Diameter (in.)	6.06	7.06	7.65	8.95	9.65
Base Mounting Orientation	Mounting hole orientation is not maintained to port location.				



Cylinder Selection



Power Team recommends using 80% of the rated capacity and stroke to maximize product performance and safety.

Custom stroke lengths are available, contact your local Power Team Sales Office for details and availability.

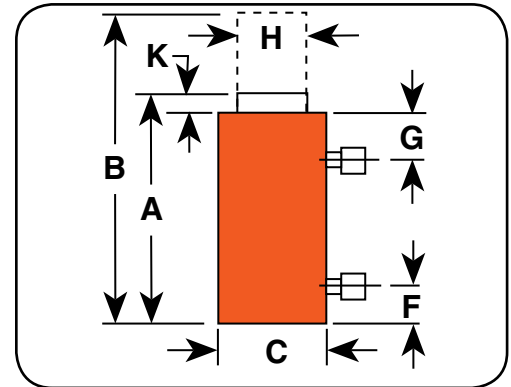

Ordering Information

Cyl. Cap.	Stroke	Order No.	A	B	C	F	G	H	K	Swivel Cap Dia.	Bore Dia.	Cyl. Eff. Area (Advance)	Oil Cap. (Ext.)	Oil Cap. (Ret.)	Int. Press. at Cap.	Tons at 10,000 PSI	Prod. Wt.
			Ret. Height	Ext. Height	Outside Dia.	Base to Port	Top to Port	Piston Rod Dia.	Swivel Cap Protrusion								
(tons)	(in.)		(in.)	(in.)	(in.)	(in.)	(in.)	(in.)	(in.)	(in.)	(in.)	(sq. in.)	(cu. in.)	(cu. in.)	(psi)	(tons)	(lbs.)
250	2	RDG2502	10.30	12.30	9.85	2.35	2.35	6.00	1.12	5.56	8.00	50.27	100.53	44.05	9947	251.30	192.30
	4	RDG2504	12.30	16.30	9.85	2.35	2.35	6.00	1.12	5.56	8.00	50.27	201.06	88.10	9947	251.30	223.00
	6	RDG2506	14.30	20.30	9.85	2.35	2.35	6.00	1.12	5.56	8.00	50.27	301.59	132.14	9947	251.30	253.80
	8	RDG2508	16.30	24.30	9.85	2.35	2.35	6.00	1.12	5.56	8.00	50.27	402.12	176.19	9947	251.30	284.50
	10	RDG25010	18.30	28.30	9.85	2.35	2.35	6.00	1.12	5.56	8.00	50.27	502.65	220.24	9947	251.30	315.20
	12	RDG25012	20.30	32.30	9.85	2.35	2.35	6.00	1.12	5.56	8.00	50.27	603.18	264.29	9947	251.30	345.90
	13	RDG25013	21.30	34.30	9.85	2.35	2.35	6.00	1.12	5.56	8.00	50.27	653.45	286.31	9947	251.30	361.30
	14	RDG25014	22.30	36.30	9.85	2.35	2.35	6.00	1.12	5.56	8.00	50.27	703.71	308.34	9947	251.30	376.70
300	2	RDG3002	10.74	12.74	11.08	2.48	2.48	6.50	1.28	6.66	9.00	63.61	127.23	60.93	9432	318.10	251.40
	4	RDG3004	12.74	16.74	11.08	2.48	2.48	6.50	1.28	6.66	9.00	63.61	254.45	121.87	9432	318.10	288.80
	6	RDG3006	14.74	20.74	11.08	2.48	2.48	6.50	1.28	6.66	9.00	63.61	381.68	182.80	9432	318.10	326.20
	8	RDG3008	16.74	24.74	11.08	2.48	2.48	6.50	1.28	6.66	9.00	63.61	508.91	243.74	9432	318.10	363.60
	10	RDG30010	18.74	28.74	11.08	2.48	2.48	6.50	1.28	6.66	9.00	63.61	636.13	304.67	9432	318.10	401.00
	12	RDG30012	20.74	32.74	11.08	2.48	2.48	6.50	1.28	6.66	9.00	63.61	763.36	365.61	9432	318.10	438.40
	13	RDG30013	21.74	34.74	11.08	2.48	2.48	6.50	1.28	6.66	9.00	63.61	826.97	396.08	9432	318.10	457.10
	14	RDG30014	22.74	36.74	11.08	2.48	2.48	6.50	1.28	6.66	9.00	63.61	890.59	426.54	9432	318.10	475.80
400	2	RDG4002	12.07	14.07	12.93	2.77	2.77	7.50	1.46	7.77	10.50	86.58	173.16	84.89	9240	433.00	390.60
	4	RDG4004	14.07	18.07	12.93	2.77	2.77	7.50	1.46	7.77	10.50	86.58	346.32	169.79	9240	433.00	441.00
	6	RDG4006	16.07	22.07	12.93	2.77	2.77	7.50	1.46	7.77	10.50	86.58	519.48	254.68	9240	433.00	491.40
	8	RDG4008	18.07	26.07	12.93	2.77	2.77	7.50	1.46	7.77	10.50	86.58	692.63	339.57	9240	433.00	541.70
	10	RDG40010	20.07	30.07	12.93	2.77	2.77	7.50	1.46	7.77	10.50	86.58	865.79	424.47	9240	433.00	592.10
	12	RDG40012	22.07	34.07	12.93	2.77	2.77	7.50	1.46	7.77	10.50	86.58	1038.95	509.36	9240	433.00	635.60
	13	RDG40013	23.07	36.07	12.93	2.77	2.77	7.50	1.46	7.77	10.50	86.58	1125.53	551.80	9240	433.00	667.70
	14	RDG40014	24.07	38.07	12.93	2.77	2.77	7.50	1.46	7.77	10.50	86.58	1212.11	594.25	9240	433.00	692.90
500	2	RDG5002	12.28	14.28	14.16	2.90	2.90	8.00	1.55	8.51	11.50	103.85	207.70	107.27	9629	519.30	471.30
	4	RDG5004	14.28	18.28	14.16	2.90	2.90	8.00	1.55	8.51	11.50	103.85	415.41	214.55	9629	519.30	530.20
	6	RDG5006	16.28	22.28	14.16	2.90	2.90	8.00	1.55	8.51	11.50	103.85	623.11	321.82	9629	519.30	589.10
	8	RDG5008	18.28	26.28	14.16	2.90	2.90	8.00	1.55	8.51	11.50	103.85	830.82	429.10	9629	519.30	647.90
	10	RDG50010	20.28	30.28	14.16	2.90	2.90	8.00	1.55	8.51	11.50	103.85	1038.52	536.37	9629	519.30	706.80
	12	RDG50012	22.28	34.28	14.16	2.90	2.90	8.00	1.55	8.51	11.50	103.85	1246.23	643.65	9629	519.30	765.70
	13	RDG50013	23.28	36.28	14.16	2.90	2.90	8.00	1.55	8.51	11.50	103.85	1350.08	697.29	9629	519.30	795.10
	14	RDG50014	24.28	38.28	14.16	2.90	2.90	8.00	1.55	8.51	11.50	103.85	1453.93	750.92	9629	519.30	824.60
600	2	RDG6002	12.76	14.76	15.40	3.02	3.02	9.00	1.63	9.25	12.50	122.70	245.39	118.28	9780	613.60	562.20
	4	RDG6004	14.76	18.76	15.40	3.02	3.02	9.00	1.63	9.25	12.50	122.70	490.78	236.56	9780	613.60	634.30
	6	RDG6006	16.76	22.76	15.40	3.02	3.02	9.00	1.63	9.25	12.50	122.70	736.17	354.83	9780	613.60	706.40
	8	RDG6008	18.76	26.76	15.40	3.02	3.02	9.00	1.63	9.25	12.50	122.70	981.56	473.11	9780	613.60	778.50
	10	RDG60010	20.76	30.76	15.40	3.02	3.02	9.00	1.63	9.25	12.50	122.70	1226.96	591.39	9780	613.60	850.60
	12	RDG60012	22.76	34.76	15.40	3.02	3.02	9.00	1.63	9.25	12.50	122.70	1472.35	709.67	9780	613.60	922.70
	13	RDG60013	23.76	36.76	15.40	3.02	3.02	9.00	1.63	9.25	12.50	122.70	1595.04	768.80	9780	613.60	958.70
	14	RDG60014	24.76	38.76	15.40	3.02	3.02	9.00	1.63	9.25	12.50	122.70	1717.74	827.94	9780	613.60	994.80

Model Shown:
RD10013, RD556, RD300



Features

HIGH TONNAGE PREMIUM DESIGN FOR HIGH CYCLE LIFE.

- Perfect for bridge lifting, building reconstruction, shipyard, utility and mining equipment maintenance.
- Aluminum bronze overlay bearings provide long life.
- Chrome plated piston rod resists corrosion.
- Rod and collar threads are designed to withstand full tonnage.
- Grooved ring pattern in load cap helps guard against load slippage.
- Each cylinder has two 9796 3/8" NPTF female half couplers.
- Built-in safety relief valve prevents over-pressurization of the retract circuit.
- Feature mounting holes and collar threads.
- Complies with ANSI / ASME B30.1 Safety Standards.



RD Series Design Features

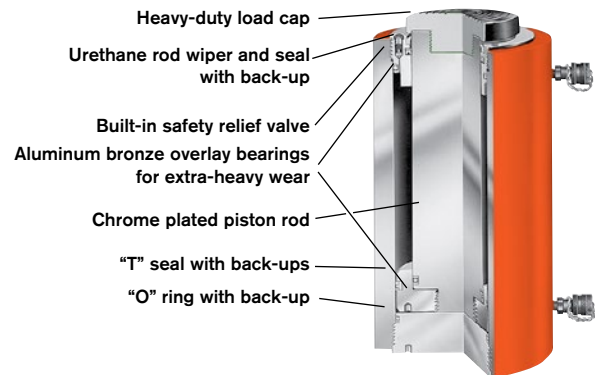

RD Series Performance

The table at right gives you an idea of what to expect when coupling RD series cylinders to a Power Team pump. Actual performance will vary according to job conditions.

Pump	Cylinder	Time to Extend Cylinder 1"	
		100 psi	10,000 psi
PE55	RD55	1.0 sec.	12.0 sec.
	RD100	1.8 sec.	22.5 sec.
	RD200	3.5 sec.	45.0 sec.
	RD400	7.2 sec.	85.0 sec.
PQ120 Series	RD200	3.4 sec.	20.6 sec.
	RD300	4.9 sec.	30.0 sec.
	RD400	6.4 sec.	39.0 sec.
PE400 Series	RD300	3.0 sec.	8.5 sec.
	RD400	3.9 sec.	11.1 sec.
	RD500	4.9 sec.	14.1 sec.

▶ Four special order 500 ton, 24" stroke cylinders used in a swaging press for crimping 3 1/2" wire rope.



Technical Dimensions, Base Mounting Holes

Cylinder Tonnage	10	25	55	80	100	150	200	300	400	500
# of Holes	2	4	4	4	4		4	4	4	6
Thread Size	3/8"-16	1/2"-13	5/8"-11	5/8"-11	3/4"-10	1"-8	1 1/4"-7	1 1/4"-7	1 1/2"-12	1 3/8"-12
Thread Depth (in)	0.63	0.75	0.88	0.88	1.00	1.00	1.25	1.75	1.88	2.00
Bolt Circle Diameter (in.)	2.00	2.75	3.50	4.50	5.50	6.00	6.50	6.25	7.25	8.00
Orientation*	90°	45°	45°	45°	45°	45°	45°	Random	Random	Random

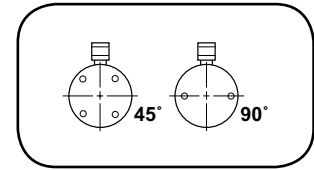

NOTE: Base mounting holes are standard on all RD cylinders. *Orientation of base mounting holes to coupler.

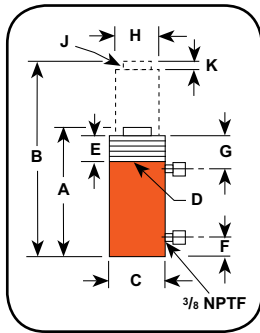

Optional Swivel Load Caps Ordering Info

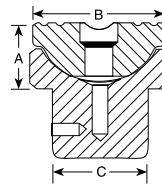

Cylinder Tonnage	Swivel Cap Order No.	Wt. (lbs.)	A (in.)	B (in.)	C (in.)
10	350144	0.8	0.88	1.44	0.86
25	350145	1.3	1.13	2.13	1.44
55	351325	4.2	2.44	2.50	1.55
100	351324	11.2	2.95	3.75	2.66
150/200	351334	12.8	2.63	4.38	3.06

Ordering Information

Cyl. Cap.	Stroke	Order No.	Oil Cap.	A		B		C		D		E		F		G		H		J		K		Load Cap. Dia.	Bore Dia.	Cylinder Effective Area		Int. Press. at Cap.		Tons at 10,000		Prod. Wt.
				Re-tracted Height	Ex-tended Height	Outside Dia.	Collar Thread Size	Thread Length Thread	Base to Port	Cyl. Piston Top to Port	Piston Rod Dia.	Rod Int. Thread & Depth	Piston Rod Protrusion	Push	Pull	Push	Pull	Push	Pull	Push	Pull											
				(in.)	(in.)	(in.)	(in.)	(in.)	(in.)	(in.)	(in.)	(in.)	(in.)	(in.)	(in.)	(in.)	(in.)	(in.)	(in.)	(in.)	(in.)	(in.)	(in.)			(in.)	(in.)	(in.)	(in.)	(in.)	(in.)	
10	4	6.25	RD106	13.9	5.5	11.69	17.94	3.00	2 3/4 - 12	1.63	1.00	2.50	0.94	1-8 x 1	0.25	1.38	1.69	2.23	0.88	8,943	9,055	11.2	4.4	22.0								
	4	10.00	RD1010	22.3	8.8	15.69	25.69	3.00	2 3/4 - 12	1.63	1.00	2.50	0.94	1-8 x 1	0.25	1.38	1.69	2.23	0.88	8,943	9,055	11.2	4.4	28.0								
25	8	6.25	RD256	32.2	10.1	12.38	18.63	4.00	4 - 12	1.63	1.00	2.50	2.13	1 1/2-16 x 1	0.38	2.13	2.56	5.15	1.61	9,695	9,934	25.8	8.0	39.8								
	8	14.25	RD2514	73.5	22.9	20.38	34.63	4.00	4 - 12	1.63	1.00	2.50	2.13	1 1/2-16 x 1	0.38	2.13	2.56	5.15	1.61	9,695	9,934	25.8	8.0	65.0								
55	28	6.25	RD556	69.0	35.2	12.97	19.22	5.00	5 - 12	1.63	1.31	2.50	2.63	1 11/16-8 x 13/16	0.63	2.63	3.75	11.04	5.63	9,959	9,941	55.2	28.2	61.4								
	28	13.13	RD5513	144.9	73.9	19.84	32.97	5.00	5 - 12	1.63	1.29	2.50	2.63	1 11/16-8 x 13/16	0.63	2.63	3.75	11.04	5.63	9,959	9,941	55.2	28.2	90.0								
80	28	18.13	RD5518	200.0	102.0	25.88	44.00	5.00	5 - 12	1.63	1.28	2.50	2.63	1 11/16-8 x 13/16	0.63	2.63	3.75	11.04	5.63	9,959	9,941	55.2	28.2	142.0								
	44	13.13	RD8013	208.6	115.9	20.38	33.50	5.75	5 3/4 - 12	1.63	1.50	2.50	3.00	2-4 1/2 x 1 1/2	0.56	2.88	4.50	15.9	8.84	10,060	9,954	79.5	44.2	118.0								
100	44	6.63	RD1006	136.7	58.5	13.78	20.41	6.88	6 7/8 - 12	1.63	1.50	2.50	3.88	2 3/4-12 x 1 5/32	0.63	3.88	5.13	20.63	8.84	9,695	9,959	103.1	44.2	126.0								
	44	13.13	RD10013	270.7	116.0	20.28	33.41	6.88	6 7/8 - 12	1.63	1.50	2.50	3.88	2 3/4-12 x 1 5/32	0.63	3.88	5.13	20.63	8.84	9,695	9,959	103.1	44.2	181.0								
	44	20.13	RD10020	415.2	178.0	30.50	50.63	6.88	6 7/8 - 12	1.63	2.78	2.50	3.88	2 3/4-12 x 1 5/32	0.63	3.88	5.13	20.63	8.84	9,695	9,959	103.1	44.2	260.0								
150	73	6.63	RD1506	203.3	97.9	14.88	21.50	8.25	8 1/4 - 12	1.63	2.00	2.50	4.50	3 1/4-8 x 1 1/2	0.81	4.50	6.25	30.68	14.78	9,779	9,880	153.4	73.8	188.0								
	73	13.13	RD15013	402.7	193.9	21.38	34.50	8.25	8 1/4 - 12	1.63	2.00	2.50	4.50	3 1/4-8 x 1 1/2	0.81	4.50	6.25	30.68	14.78	9,779	9,880	153.4	73.8	272.0								
	73	18.13	RD15018	556.8	267.8	26.53	44.66	8.25	8 1/4 - 12	1.63	2.00	2.50	4.50	3 1/4-8 x 1 1/2	0.75	4.50	6.25	30.68	14.78	9,779	9,880	153.4	73.8	376.0								
200	113	6.63	RD2006	273.5	149.8	16.00	22.63	9.50	9 1/2 - 12	1.63	2.50	2.69	4.88	3 1/4-8 x 2 1/4	1.06	4.50	7.25	41.28	22.62	9,689	9,992	206.4	113.1	262.0								
	113	13.13	RD20013	541.8	296.9	22.50	35.63	9.50	9 1/2 - 12	1.63	2.33	2.69	4.88	3 1/4-8 x 2 1/4	1.06	4.50	7.25	41.28	22.62	9,689	9,992	206.4	113.1	356.0								
	113	18.13	RD20018	748.2	409.9	28.50	46.63	9.50	9 1/2 - 12	1.63	2.25	2.69	4.88	3 1/4-8 x 2 1/4	1.06	4.50	7.25	41.28	22.62	9,689	9,992	206.4	113.1	442.0								
300	147	6.00	RD3006	361.0	177.0	17.28	23.28	10.75	10 1/2 - 12	2.38	3.38	3.38	6.25	2 1/2-12 x 3 1/4	1.13	6.88	8.75	60.13	29.45	9,978	10,000	300.7	147.3	380.0								
	147	13.00	RD30013	782.0	383.0	24.81	37.81	10.75	10 1/2 - 12	2.38	3.38	3.38	6.25	2 1/2-12 x 3 1/4	1.13	6.88	8.75	60.13	29.45	9,978	10,000	300.7	147.3	654.0								
400	186	6.00	RD4006	471.0	247.0	19.28	25.28	12.63	12 1/2 - 8	2.75	3.84	3.84	7.25	3-12 x 3 3/4	1.25	7.81	10.00	78.54	37.26	10,185	10,000	392.7	186.3	585.0								
	186	13.00	RD40013	1021.0	536.0	26.28	39.28	12.63	12 1/2 - 8	2.75	3.82	3.84	7.25	3-12 x 3 3/4	1.25	7.81	10.00	78.54	37.26	10,185	10,000	392.7	186.3	770.0								
500	245	6.00	RD5006	596.0	295.0	20.56	26.56	14.75	14 3/4 - 8	3.13	4.16	4.16	8.00	3 1/4-12 x 4 1/4	1.5	8.50	11.25	99.40	49.14	10,060	10,000	497.0	245.6	819.0								
	245	13.00	RD50013	1292.0	639.0	27.56	40.56	14.75	14 3/4 - 8	3.13	4.16	4.16	8.00	3 1/4-12 x 4 1/4	1.5	8.50	11.25	99.40	49.14	10,060	10,000	497.0	245.6	1092.0								

Model Shown:

R2802C



Technical Dimensions

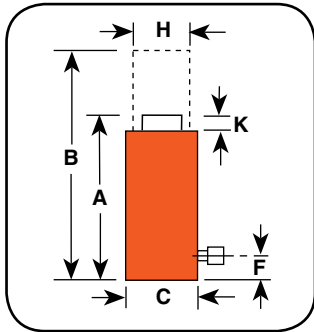

Ordering Information

Cyl. Cap.	Stroke	Order No.	Oil Cap.	A	B	C	F	H	K	Bore Dia.	Cylinder Effective Area	Int. Press. at Cap.	Tons at 10,000	Prod. Wt.
				Retracted Height	Extended Height	Outside Dia.	Base to Port	Piston Rod Dia.	Piston Rod Protrusion					
(tons)	(in.)		(cu. in.)	(in.)	(in.)	(in.)	(in.)	(in.)	(in.)	(in.)	(sq. in.)	(psi)	(tons)	(lbs.)
55	2	R552C	22.1	4.94	6.94	5.00	1.00	3.75	0.13	3.75	11.04	9,960	55.2	27
	6	R556C	66.3	8.94	14.94	5.00	1.00	3.75	0.13	3.75	11.04	9,960	55.2	50
	10	R5510C	110.4	12.94	22.94	5.00	1.00	3.75	0.13	3.75	11.04	9,960	55.2	72
100	2	R1002C	41.3	5.50	7.50	6.50	1.00	5.13	0.13	5.13	20.63	9,695	103.2	52
	6	R1006C	123.8	9.50	15.50	6.50	1.00	5.13	0.13	5.13	20.63	9,695	103.2	89
150	2	R1502C	61.4	6.38	8.38	8.06	1.25	6.25	0.13	6.25	30.68	9,778	153.4	92
	6	R1506C	184.1	10.38	16.38	8.06	1.25	6.25	0.13	6.25	30.68	9,778	153.4	151
	10	R15010C	306.8	14.38	24.38	8.06	1.25	6.25	0.13	6.25	30.68	9,778	153.4	210
200	2	R2002C	82.6	7.50	9.50	9.25	1.63	7.25	0.13	7.25	41.28	9,690	206.4	145
	6	R2006C	247.7	11.50	17.50	9.25	1.63	7.25	0.13	7.25	41.28	9,690	206.4	221
280	2	R2802C	113.5	7.50	9.50	10.25	1.63	8.50	0.13	8.50	56.74	9,870	283.7	201
	6	R2806C	340.4	11.50	17.50	10.88	1.63	8.50	0.13	8.50	56.74	9,870	283.7	300
355	2	R3552C	141.8	9.13	11.13	11.75	2.13	9.50	0.13	9.50	70.88	10,017	354.4	302
	6	R3556C	425.3	13.13	19.13	11.75	2.13	9.50	0.13	9.50	70.88	10,017	354.4	434
	10	R35510C	708.8	17.13	27.13	11.75	2.13	9.50	0.13	9.50	70.88	10,017	354.4	565
430	2	R4302C	173.2	10.38	12.38	13.00	2.50	10.50	0.13	10.50	86.59	9,932	433.0	440
	6	R4306C	519.5	14.38	20.38	13.00	2.50	10.50	0.13	10.50	86.59	9,932	433.0	609
565	2	R5652C	226.2	11.50	13.50	14.88	2.75	12.00	0.13	12.00	113.10	9,991	565.5	638
	6	R5656C	678.6	15.50	21.50	14.88	2.75	12.00	0.13	12.00	113.10	9,991	565.5	858
	10	R56510C	1131	19.50	29.50	14.88	2.75	12.00	0.13	12.00	113.10	9,991	565.5	1078

Features

HIGH-TONNAGE, LOW CYCLE APPLICATION, GRAVITY RETURN.

- Visible indicator band alerts when stroke limit is reached. Overflow port (weep hole) stroke limiter prevents piston from being overextended.
- Alloy heat treated piston and body for reliability and strength.
- Plated piston rod increases corrosion resistance and gives superior bearing support.
- Optional swivel load caps reduce the effects of off-center loading tilts up to 5 degrees. Radial grooves on top of cap reduce load slippage.

Optional Swivel Load Caps Ordering Info

Cylinder Tonnage	Swivel Cap Order No.	Wt. (lbs.)	A (in.)	B (in.)
150-200	420867	8.8	1.50	5.13
280	420868	13.5	1.75	5.88
355	420869	37.0	2.75	7.69
430	420870	52.0	3.13	8.88
565	420871	78.0	3.63	9.88

Reduce the effects of off-center loading. Tilt up to 5 degrees. Radial grooves on top of cap reduce load slippage. Notch across face of each cap helps keep loads having a protruding or round shaped centered.

Model Shown:

R2806D, R1502D



Technical Dimensions

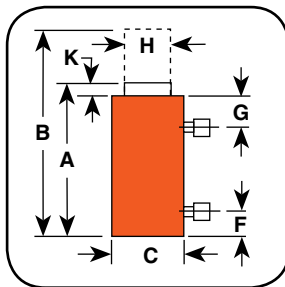

Ordering Information

Cyl. Cap. (tons)	Stroke (in.)	Order No.	Oil Cap.		A Retracted Height (in.)	B Extended Height (in.)	C Outside Dia. (in.)	F Base to Port (in.)	G Cylinder Top to Port (in.)	H Piston Rod Dia. (in.)	K Piston Rod Protrusion (in.)	Bore Dia. (in.)	Cylinder Effective Area (sq. in.)	Int. Press. at Cap. (psi)	Tons at 10,000 (tons)	Prod. Wt. (lbs.)
			(cu. in.)													
			Push	Return												
100	2	R1002D	41.2	19.2	6.64	8.64	6.50	1.00	2.20	3.75	0.28	5.13	20.6	9,695	103.0	54
	6	R1006D	123.6	57.6	10.64	16.64	6.50	1.00	2.20	3.75	0.28	5.13	20.6	9,695	103.0	81
	10	R10010D	206.0	96.0	14.64	24.64	6.50	1.00	2.20	3.75	0.28	5.13	20.6	9,695	103.0	108
150	2	R1502D	61.4	29.6	7.44	9.44	8.06	1.25	2.25	4.50	0.30	6.25	30.7	9,778	153.4	95
	6	R1506D	184.2	88.8	11.44	17.44	8.06	1.25	2.25	4.50	0.30	6.25	30.7	9,778	153.4	136
200	2	R2002D	82.6	39.2	8.14	10.14	9.25	1.63	2.31	5.25	0.34	7.25	41.3	9,690	206.4	136
	6	R2006D	247.8	117.6	12.14	18.14	9.25	1.63	2.31	5.25	0.34	7.25	41.3	9,690	206.4	187
	10	R20010D	413.0	196.0	16.14	26.14	9.25	1.63	2.31	5.25	0.34	7.25	41.3	9,690	206.4	239
280	2	R2802D	113.4	47.2	9.20	11.20	10.88	1.88	2.58	6.50	0.41	8.50	56.7	9,870	283.7	219
	6	R2806D	340.2	141.6	13.20	19.20	10.88	1.88	2.58	6.50	0.41	8.50	56.7	9,870	283.7	297
	10	R28010D	567.0	236.0	17.20	27.20	10.88	1.88	2.58	6.50	0.41	8.50	56.7	9,870	283.7	376
355	2	R3552D	141.8	47.4	2.63	13.38	11.75	2.13	2.75	7.75	0.44	9.50	70.9	10,017	354.4	324
	6	R3556D	425.4	142.2	15.38	21.38	11.75	2.13	2.75	7.75	0.44	9.50	70.9	10,017	354.4	421
430	2	R4302D	173.2	59.6	12.31	14.31	13.00	2.50	2.95	8.50	0.47	10.50	86.6	9,932	433.0	439
	6	R4306D	519.6	178.8	16.31	22.31	13.00	2.50	2.95	8.50	0.47	10.50	86.6	9,932	433.0	558
	10	R43010D	866.0	298.0	20.31	30.31	13.00	2.50	2.95	8.50	0.47	10.50	86.6	9,932	433.0	673
565	2	R5652D	226.2	76.8	13.59	15.59	14.88	2.75	3.20	9.75	0.55	12.00	113.1	9,991	565.5	619
	6	R5656D	678.6	230.4	17.59	23.59	14.88	2.75	3.20	9.75	0.55	12.00	113.1	9,991	565.5	772
	10	R56510D	1131.0	384.0	21.59	31.59	14.88	2.75	3.20	9.75	0.55	12.00	113.1	9,991	565.5	926

Features

HIGH-TONNAGE, LOW CYCLE, HYDRAULIC RETURN CYLINDERS.

- Cylinders come standard with swivel caps to reduce the effects of off-center loading.
- Cylinders may be “dead-ended” without damage.
- Hard chrome plated, heat treated piston rod reduces wear on piston and gland nut.
- Built-in safety relief valve prevents over-pressurization of the retraction circuit.
- Each cylinder has two 9796 3/8" NPTF female half couplers.



Hydraulic Hoses

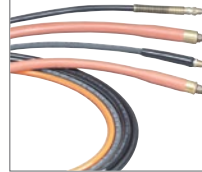

Heavy-duty and thermo plastic hydraulic hoses to meet your requirements and safety factor.

Refer to the accessories section for details.

Model Shown:
RC7406C



Technical Dimensions

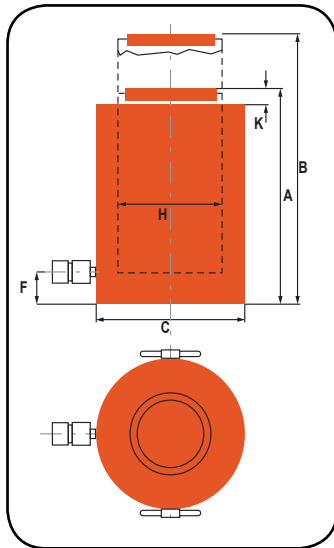

Features

HIGH-TONNAGE, LOW CYCLE, GRAVITY RETURN CYLINDERS.

- Overflow port (weep hole) prevents piston from being overextended under load.
- Alloy heat treated piston and body for reliability and strength.
- Plated piston rod increases corrosion resistance and gives superior bearing support.
- Complies with ANSI / ASME B30.1 Safety Standards.



Optional Swivel Load Caps Ordering Info

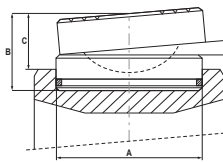

Reduce the effects of off-center loading. Tilt up to 5 degrees. Radial grooves on top of cap reduce load slippage. Notch across face of each cap helps keep loads having a round shaped center.

Used with Cylinder	Swivel Cap Order No.	Wt. (lbs.)	A (in.)	B (in.)	C (in.)
RC740_C, RC965_C	2000824	158.7	11.4	5.5	3.9
RC1220_C	2000825	249.1	12.7	6.9	4.9



Hydraulic Hoses



Heavy-duty and thermo plastic hydraulic hoses to meet your requirements and safety factor.

Refer to the accessories section for details.

Ordering Information

Cyl. Cap. (tons)	Stroke (in.)	Order No.	Oil Cap. (cu. in.)	A	B	C	F	H	K	Bore Dia. (in.)	Cylinder Effective Area (sq. in.)	Tons at 10,000 (tons)	Prod. Wt. (lbs.)
				Retracted Height (in.)	Extended Height (in.)	Outside Dia. (in.)	Base to Port (in.)	Piston Rod Dia. (in.)	Piston Rod Protrusion (in.)				
740	2	RC7402C	293.6	10.40	12.40	16.90	2.60	13.80	0.40	13.80	149.10	742	661
	6	RC7406C	880.7	14.40	20.30	16.90	2.60	13.80	0.40	13.80	149.10	742	917
	10	RC74010C	1467.8	18.30	28.10	16.90	2.60	13.80	0.40	13.80	149.10	742	1168
965	2	RC9652C	383.2	11.40	13.40	19.30	2.80	15.70	0.40	15.70	194.80	970	933
	6	RC9656C	1150.2	15.40	21.30	19.30	2.80	15.70	0.40	15.70	194.80	970	1272
	10	RC96510C	1916.2	19.30	29.10	19.30	2.80	15.70	0.40	15.70	194.80	970	1598
1220	2	RC12202C	485.1	16.30	18.10	21.70	3.10	17.70	0.40	17.70	246.50	1227	1689
	6	RC12206C	1455.8	20.20	26.10	21.70	3.10	17.70	0.40	17.70	246.50	1227	2116
	10	RC122010C	2452.2	24.40	34.20	21.70	3.10	17.70	0.40	17.70	246.50	1227	2539

Model Shown:
RC7406D



Technical Dimensions

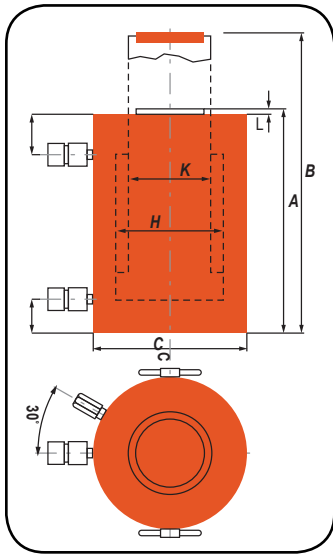

Features

HIGH-TONNAGE CYLINDERS RUGGED AND RELIABLE.

- Cylinders come standard with hardened caps.
- Cylinders may be “dead-ended” without damage.
- Safety relief valve prevents over-pressurization of the retract circuit.
- Each cylinder has two 9796 3/8” NPTF female half couplers.
- Complies with ANSI / ASME B30.1 Safety Standards.

Cylinders



Optional Swivel Load Caps Ordering Info

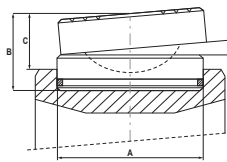

Reduce the effects of off-center loading. Tilt up to 5 degrees. Radial grooves on top of cap reduce load slippage. Notch across face of each cap helps keep loads having a round shaped center.

Used with Cylinder	Swivel Cap Order No.	Wt. (lbs.)	A (in.)	B (in.)	C (in.)
RC740_D	2000822	2.5	7.9	3.1	2.2
RC965_D	2000823	88.2	9.8	4.1	3.0
RC1220_D	2000825	249.1	12.7	6.9	4.9

Ordering Information

Cyl. Cap.	Stroke	Order No.	Oil Cap.	A	B	C	F	G	H	K	L	Cylinder Effective Area	Tons at 10,000	Prod. Wt.
				Retracted Height	Extended Height	Outside Dia.	Base to Port	Cylinder Top to Port	Bore Dia.	Piston Rod Dia.	Piston Rod Protrusion			
(tons)	(in.)		(cu. in.)	(in.)	(in.)	(in.)	(in.)	(in.)	(in.)	(in.)	(in.)	(sq. in.)	(tons)	(lbs.)
740	2.0	RC7402D	293.60	11.10	13.10	16.90	2.60	3.90	13.80	11.01	0.40	149.10	742	670
	6.0	RC7406D	880.70	15.70	21.60	16.90	2.60	3.90	13.80	11.01	0.40	149.10	742	877
	10.0	RC74010D	1467.80	20.00	29.80	16.90	2.60	3.90	13.80	11.01	0.40	149.10	742	1,080
965	2.0	RC9652D	383.20	12.20	14.20	19.30	2.80	4.50	15.70	12.75	0.40	194.80	970	957
	6.0	RC9656D	1150.20	16.50	22.40	19.30	2.80	4.50	15.70	12.75	0.40	194.80	970	1,215
	9.8	RC96510D	1916.20	20.90	30.70	19.30	2.80	4.50	15.70	12.75	0.40	194.80	970	1,473
1220	2.0	RC12202D	485.10	13.00	15.00	21.70	3.10	5.30	17.70	14.17	0.40	246.50	1227	1,287
	6.0	RC12206D	1455.80	17.30	23.20	21.70	3.10	5.30	17.70	14.17	0.40	246.50	1227	1,612
	10.0	RC122010D	2452.20	21.70	31.50	21.70	3.10	5.30	17.70	14.17	0.40	246.50	1227	1,936

Model Shown:
RA1006L, RA556L



Features

POSITIVE MECHANICAL LOCKING COLLAR TO SUPPORT EXTENDED LOAD HOLDING.

- Supports lifted load for extended periods of time with hydraulic pressure released.
- At half the weight of steel cylinders of comparable capacity, aluminum cylinders are ideal when portability is a key factor.
- Features carrying handle.
- Complies with ANSI / ASME B30.1 Safety Standards.

Technical Dimensions

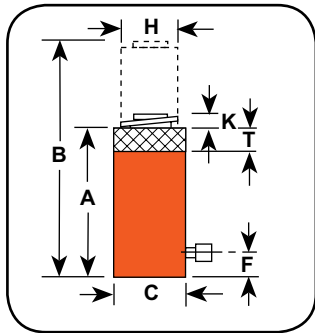

Locking Collar

Locking collar feature permits non-hydraulic support of load.

Learn More - About Hydraulic Safety Insight

Looking for great safety suggestions? Visit our Resource Section to get a better understanding of hydraulic and mechanical safety insights on what to look for when working around hydraulics.

Ordering Information

Cyl. Cap.	Stroke	Order No.	Oil Cap.	A	B	C	F	H	K	T	Bore Dia.	Cylinder Effective Area	Int. Press. at Cap.	Tons at 10,000	Prod. Wt.
				Retracted Height	Extended Height	Outside Dia.	Base to Port	Piston Rod Dia.	Piston Rod Protrusion	Nut Thickness					
(tons)	(in.)		(cu. in.)	(in.)	(in.)	(in.)	(in.)	(in.)	(in.)	(in.)	(in.)	(sq. in.)	(psi)	(tons)	(lbs.)
55	6.13	RA556L	67.6	12.50	18.63	5.25	1.38	3.25	0.50	1.50	3.75	11.04	9,960	55.2	29.6
100	6.25	RA1006L	129	13.38	19.63	7.38	1.19	4.50	0.25	1.50	5.13	20.62	9,696	103.1	64.0

Model Shown:
R556L



Technical Dimensions

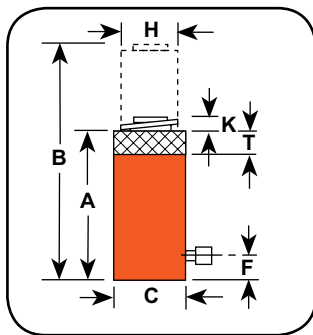

Ordering Information

Cyl. Cap. (tons)	Stroke (in.)	Order No.	Oil Cap. (cu. in.)	A	B	C	F	K	L	T	Bore Dia. (in.)	Cylinder Effective Area (sq. in.)	Int. Press. at Cap. (psi)	Tons at 10,000 (tons)	Prod. Wt. (lbs.)
				Retracted Height (in.)	Extended Height (in.)	Outside Dia. (in.)	Base to Port (in.)	Piston Rod Dia. (in.)	Piston Rod Protrusion (in.)	Nut Thickness (in.)					
55	2.0	R552L	22.1	6.38	8.38	4.94	1.00	3.75	0.13	1.44	3.75	11.04	9,964	55.2	33.7
	6.0	R556L	66.3	10.38	16.38	4.94	1.00	3.75	0.13	1.44	3.75	11.04	9,964	55.2	58.0
	10.0	R5510L	110.4	14.38	24.38	4.94	1.00	3.75	0.13	1.44	3.75	11.04	9,964	55.2	80.0
100	2.0	R1002L	41.3	7.25	9.25	6.50	1.00	5.13	0.13	1.75	5.13	20.63	9,695	103.0	66.0
	6.0	R1006L	123.8	11.25	17.25	6.50	1.00	5.13	0.13	1.75	5.13	20.63	9,695	103.0	103.0
	10.0	R10010L	206.3	15.25	25.25	6.50	1.00	5.13	0.13	1.75	5.13	20.63	9,695	103.0	142.0
150	2.0	R1502L	61.4	8.13	10.13	8.06	1.25	6.25	0.13	1.75	6.25	30.68	9,778	153.4	117.0
	6.0	R1506L	184.1	12.13	18.13	8.06	1.25	6.25	0.13	1.75	6.25	30.68	9,778	153.4	177.0
	10.0	R15010L	306.8	16.13	23.13	8.06	1.25	6.25	0.13	1.75	6.25	30.68	9,778	153.4	235.0
200	2.0	R2002L	82.6	9.50	11.50	9.25	1.63	7.25	0.13	2.00	7.25	41.28	9,690	206.4	183.0
	6.0	R2006L	247.7	13.50	19.50	9.25	1.63	7.25	0.13	2.00	7.25	41.28	9,690	206.4	259.0
	8.0	R2008L	330.3	15.50	23.50	9.25	1.63	7.25	0.13	2.00	7.25	41.28	9,690	206.4	265.0
280	2.0	R2802L	113.5	9.75	11.75	10.88	1.63	8.50	0.13	2.25	8.50	56.74	9,870	283.7	261.0
	6.0	R2806L	340.4	13.75	19.75	10.88	1.63	8.50	0.13	2.25	8.50	56.74	9,870	283.7	359.0
	10.0	R28010L	567.4	17.75	27.75	11.75	1.63	8.50	0.13	2.25	8.50	56.74	9,870	283.7	459.0
355	2.0	R3552L	141.8	11.50	13.50	11.75	2.13	9.50	0.13	2.38	9.50	70.88	10,017	354.4	381.0
	6.0	R3556L	425.3	15.50	21.50	11.75	2.13	9.50	0.13	2.38	9.50	70.88	10,017	354.4	512.0
430	2.0	R4302L	173.2	13.13	15.13	13.00	2.50	10.50	0.13	2.75	10.50	86.59	9,932	433.0	556.0
	6.0	R4306L	519.5	17.13	23.13	13.00	2.50	10.50	0.13	2.75	10.50	86.59	9,932	433.0	725.0
	10.0	R43010L	865.9	21.13	31.13	13.00	2.50	10.50	0.13	2.75	10.50	86.59	9,932	433.0	894.0
565	2.0	R5652L	226.2	14.63	16.63	14.88	2.75	12.00	0.13	3.13	12.00	113.10	9,991	565.5	811.0
	6.0	R5656L	678.6	18.63	24.63	14.88	2.75	12.00	0.13	3.13	12.00	113.10	9,991	565.5	1031.0
	10.0	R56510L	1131	22.63	32.63	14.88	2.75	12.00	0.13	3.13	12.00	113.10	9,991	565.5	1251.0

Features

POSITIVE MECHANICAL LOCKING COLLAR TO SUPPORT LOAD.

- Supports lifted load for extended periods of time with hydraulic pressure released.
- Visible indicator band alerts when stroke limit is reached. Overflow port (“weep hole”) stroke limiter prevents piston from being overextended.
- All cylinders feature coated pistons to resist corrosion and abrasion.
- Complies with ANSI / ASME B30.1 Safety Standards.



Optional Swivel Load Caps Ordering Info

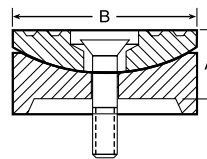

Cylinder Tonnage	Swivel Cap Order No.	Wt. (lbs.)	A (in.)	B (in.)
55-100	420866	1.8	1.00	2.81
150-200	420867	8.8	1.50	5.13
280	420868	13.5	1.75	5.88
355	420869	37.0	2.75	7.69
430	420870	52.0	3.13	8.88
565	420871	78.0	3.63	9.88

Reduce the effects of off-center loading. Tilt up to 5 degrees. Radial grooves on top of cap reduce load slippage. Notch across face of each cap helps keep loads having a round shaped centered.

Model Shown:
RC2402P



Features

LOW HEIGHT POSITIVE MECHANICAL LOCK TO SUPPORT EXTENDED LOAD HOLDING.

- Compact design where space is limited.
- Locking collar designed to support lifted load for extended periods of time with hydraulic pressure released.
- Integral tilt saddle comes standard and improves performance under side load, reducing the effects of off-center loading
- Overflow port (weep hole) prevents piston from being overextended under load.
- Special coating improves corrosion and abrasion resistance.
- Equipped with 3/8" NPTF female half couplers.

Technical Dimensions

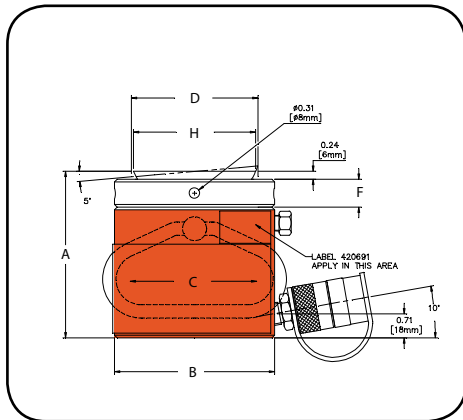

▶ Pancake locking cylinders are ideal for tight quartered locations.



Ordering Information

Cyl. Cap.	Stroke	Order No.	Oil Cap.	A	B	C	D	E	F	G	H	Prod. Wt.
				Retracted Height	Outside Dia.	Bore Dia.	Piston Thread Dia.	Base to Port	Nut Thickness	Swivel Cap Protrusion	Swivel Cap Dia.	
(tons)	(in.)		(cu. in.)	(in.)	(in.)	(in.)	(in.)	(in.)	(in.)	(in.)	(in.)	(lbs.)
55	2.00	RC0552P	21.66	4.92	4.72	3.74	3.74 x 4	0.75	0.83	0.24	3.62	24.25
100	1.75	RC1002P	36.43	5.39	6.50	5.12	5.12 x 6	0.83	1.22	0.31	4.96	48.50
155	1.75	RC1552P	55.23	5.83	8.07	6.30	6.30 x 6	1.06	1.50	0.35	5.83	85.98
240	1.75	RC2402P	86.23	6.10	10.04	7.87	7.87 x 6	1.10	1.57	0.39	6.18	130.07
380	1.75	RC3802P	134.74	7.01	12.60	9.84	9.84 x 6	1.38	1.97	0.43	9.45	242.51
620	1.75	RC6202P	220.78	7.56	15.94	12.60	12.60 x 6	1.50	2.36	0.39	11.61	425.49

Model Shown:

RC7402L, RC9656L



>Features

POSITIVE MECHANICAL LOCK TO SUPPORT LOAD.

- Supports lifted load for extended periods of time with hydraulic pressure released.
- All cylinders feature coated pistons to resist corrosion and abrasion.
- Visible indicator band alerts when stroke limit is reached. Overflow port (weep hole) stroke limiter prevents piston from being overextended.

Cylinders

> Technical Dimensions

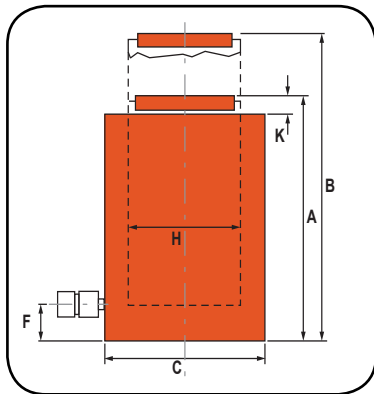

Optional Swivel Load Caps Ordering Info

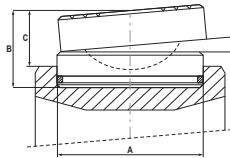

Reduce the effects of off-center loading. Tilt up to 5 degrees. Radial grooves on top of cap reduce load slippage. Notch across face of each cap helps keep loads having a round shaped center.

Used with Cylinder	Swivel Cap Order No.	Wt. (lbs.)	A (in.)	B (in.)	C (in.)
RC740 L, RC965 L	2000824	158.7	11.4	5.5	3.9
RC1220 L	2000825	249.1	12.7	6.9	4.9

> Ordering Information

Cyl. Cap. (tons)	Stroke (in.)	Order No.	Oil Cap. (cu. in.)	A	B	C	F	K	L	Piston Thread Dia. (in.)	Cylinder Effective Area (sq. in.)	Tons at 10,000 (tons)	Prod. Wt. (lbs.)
				Retracted Height (in.)	Extended Height (in.)	Outside Dia. (in.)	Base to Port (in.)	Bore Dia. (in.)	Piston Rod Protrusion (in.)				
740	2	RC7402L	293	12.0	14.0	16.9	2.6	13.8	0.2	13.8 X 6	149.1	746	756
	6	RC7406L	880	16.5	22.4	16.9	2.6	13.8	0.2	13.8 X 6	149.1	746	1,043
	10	RC74010L	1,468	21.1	30.9	16.9	2.6	13.8	0.2	13.8 X 6	149.1	746	1,332
965	2	RC9652L	383	12.8	14.8	19.3	2.8	15.7	0.2	15.7 X 6	194.7	973	1045
	6	RC9656L	1,150	17.3	23.2	19.3	2.8	15.7	0.2	15.7 X 6	194.7	973	1,418
	10	RC96510L	1,917	21.9	31.7	19.3	2.8	15.7	0.2	15.7 X 6	194.7	973	1,792
1220	2	RC12202L	485	13.4	15.4	21.7	3.1	17.7	0.2	17.7 X 6	246.5	1232	1,501
	6	RC12206L	1,456	19.1	25.0	21.7	3.1	17.7	0.2	17.7 X 6	246.5	1232	1,971
	10	RC122010L	2,426	23.6	33.5	21.7	3.1	17.7	0.2	17.7 X 6	246.5	1232	2,441

PUMPS

MARKET LEADING HIGH PRESSURE POWER UNITS FOR A WIDE ARRAY OF APPLICATIONS AND USES.

Every power unit goes through a rigorous assembly and test process to ensure the highest level of performance:

- Power units are available in manual or powered configurations. Powered options include electric, air, and gas.
- A wide array of reservoir sizes from under 0.25 to 55 gallons
- Variety of valve configurations, such as dump, 2-way, 3-way and 4-way in manual and solenoid configurations,
- Whether you are seeking a manual, electrical or an air power pump, Power Team pumps can generate flows up to 420 cu. in. / @ 10,000 PSI.





Section / Series	Power Source	Flow Stages	Flow @ Max Pressure	Page(s)
Introduction	All	All	All	45-48
P	Manual	Single & Two-Speed	12-55 cu. in.	49-51
RPS	Manual	Single & Two-Speed	—	52
PA6	Air	Single-Acting	105 cu. in.	53-54
PA6D	Air	Single-Speed	6 cu. in.	55-56
PA9	Air	Single-Speed	9 cu. in.	57-58
PA60	Air	Two-Speed	6 cu. in.	59-60
PA50	Air	Single-Speed	28 cu. in.	61-62
PA17	Air	Two-Speed	17 cu. in.	63-64
PA46/55	Air	Two-Speed	46-55 cu. in.	65-66
PUA / PMA	Air	Single-Speed	—	67-70
PB	Battery	Two-Speed	6 cu. in.	71-72
PE10	Electric	Two-Speed	10 cu. in.	73-74
PE17	Electric	Two-Speed	17 cu. in.	75-76
PE18	Electric	Two-Speed	18 cu. in.	77-78
PE21	Electric	Two-Speed	22 cu. in.	79-80
PED	Electric	Two-Speed	25 cu. in.	81-82
PE30	Electric	Two-Speed	30 cu. in.	83-84
PE46	Electric	Two-Speed	46 cu. in.	85-86
PE55	Electric	Two-Speed	55 cu. in.	87-88
PE60	Electric	Two-Speed	56 cu. in.	89-90
PQ60	Electric	Two-Speed	60 cu. in.	91-92
PQ120	Electric	Two-Speed	120 cu. in.	93-94
PE400	Electric	Two-Speed	420 cu. in.	95-96
MCS	Electric	Two-Speed	55 cu. in.- 120 cu. in.	97-98
PE-NUT	Electric	Two-Speed	30 cu. in.	99
PG120_CP	Gas	Two-Speed	130 cu. in.	100
PG30/55	Gas	Two-Speed	30-55 cu. in.	101-102
PG120-PG400	Gas	Two-Speed	130-420 cu. in.	103-104
HB Intensifier	Hydraulic	—	Press. Ratio 5:1	105
Assemble to Order	Air, Elec., Gas	Custom Built	—	107-110



SELECTING THE RIGHT PUMP:

Step 1 Select the hydraulic pump that best suits the application.

Step 2 Select the series of pump with adequate oil output and reservoir capacity to power tool.

Step 3 Select pump within series with the valve option that is best suited to the tool and application.

PUMP SIZING CONSIDERATIONS:

1. What maximum system operating pressure (psi) is required?
2. What volume of oil delivery is required? (For manual pumps, cu. in. of oil per handle stroke. For powered pumps, cu. in./min. of oil).
3. Is a single or two-speed pump required? (Two-speed pumps deliver high oil volume at low pressure for rapid cylinder piston advance, then shift to high pressure, low volume stage under load).
4. What is the preferred source of power?
 - a. Manual (hand or foot operated): Provides portability, can be used where electricity or shop air are not available.
 - b. Air/Hydraulic: Uses shop air or a portable air compressor.
 - c. Electric/Hydraulic: What voltage is available? Is a battery operated pump preferred?
 - d. Gasoline Engine/Hydraulic: Powers high-output pumps at remote job sites where air or electricity are unavailable.
5. Is portability of the pump a factor to consider?
6. Will the pump be used intermittently, or will it need to provide high-cycle operation? Does the application require that the pump be capable of starting under load?
7. Is fluid heat build-up a factor in your application? High-cycle applications may require a larger capacity oil reservoir for cooling.
8. Will the application require large displacement or multiple cylinders? Reservoir size and pump output levels will be factors to consider.
9. Does the working environment require a pump having a low operating noise (dBA) level?
10. Must the pump operate in a spark-free environment?





▶ **MANUALLY-OPERATED HYDRAULIC PUMPS:**



- **P12, P23, P55** – These single-speed pumps are for use with single-acting cylinders.
- **P19/P19L, P59/P59L, P59F, P157, P159, P300, P460** – These two-speed pumps are used with single-acting cylinders. The two-speed feature provides high oil volume for fast cylinder piston approach to the work, then the pump automatically shifts to the high pressure stage. This reduces the number of pump handle strokes required.
- **P157D, P159D, P300D, P460D** – These two-speed pumps are used with double-acting cylinders.

▶ **AIR / HYDRAULIC PUMPS:**

Used where air is the preferred energy source or where electricity is not available. Ideal for use in petrochemical, mining or other flammable or explosive environments.



- **PA6 Series** – These single-speed pumps drive single or double-acting cylinders.
- **PA9 Series** – These new single-speed pumps drive single-acting cylinders and are ideal for powering portable hydraulic tools.
- **PA50 Series** – These single-speed pumps drive single or double-acting low pressure (3,200 psi) cylinders.
- **PA60** – This two-speed pump is equipped with a manifold to operate multiple cylinders, and provides a 2-gallon reservoir.
- **PA64** – Similar to PA60, this two-speed pump drives single or double-acting cylinders.
- **PA172 and PA174** – These “economy” two-speed pumps drive single or double-acting cylinders, depending on the model chosen. Provide a low weight-to-output ratio.
- **PA462 and PA464 Series** – These two-speed pumps drive single or double-acting cylinders, depending on the model selected. They offer high speed cylinder piston advance.
- **PA554** – This two-speed pump drives single or double-acting cylinders, delivering a high volume of oil.

▶ **ELECTRIC / HYDRAULIC PUMPS:**

All of the following pumps are two-speed models, and can be used to drive single or double-acting cylinders.



- **PE/PB10 Series “Quarter Horse” Series** – These pumps feature a 1/4 hp electric motor. A battery-powered version is available. Having a low noise level and weighing just 20 lbs. They are ideal for powering portable hydraulic spreaders, nut splitters, pipe flange spreaders and other tools.
- **PE17 Series** – CSA rated for intermittent duty, these feature a 1/2 hp, single-phase induction motor with a low noise level (67-81 dBA). Smaller generators and low amperage circuits can be used as a power source.
- **PE46 Series** – Powered by a 1-1/2 hp, single-phase induction motor, operates at a moderate noise level of 77-81 dBA. CSA rated for intermittent duty.
- **PE18 Series** – CSA rated for intermittent duty, these feature a 1/2 hp, single-phase universal motor with a noise level of 85-90 dBA. Provide high-performance at a low price. Has low amperage draw.
- **PE30 Series** – Equipped with a 1 hp, single-phase permanent magnet motor, have a noise level of only 82-87 dBA. CSA rated for intermittent duty, and requires a relatively low voltage. Ideal for use in general construction applications. Roll cage/handle protects the motor and controls.
- **PE55 and PED25 Series** – Equipped with a 1-1/8 hp, single-phase universal motor, have a 90-95 dBA noise level. Offer the best weight to performance ratio of any Power Team electric/hydraulic pump. CSA rated for intermittent duty. The PED25 versions are “dual flow” pumps which deliver the same low and high pressures to both valves, and have a noise level of 80-85 dBA. They have a 1-1/2 hp induction motor.



▶ **ELECTRIC / HYDRAULIC PUMPS: (CONT.)**



- **PE60 Series** – These Vanguard® Supreme® pumps provide trouble-free service in the most severe working environments. Powered by a 1-1/8 hp, single-phase motor, has a moderate noise level of 80-85 dBA. Starts under load even at the reduced voltages encountered on construction sites. High-output pumps, ideal for use with post-tensioning/pre-stressing jacks and other high-pressure hydraulic tools.
- **“Custom-Built” Pumps** – Power Team offers you “assemble to order” electric/hydraulic pumps to suit unique applications. You can choose from pre-engineered, off-the-shelf components to customize your pump.
- **PE21 Series** – Ideal for heavy-duty, extended-cycle applications. Powered by a 1 hp, single-phase motor, pump operates at a very low noise level of 70 dBA. Pump automatically shuts down in the event of a power failure. CSA rated for intermittent duty.
- **“Quiet” Pumps** – Our PQ60 and PQ120 series operate at a very low noise level of between 73-78 dBA. The PQ60 has a 2 hp (single-phase) motor; the PQ120 has a 3 hp (three-phase) motor. These pumps are designed for heavy-duty, extended cycle operations. CSA rated for intermittent duty.
- **PE400 Series** – High-flow units deliver a large volume of high pressure oil for heavy construction and maintenance operations employing high tonnage cylinders. The PE400 is powered by a 10 hp, three-phase motor. Low noise rating of 73-80 dBA.

▶ **GASOLINE-DRIVEN HYDRAULIC PUMPS:**

These two-speed pumps are ideal for use in remote applications, such as construction sites. May be used with single or double-acting cylinders.



- **PG30 Series** – Powered by a 2-cycle, 2 hp Honda engine, these have an integral, protective “roll cage” and adequate reservoir capacity for cylinders up to 100 tons capacity or more. Readily portable, and popular in the railroad, rescue and construction markets.
- **PG55 Series** – With a 4-cycle, 4 hp Briggs & Stratton engine, this pump is based on our popular Vanguard® Series hydraulic system. It has a generous five gallon reservoir capacity.
- **PG120 Series** – Powered by a 4-cycle, 5.5 hp Honda engine. Has a five gallon reservoir, and is capable of handling multiple-cylinder lifting tasks. Ideal for the structure moving, pier setting, bridge lifting and concrete contracting industries.
- **PG4004** – Featuring a 4-cycle, 18 hp Honda engine, this unit has a big 20 gallon reservoir. Rugged steel “roll cage” has a hook on top and swivel casters for ease of mobility. Popular for concrete stressing applications.

▶ **HYDRAULIC INTENSIFIER:**



- **HB Series** – Turns low pressure hydraulic pumps into high pressure power sources to operate single or double-acting cylinders and tools such as crimper’s, spreaders, cutters, etc. Compact and portable for use inside a utility vehicle aerial bucket or stowing in a vehicle.



**HYDRAULIC
PUMP
OPTIONS**

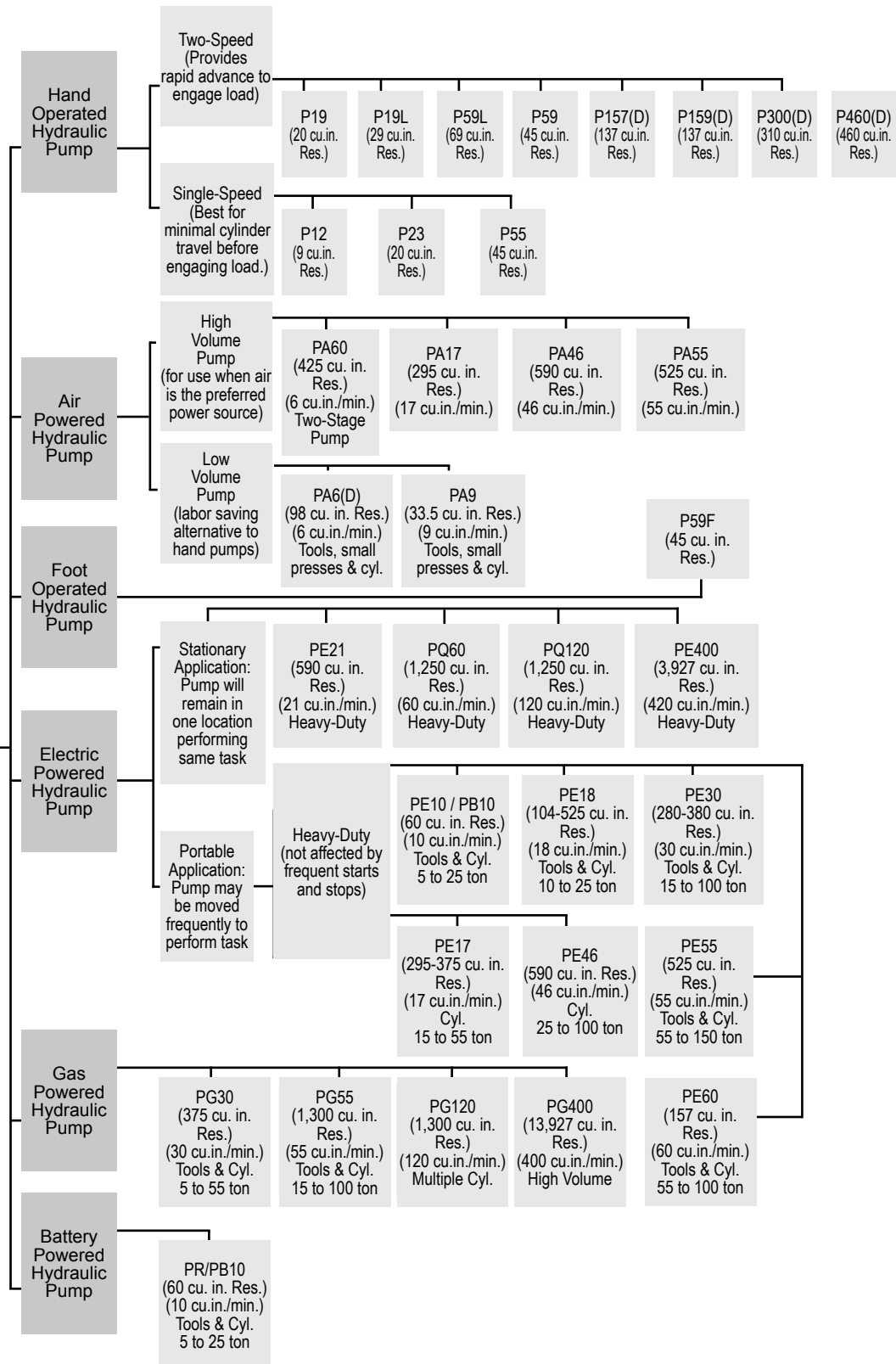

Model Shown:

P55, P12, P23

Pumps

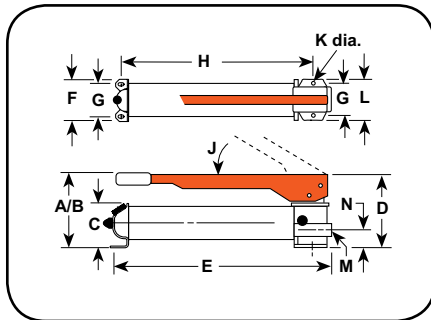

Features

STEEL HAND PUMPS BEST SUITED FOR MRO APPLICATIONS.

- All metal construction won't burn through in welding environments.
- Formed metal handle provides rigidity, and reduces operator fatigue with grip.
- Convenient fill port enables pumps to be filled in a horizontal or vertical position, excluding P12.
- Fill cap seal acts as safety valve preventing over-pressurizing of reservoir.
- Large valve knob gives added control for slowly metering loads down.



Pump Protection System

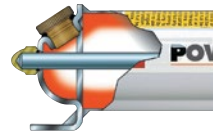

Power Team hand pumps, with the angled fill port, have a built in "relief valve" protection system. This system is designed to protect over-pressurization of the reservoir from sudden back pressure. This system also works as a seal to prevent oil leaks only fill to bottom of threads.



Foot Pump Conversion Kit



For Use With:	Kit Order No.	Wt. (lbs.)
P55, P59	FK59	6.0

Technical Dimensions

Order No.	A	B	C	D	E	F	G	H	J	K	L	M	N
	(in.)	(in.)	(in.)	(in.)	(in.)	(in.)	(in.)	(in.)	(deg.)	(in.)	(in.)	(in.)	(in.)
P12	4.00	13.00	2.06	4.00	13.50	3.38	2.19	11.50	45.00	0.19	3.38	3/8 NPTF	1.13
P19	5.50	14.63	2.88	4.56	13.69	4.00	3.25	11.06	53°	5/16	4.00	3/8 NPTF	1.41
P23*	6.25	13.00	3.50	5.56	13.63	4.25	3.25	10.31	38.00	0.19	4.75	3/8 NPTF	1.63
P55	6.50	21.00	3.50	5.56	23.00	4.25	3.25	19.75	38.00	0.19	4.75	3/8 NPTF	1.63

*The P23 pump maximum pressure is 3000 psi only.

For Use With	Speed	Order No.	Volume per Stroke		Max. Pressure		Handle Effort	Reservoir		Oil Port	Prod. Wt.
			LP	HP	LP	HP		Oil Cap.	Usable Oil Cap.		
			(cu. in)	(cu. in)	(psi)	(psi)		(cu. in.)	(cu. in.)		
Single-Acting Cylinders	1	P12	—	0.069	—	10,000	75	12.00	9.00	3/8 NPTF	5.70
	2	P19	0.305	0.076	325	10,000	99	24.40	20.00	3/8 NPTF	6.60
	1	P23	—	0.160	—	3,000	70	23.80	20.30	3/8 NPTF	12.00
	1	P55	—	0.160	—	10,000	145	55.00	45.00	3/8 NPTF	15.80

LP = Low Pressure

HP = High Pressure

Model Shown:

P19L, P59L, P59L-1500, P59L-1500G

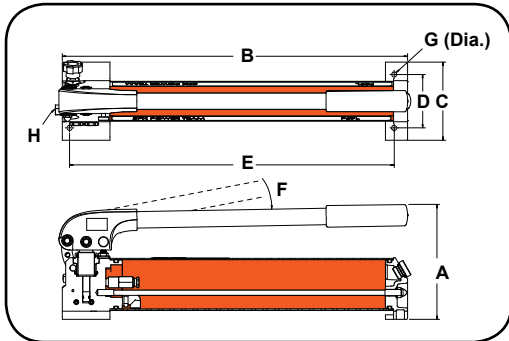

Technical Dimensions

Order No.	A	B	C	D	E	F	G	H
	(in.)	(in.)	(in.)	(in.)	(in.)	(deg.)	(in.)	(in.)
P19L	5.50	13.69	4.13	3.25	11.06	40°	5/16	3/8 NPTF
P59L	7.00	21.00	5.00	3.25	19.75	50°	5/16	3/8 NPTF
P59L-1500	7.17	21.91	5.47	3.25	19.75	47°	5/16	9/16-18 UNF
P59L-1500G*	7.17	21.91	5.47	3.25	19.75	47°	5/16	9/16-18 UNF

Ordering Information

For Use With	Speed	Order No.	Volume per Stroke		Max. Pressure		Handle Effort	Reservoir		Oil Port	Prod. Wt.
			LP	HP	LP	HP		Oil Cap.	Usable Oil Cap.		
			(cu. in)	(cu. in)	(psi)	(psi)		(cu. in.)	(cu. in.)		
Single-Acting Cylinders	2	P19L	0.250	0.050	850	10,000	78	29.00	27.00	3/8 NPTF	5.10
	2	P59L	0.720	0.150	850	10,000	104	69.00	66.00	3/8 NPTF	8.90
	2	P59L-1500	0.68	0.05	300	21,750	72	67.1	44.5	3/4 - 16 UNF	10.4
	2	P59L-1500G*	0.68	0.05	300	21,750	72	67.1	44.5	3/4 - 16 UNF	14.4

* Equipped with a skid plate and a digital gauge.

LP = Low Pressure

HP = High Pressure

CAUTION: P59L-1500 pumps are not recommended for use with 10,000 psi tools.

Features

PUMP AUTOMATICALLY SHIFTS INTO THE HIGH PRESSURE LIFT STAGE UPON CONTACT WITH THE LOAD.

- Two-speed reduces handle strokes so you work faster and easier.
- More usable oil volume allows for use with larger or longer stroke cylinders.
- True unloading valve provides more efficiency and lower handle force.
- Link design reduces handle effort by 40%.
- Durable aluminum reservoir, manifold, and end cap.
- Ergonomic non-slip handle grip provides more comfort.
- Spring loaded handle lock incorporated into handle.
- Aluminum design reduces weight.

The P59L hand pump is able to quickly advance the cylinder to the load with it's two speed operation.



Model Shown:
P300, P157, P159D, P460

Pumps



Features

HEAVY-DUTY STEEL HAND PUMPS HOLD UP TO THE MOST DEMANDING APPLICATIONS.

- Rugged all metal construction for strength and durability that won't burn through in welding environments.
- Heavy-duty, formed metal handle provides rigidity, and reduces operator fatigue with grip.
- Convenient oil fill ports.
- Fill cap seal acts as safety valve to prevent over-pressurizing of reservoir.
- Relief valve inboard of check valve prevents loads from drifting down.
- Large valve knob gives added control for slowly metering loads down.

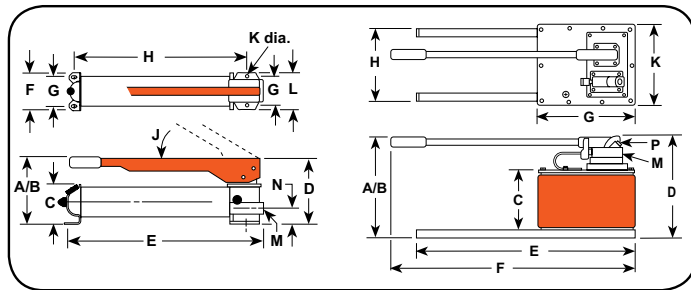

Foot Pump Conversion Kit



For Use With:	Kit Order No.	Wt. (lbs.)
P157, P159, P300, P300D	FK159B	6.00

Technical Dimensions

Order No.	A	B	C	D	E	F	G	H	J	K	L	M	N	P
	(in.)	(in.)	(in.)	(in.)	(in.)	(in.)	(in.)	(in.)	(deg.)	(in.)	(in.)	(in.)	(in.)	(in.)
P157 / P159	7.75	20.50	4.88	6.88	22.75	3.88	3.00	19.75	39	0.31	3.75	3/8 NPTF	2.25	—
P300	8.25	21.00	4.50	6.88	22.63	8.50	7.50	20.72	39	0.31	3.75	3/8 NPTF	2.25	—
P460	11.13	31.00	6.75	11.38	24.00	29.25	11.00	9.00	80	9.50	—	3/8 NPTF	—	1/4 NPTF

Ordering Information

For Use With	Speed	Order No.	Volume per Stroke		Max. Pressure		Handle Effort	Reservoir		Oil Port	Prod. Wt.
			LP	HP	LP	HP		Oil Cap.	Usable Oil Cap.		
			(cu. in.)	(cu. in.)	(psi)	(psi)		(cu. in.)	(cu. in.)		
Single-Acting Cylinders	2	P157	0.65	0.160	1,400	10,000	140	152	137	3/8 NPTF	26.70
	2	P159	2.60	0.160	325	10,000	140	152	137	3/8 NPTF	26.20
	2	P300	2.60	0.160	325	10,000	140	1.5 gal.	310	3/8 NPTF	55.30
	2	P460	7.35	0.294	325	10,000	90	2.5 gal.	460	3/8 NPTF	54.90
Double-Acting Cylinders*	2	P157D	0.65	0.160	1,400	10,000	140	152	137	3/8 NPTF	28.80
	2	P159D	2.60	0.160	325	10,000	140	152	137	3/8 NPTF	27.90
	2	P300D	2.60	0.160	325	10,000	140	1.5 gal.	310	3/8 NPTF	57.00
	2	P460D	7.35	0.294	325	10,000	90	2.5 gal.	460	3/8 NPTF	57.90

LP = Low Pressure

HP = High Pressure

* Pump includes 4-Way Valve

Model Shown:
RPS1006, RPS203H



Features

PRECISION-MATCHED CYLINDER AND PUMP SET FOR WIDE RANGE OF APPLICATIONS.

- Four styles of cylinders to choose from.
- Sets feature single or two-speed hydraulic hand pumps.
- Cylinders of various tonnages with long, medium or short stroke.
- Includes necessary fittings, couplers and 6 foot hose.

Pumps



OPTIONAL: STORAGE BOX



Storage box for hydraulic cylinder and pump sets. Rugged industrial strength material, strong as steel, never needs painting, won't rust, dent or chip. Weatherproof lid is self sealing and lockable. Molded-in handles, water-tight, one piece bottom and side construction. Strong enough to stand on. Note: Actual product may differ from photo.

Order No.	Dimensions	Wt. (lbs.)
350722	35" L x 14" H x 13.5" W	23.00

Ordering Information

Style of Cylinder	Cyl. Cap.	Stroke	Order No.	Re-tracted Height	Handle Strokes Required to Fully Extend Cylinders	Cylinder No.	Pump No.	Hose No.	Coupler No.	Pump Speed	Prod. Wt.
	(tons.)	(in.)		(in.)							(lbs.)
"C" Series	5	5.25	RPS55	8.50	75	C55C	P12	9756	9798	Single	12.00
	10	2.13	RPS102**	4.75	32	C102C	P55	9756	9798	Single	26.00
	10	6.13	RPS106**	9.75	93	C106C	P55	9756	9798	Single	32.10
	10	10.13	RPS1010**	13.75	154	C1010C	P55	9756	9798	Single	35.60
	15	4.13	RPS154**	7.88	81	C154C	P55	9756	9798	Single	29.00
	15	6.13	RPS156**	10.69	118	C156C	P55	9756	9798	Single	34.00
	25	6.25	RPS256**	10.75	219	C256C	P55	9756	9798	Single	42.70
	25	14.25	RPS2514**	18.75	285*	C2514C	P159	9756	9798	Two	62.70
	55	6.25	RPS556**	11.13	268*	C556C	P159	9756	9798	Two	82.70
	100	6.63	RPS1006	13.25	428*	C1006C	P460	9756	9798	Two	128.70
"Shorty"	30	2.44	RPS302**	4.63	61*	RSS302	P59	9756	9798	Two	40.00
	50	2.38	RPS552**	5.00	89*	RSS502	P59	9756	9798	Two	50.00
	100	2.25	RPS1002**	5.50	172*	RSS1002	P59	9756	9798	Two	81.00
"Center-Hole"	20	3.00	RPS203H**	6.06	80	RH203	P55	9756	9798	Single	40.50
Alum.	55	6.13	RPS556A**	10.75	262*	RA556	P159	9756	9798	Two	47.00

* Based on 50% of the stroke being made at low-pressure and 50% of the strokes at high pressure.

** Add suffix "B" (example: RPS102B, RPS203HB, etc.) to order set with optional storage box shown above.

Model Shown:

PA6, PA6M-1, PA6-2

Pumps



Features

COMPACT, LIGHTWEIGHT AND PORTABLE. SINGLE-SPEED PUMPS DESIGNED TO DRIVE SINGLE-ACTING CYLINDERS.

- The power unit of choice for major manufacturers of auto body, frame straighteners and other shop equipment.
- Operate at 40-100 psi shop air pressure at the pump.
- Quiet operation that is suitable for indoor applications, 85 dBA at 10,000 psi.
- Serviceable pump motor is not a “throw away” providing economical repair.
- Permanently vented reservoir cap.
- Internal relief valve protects circuit components, air inlet filter protects motor.



Typical Set-Up

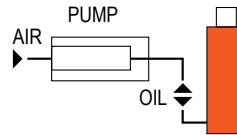

Hook-up for single-acting cylinders

▶ **PA6 is the perfect choice for driving this nut splitter in this heavy truck shop.**

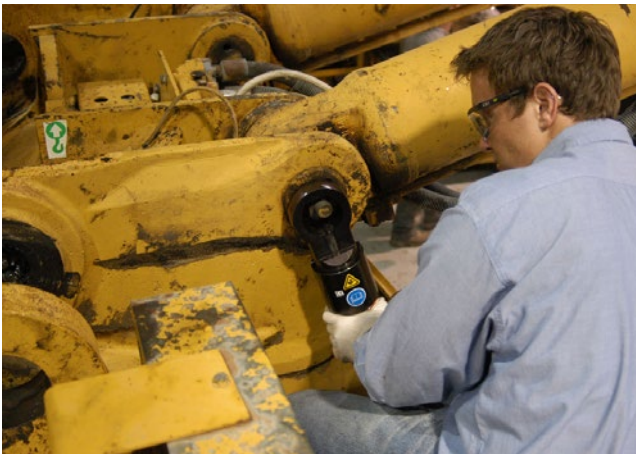

▶ **Performance Specifications**

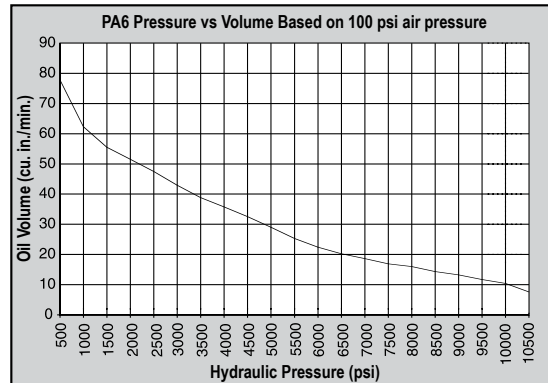

Two Point Lifting System Example



Pumps

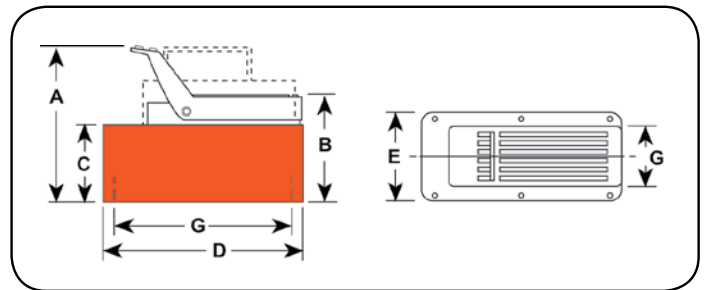

Technical Dimensions

Order No.	A (in.)	B (in.)	C (in.)	D (in.)	E (in.)	G (in.)
PA6	7.75	5.88	4.38	9.50	5.00	4 x 9.00
PA6A	7.75	5.88	4.38	9.50	5.00	4 x 9.00
PA6AM	7.75	5.88	4.38	9.50	5.00	4 x 9.00
PA6M	7.75	5.88	4.38	9.50	5.00	4 x 9.00
PA6R	7.75	5.88	4.38	9.50	5.00	4 x 9.00
PA6RM	7.75	5.88	4.38	9.50	5.00	4 x 9.00
PA6M-1	7.88	6.00	4.38	12.63	7.38	—
PA6-2	10.25	8.00	7.00	11.50	9.50	5 1/8 x 7.13
PA6M-2	10.00	7.75	6.75	11.50	9.50	8 x 10.00

Ordering Information

Description	Order No.	Air Supply Req'd (psi)	Reservoir		Oil Port (in.)	Prod. Wt. (lbs.)
			Oil Cap. (cu. in.)	Usable Oil Cap. (cu. in.)		
Base model pump with high density polyethylene reservoir.	PA6	40-120	105	98	3/8 NPTF	14.00
PA6 pump with externally adjustable relief valve and polyethylene reservoir	PA6A	40-120	105	98	3/8 NPTF	15.00
PA6 pump with externally adjustable relief valve and metal reservoir.	PA6AM	40-120	105	98	3/8 NPTF	17.00
PA6 pump with metal reservoir.	PA6M	40-120	105	98	3/8 NPTF	18.00
PA6 pump with 12 foot remote control and polyethylene reservoir	PA6R	40-120	105	98	3/8 NPTF	20.58
PA6 pump with 12 foot remote control and metal reservoir.	PA6RM	40-120	105	98	3/8 NPTF	21.58
PA6 pump with 1 gallon metal reservoir.	PA6M-1	40-120	1 gal.	185	3/8 NPTF	23.70
PA6 pump with 2 gallon high density polyethylene reservoir.	PA6-2	40-120	2 gal.	454	3/8 NPTF	24.50
PA6 pump with 2.5 gallon metal reservoir.	PA6M-2	40-120	2.5 gal.	570	3/8 NPTF	32.10

Model Shown:
PA6D

Pumps



Features

COMPACT, LIGHTWEIGHT AND PORTABLE SINGLE-SPEED PUMP FOR DRIVING DOUBLE-ACTING CYLINDERS.

- Operate at 40-100 psi shop air pressure at the pump.
- Internal relief valve protects circuit components while the air inlet filter protects motor.
- Serviceable pump allows for economical repairs.
- Permanently vented reservoir cap.
- 85 dBA at 10,000 psi for all PA6 pumps.



Typical Set-Up

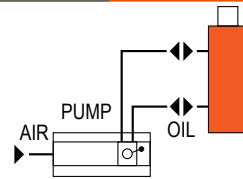

Hook-up for double-acting cylinders

▶ PA6D pump, 9052 analog and 25 ton cylinder used in a test fixture.



Performance Specifications

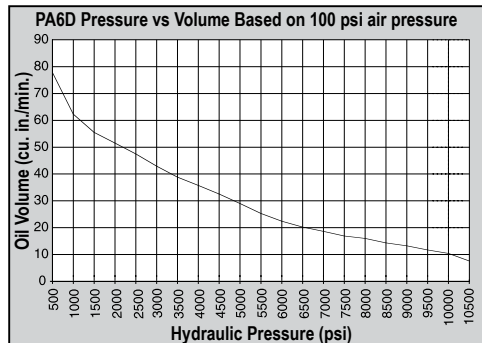

Model Shown:

PA6D2, PA6DM-1



Pumps

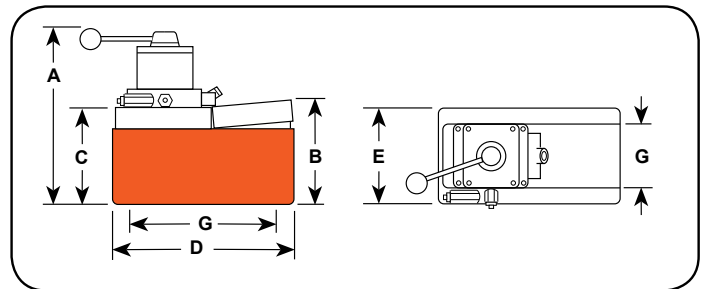

Technical Dimensions

Order No.	A	B	C	D	E	G
	(in.)	(in.)	(in.)	(in.)	(in.)	(in.)
PA6D	10.38	5.88	4.38	9.50	5.00	4 x 9.00
PA6DM	10.38	5.88	4.38	9.50	5.00	4 x 9.00
PA6DM-1	11.00	5.75	4.38	12.63	7.38	n/a
PA6D2	12.75	8.00	7.00	11.31	9.25	5 1/8 x 7.13
PA6DM-2	12.50	7.75	6.75	11.50	9.50	8 x 10.00

Technical Specifications

Description	Order No.	Valve No.	Air Supply Req'd (psi)	Reservoir		Oil Port (in.)	Prod. Wt. (lbs.)
				Oil Cap. (cu. in.)	Usable Oil Cap. (cu. in.)		
Base model pump with high density polyethylene reservoir.	PA6D	9504 3-way/4-way	40-120	105	98	3/8 NPTF	18.40
PA6D pump with metal reservoir.	PA6DM	9504 3-way/4-way	40-120	105	98	3/8 NPTF	20.40
PA6D pump with 1 gallon metal reservoir.	PA6DM-1	9504 3-way/4-way	40-120	1 gal.	185	3/8 NPTF	28.10
PA6D pump with 2 gallon high density polyethylene reservoir.	PA6D2	9504 3-way/4-way	40-120	2 gal.	454	3/8 NPTF	28.60
PA6D pump with 2.5 gallon metal reservoir.	PA6DM-2	9504 3-way/4-way	40-120	2.5 gal.	570	3/8 NPTF	36.20

Model Shown:

PA9 Foot Control, PA9H Hand Control

Pumps



>Features

IDEAL FOR POWERING SINGLE-ACTING CYLINDERS AND PORTABLE HYDRAULIC TOOLS.

- Easier to operate than a hand pump, giving you the speed you need at an affordable price.
- Serviceable pump allows for economical repairs.
- Unique bladder design for all-position operation and storage.
- Operates on 40-120 psi shop air, at 20 cfm.
- Hard-coat anodized aluminum housing.
- Oil filler with integral safety relief minimizes chance of damage to reservoir bladder if overfilling occurs.



Typical Set-Up

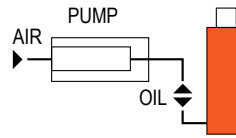

Hook-up for single-acting cylinders

▶ **PA9H Hand Control Pump used in a straightening press.**



▶ **Performance Specifications**

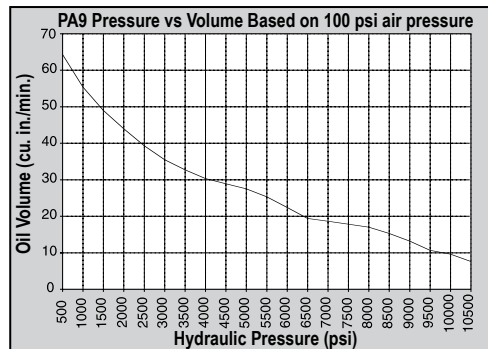

PA9 Foot Control

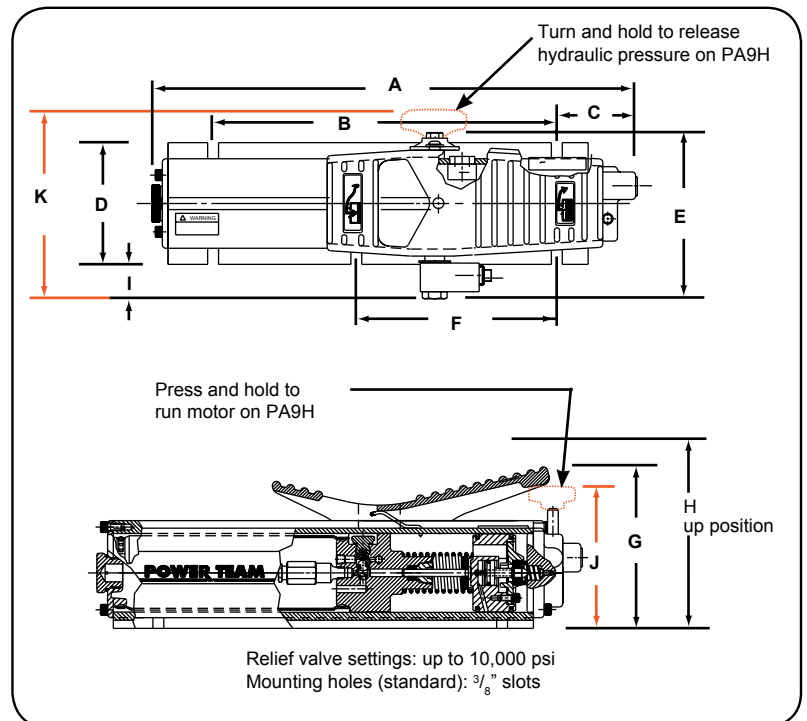

Technical Dimensions

Order No.	A	B	C	D	E	F	G	H	I	J	K
	(in.)	(in.)	(in.)	(in.)	(in.)	(in.)	(in.)	(in.)	(in.)	(in.)	(in.)
PA9	16.94	12.00	2.81	4.25	5.31	7.00	5.83	7.00	1.13	—	—
PA9H	16.94	12.00	2.81	4.25	—	7.00	—	7.00	1.13	4.81	6.69

Ordering Information

For Use With Cyl. Type	Order No.	Air Supply Req'd (psi)	Reservoir		Oil Port (in.)	Max. Pressure Output (psi)	Prod. Wt. (lbs.)
			Oil Cap. (cu. in.)	Usable Oil Cap. (cu. in.)			
Single-Acting	PA9	40-120	35.00	33.50	3/8 NPTF	10,000	15.00
Single-Acting	PA9H	40-120	35.00	33.50	3/8 NPTF	10,000	15.00

Model Shown:

PA64

Pumps



Features

TWO-SPEED PUMP FOR RAPID OIL DELIVERY AT LOW PRESSURE QUICKLY ADVANCES CYLINDER OR TOOL.

- Equipped with air pressure regulator, air filter and lubricator.
- Serviceable air motor for economical repair.
- Internal relief valve protects circuit components.
- Permanently vented reservoir cap.



Typical Set-Up

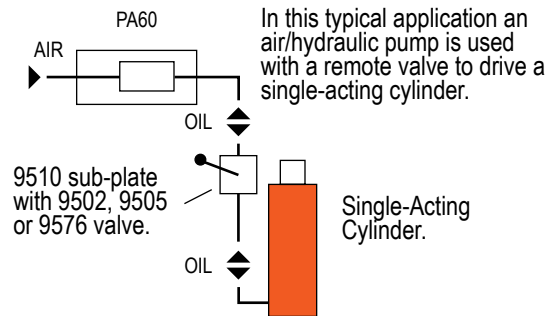

▶ The PA60 used in a work-holding environment



▶ **Performance Specifications**

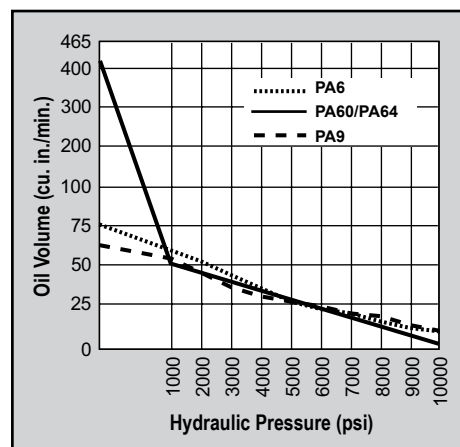

Model Shown:

PA60



Pumps

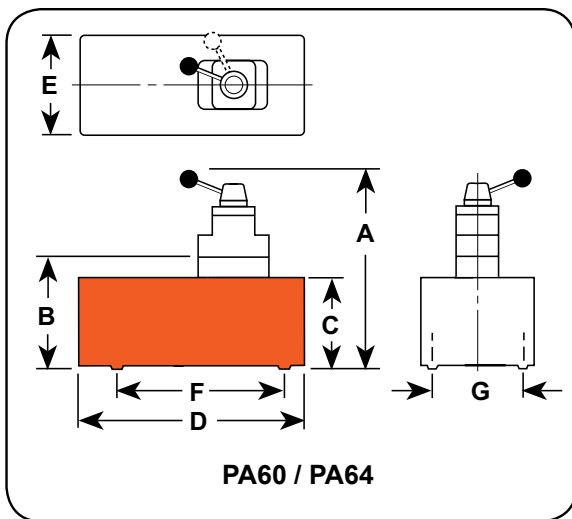

► Technical Dimensions

Order No.	A	B	C	D	E	F	G	Max. Pressure Output (psi)	Oil Del. (cu. in./min. @) *				
									0	100	1,000	5,000	10,000
									(psi)	(psi)	(psi)	(psi)	(psi)
PA60	—	9.44	8.13	14.25	9.63	7.13	5.13	10,000	360	350	50	12	6
PA64	14.25	—	8.13	14.25	9.63	7.13	5.13	10,000	390	350	50	12	6

* Typical delivery. Actual flow will vary with field conditions.

► Technical Specifications

Description	Order No.	Valve No.	Valve Function	Air Supply Req'd (psi)	Reservoir		Oil Port (in.)	Prod. Wt. (lbs.)
					Oil Cap. (cu. in.)	Usable Oil Cap. (cu. in.)		
For use with remote valves.	PA60	9626 Manifold	—	40-120	2.00	425.00	3/8 NPTF	54.00
For use with single or double-acting cylinders	PA64	9507 3/4-Way	Advanced Hold Return	40-120	2.00	425.00	3/8 NPTF	56.00

Model Shown:

PA50D, PA50M, PA50R2

Pumps



▶ The PA50 used in a work-holding environment



▶ Features

SINGLE-SPEED, LOW PRESSURE (3,200 PSI) OUTPUT PUMPS.

- Serviceable air motor for economical repair.
- Air inlet filter protects air motor.
- Filter in outlet port protects against contaminated systems.
- Assorted reservoirs to suit your application's requirements.

▶ Performance Specifications

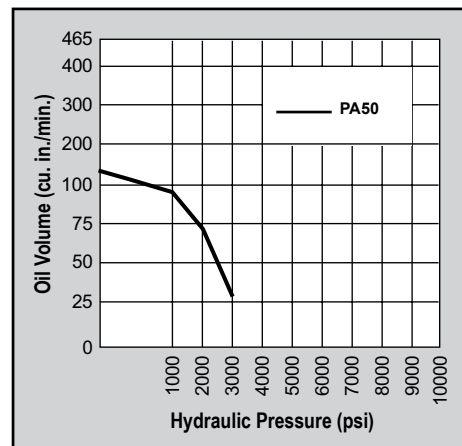

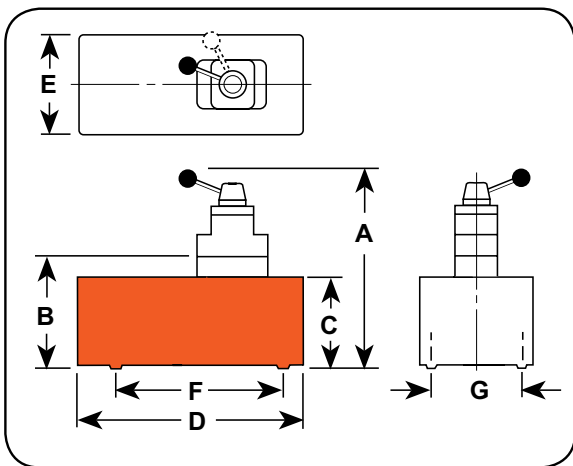

Hydraulic Hoses



Heavy-duty and thermo plastic hydraulic hoses to meet your requirements and safety factor.

Refer to the accessories section for details.



Analog Gauges



Improve your system visibility and safety by adding an inline hydraulic gauge to your circuit.

9440 (2.5 in.), 9052 (4 in.), and 9089 (6 in.)

Technical Dimensions

Order No.	A	B	C	D	E	F	G	Max. Pressure Output (psi)	Oil Del. (cu. in./min. @) *			
									0	100	1,000	3,200
									(psi)	(psi)	(psi)	(psi)
PA50, PA50R	7.75	5.88	4.38	9.50	5.00	—	4 x 9.00	3,200	128	110	88	28
PA50R2	10.25	8.00	7.00	11.50	9.50	—	5 1/8 x 7.13	3,200	128	110	88	28
PA50D	10.38	5.88	4.38	9.50	5.00	9.00	4.00	3,200	128	110	88	28

* Typical delivery. Actual flow will vary with field conditions.

Ordering Information

For Use With Cylinder Type	Description	Order No.	Valve No.	Air Supply Req'd (psi)	Reservoir		Oil Port (in.)	Prod. Wt. (lbs.)
					Oil Cap. (cu. in.)	Usable Oil Cap. (cu. in.)		
Single-Acting	Base model pump with high density polyethylene reservoir.	PA50	—	40-120	105	98	3/8 NPTF	14.20
Single-Acting	PA50 pump with 12 foot remote control and polyethylene reservoir.	PA50R	—	40-120	105	98	3/8 NPTF	18.50
Single-Acting	PA50R with 2 gallon polyethylene reservoir.	PA50R2	—	40-120	2 gal.	454	3/8 NPTF	28.50
Single and Double-Acting	PA50 pump with valve and polyethylene reservoir.	PA50D	9504 3-way / 4-way	40-120	105	98	3/8 NPTF	18.40

Notes: Air inlet port 1/4" NPTF. Requires 20 cfm at 100 psi shop air pressure at the pump to achieve 3,200 psi.

Model Shown:

PA172, PA174

Pumps



Features

ROTARY-STYLE AIR MOTOR. USE WHERE AIR IS THE PREFERRED SOURCE OF ENERGY.

- Two-speed operation for high speed cylinder advance.
- Durable two gallon thermoplastic reservoir. (Metal reservoir conversion kits are available.)
- Air motor capable of starting under full load.

▶ The PA17 used with a flange spreader



▶ Performance Specifications

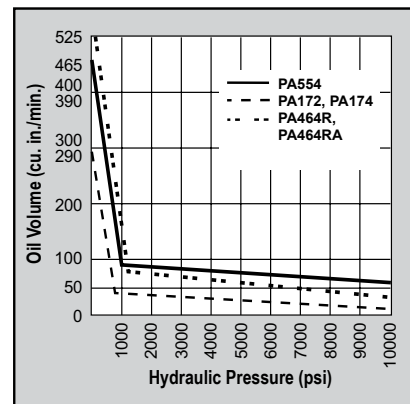



Hydraulic Hoses

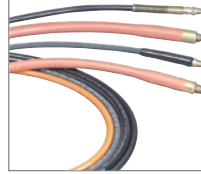

Heavy-duty and thermo plastic hydraulic hoses to meet your requirements and safety factor.

Refer to the accessories section for details.



Hydraulic Fluids



For dependable performance of all your hydraulic pumps and cylinders. Power Team specialty blended oils contains foam suppressant additives and has a high viscosity index. Refer to the Accessories section for complete details



Learn More - About Hydraulic Safety Insight



Looking for great safety suggestions? Visit our Resource Section to get a better understanding of hydraulic and mechanical safety insights on what to look for when working around hydraulics

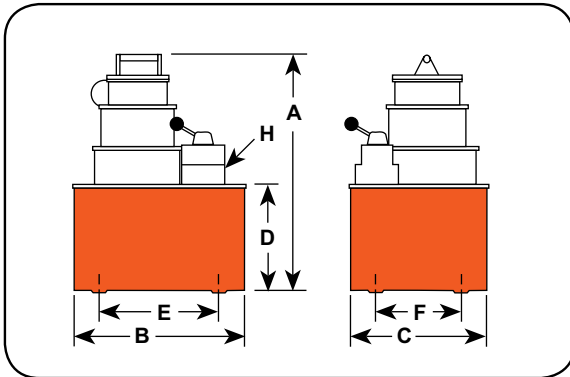

Technical Dimensions

Order No.	A	B	C	D	E	F	H	Max. Pressure Output	Oil Del. (cu. in./min. @) *				
									0	100	1,000	5,000	10,000
									(psi)	(psi)	(psi)	(psi)	(psi)
PA172	14.13	11.38	9.25	7.00	7.13	5.13	3/8 NPTF	10,000	290	240	24	23	17
PA174	14.13	11.38	9.25	7.00	7.13	5.13	3/8 NPTF	10,000	290	240	24	23	17

* Typical delivery. Actual flow will vary with field conditions.

Ordering Information

For Use With Cylinder Type	Description	Order No.	Valve No.	Valve Function	Air Supply Req'd (psi)	Reservoir		Prod. Wt. (lbs.)
						Oil Cap. (cu. in.)	Usable Oil Cap. (cu. in.)	
Single-Acting	Base model pump with 2 gallon thermoplastic reservoir.	PA172	9517, 2-way	Advance Return*	40-120	2	295	40.00
Single and Double-Acting	PA172 pump with 2 gallon thermoplastic reservoir, 9500 valve for use with single or double-acting cylinders	PA174	9500, 4-way	Advance Hold Return*	40-120	2	295	41.00

* Holds pressure in advance position when valve motor is shut-off or in return position with motor running. Pump will build pressure when motor is shut-off and oil returns to reservoir.

Notes: Requires 40 cfm at 100 psi shop air pressure at the pump. 85/90 dBA at 10,000 psi.

Model Shown:

PA462, PA464R, PA554

Pumps



▶ **PA554 pump and RH2008 Center Hole cylinder used to tension cables.**



Features

ROTARY-STYLE AIR MOTOR. USE WHERE AIR IS THE PREFERRED SOURCE OF ENERGY.

- 3 hp motor starting under full load.
- Two-speed operation for rapid cylinder advance.
- Models available with full remote control over advance and return, (except PA554).
- Tandem center valve holds the load when pump is shut-off.



Torque Wrench Pumps



For Torque Wrench Pump Configurations, refer to the Tools Section.

▶ **Performance Specifications**

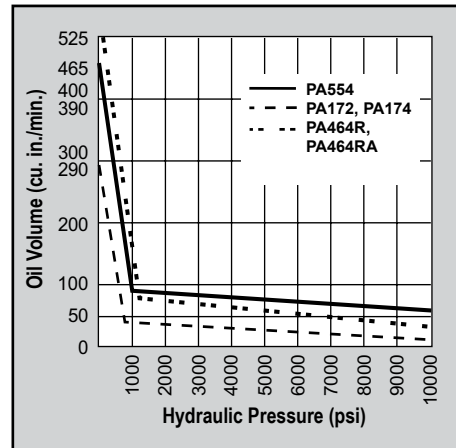

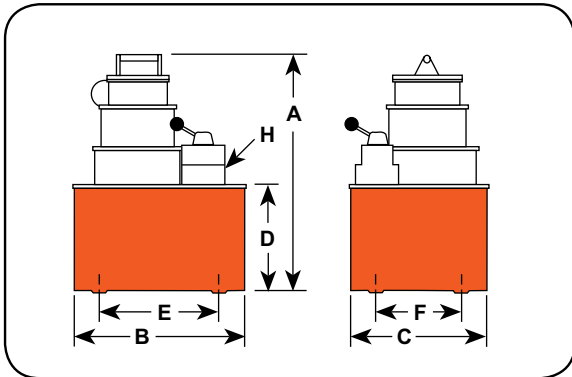

Analog Gauges



Improve your system visibility and safety by adding an inline hydraulic gauge to your circuit.

9440 (2.5 in.), 9052 (4 in.), and 9089 (6 in.)

Technical Dimensions

Order No.	A (in.)	B (in.)	C (in.)	D (in.)	E (in.)	F (in.)	H (in.)	Max. Pressure Output (psi)	Oil Del. (cu. in./min. @) *				
									0	100	1,000	5,000	10,000
									(psi)	(psi)	(psi)	(psi)	(psi)
PA462	15.00	11.50	9.50	7.00	10.00	8.00	3/8 NPTF	10,000	465	450	53	51	46
PA464	15.00	11.50	9.50	7.00	10.00	8.00	3/8 NPTF	10,000	465	450	53	51	46
PA464R	15.00	11.50	9.50	7.00	10.00	8.00	3/8 NPTF	10,000	465	450	53	51	46
PA464RA	15.00	11.50	9.50	7.00	10.00	8.00	3/8 NPTF	10,000	465	450	53	51	46
PA554	19.00	11.50	9.50	7.00	10.00	8.00	3/8 NPTF	10,000	465	450	80	70	55

* Typical delivery. Actual flow will vary with field conditions.

Note: Reservoir has four 1/2" - 20 mounting holes.

Ordering Information

For Use With Cylinder Type	Description	Order No.	Valve Number	Valve Function	Air Supply Req'd (psi)	Reservoir		Prod. Wt. (lbs.)
						Oil Cap. (cu. in.)	Usable Oil Cap. (cu. in.)	
Single-Acting	Base model pump with 2.5 gallon steel reservoir.	PA462	9584, 2-way	Advance/ Hold/ Return	40-120	2.5	590	60.00
Single and Double-Acting	PA462 pump with 9500 valve capable of running 2 single-acting cylinders or one double-acting cylinder.	PA464	9500, 4-way	Advance/ Hold/ Return*	40-120	2.5	590	61.00
Single and Double-Acting	PA462 pump with air actuated valve for full remote control over advance and return. Includes 12 ft. remote control.	PA464R†	9594, 4-way	Advance/ Hold/ Return	40-120	2.5	590	78.00
Single and Double-Acting	PA464R pump with automatic dump feature. Includes 25 ft. remote control.	PA464RA**†	9594, 4-way	Advance/ Hold/ Return*	40-120	2.5	590	79.00
Single and Double-Acting	High-performance pump with 2.5 gallon steel reservoir.	PA554	9500, 4-way	Advance/ Hold/ Return*	40-120	2.5	525	72.00

* Holds when motor is shut-off and valve is in "advance" position.

Notes: Requires 50 cfm at 80 psi shop air pressure at the pump. 85/90 dBA at 10,000 psi.

** Not to be used for lifting.

† The PA464RA has an "automatic dump" feature. Pressure is not held when operator releases "advance" or "return" button. PA464R will "hold" only in the "advance" position with the motor shut-off.

Model Shown:

PUA70U, PMA190U

Pumps



>Features

PROVIDES INFINITELY VARIABLE CAPACITY AND DISCHARGE PRESSURE

- Suitable for continuous and start/stop applications.
- Pumps oil, water, and other fluids.
- Stainless steel pump and check valves standard.
- Maintains pressure with minimal power consumption (Non-load holding).
- Usable in hazardous areas (per ATEX II, CAT. 2 GDcT5).
- Quiet operation
- Simple to install and maintain with a compact, rugged design.
- Only 15 psi air pressure required to start pump.
- Requires flooded inlet. vertical mount.
- Can operate on gases other than air.

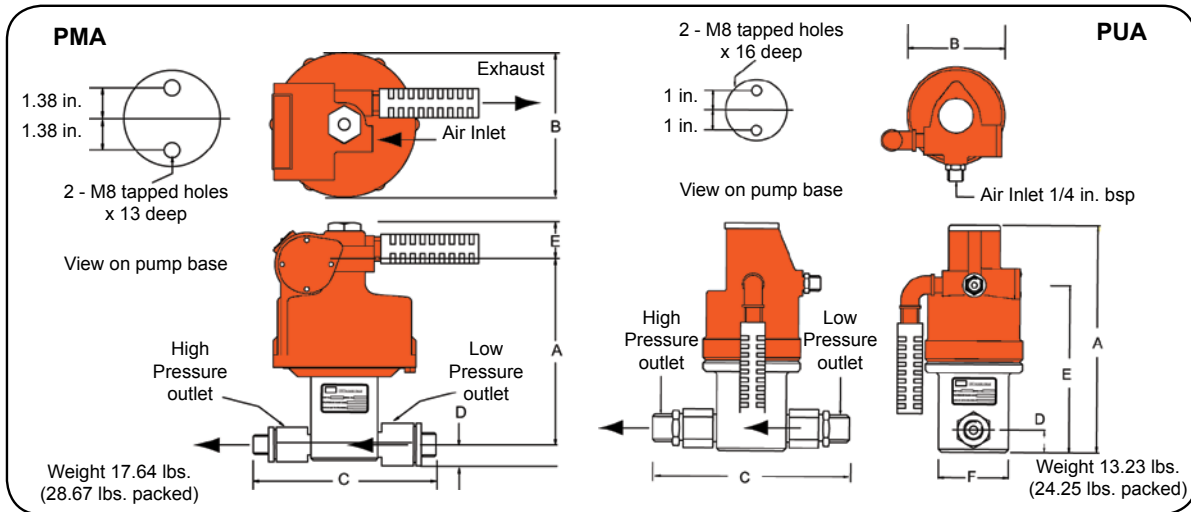

Technical Dimensions

Order No.	RAM/ Dia. (in.)	A (in.)	B (in.)	C (in.)	D (in.)	E (in.)	F (in.)
PUA26U	1.25	9.17	4.02	6.61	0.87	6.69	2.87
PUA70U	0.75	8.74	4.02	6.61	0.87	6.22	2.87
PUA157U	0.50	8.74	4.02	6.61	0.87	6.22	2.87
PUA275U	0.38	8.74	4.02	6.61	0.87	6.22	2.87
PUA430U	0.31	8.74	4.02	6.61	0.87	6.22	2.87
PUA655U	0.25	8.74	4.02	6.61	0.87	6.22	2.87
PUA982U	0.20	8.74	4.02	6.61	0.87	6.22	2.87
PMA27U	3.00	8.66	7.01	9.06	1.50	1.89	-
PMA60U	2.00	8.27	7.01	9.06	1.50	1.89	-
PMA90U	1.63	8.27	7.01	9.06	1.50	1.89	-

Order No.	RAM/ Dia. (in.)	A (in.)	B (in.)	C (in.)	D (in.)	E (in.)	F (in.)
PMA130U	1.38	7.99	7.01	7.68	0.87	1.89	-
PMA190U	1.13	7.99	7.01	7.68	0.87	1.89	-
PMA240U	1.00	7.99	7.01	7.68	0.87	1.89	-
PMA370U	0.81	7.99	7.01	7.01	0.87	1.89	-
PMA520U	0.69	7.99	7.01	7.01	0.87	1.89	-
PMA770U	0.56	7.99	7.01	7.01	0.87	1.89	-
PMA980U	0.50	7.99	7.01	7.01	0.87	1.89	-
PMA1740U	0.38	7.99	7.01	10.08	0.87	1.89	-
PMA2410U	0.31	7.99	7.01	10.08	0.87	1.89	-

Ordering Information

NPT Fittings	Ratio	Outlet Pres.	Outlet Per Cycle	Max. Flow at 0 Press.	Inlet	Outlet
	1:	(psi)	(cu. in.)	(cu. in./min.)	(NPT)	(NPT)
PUA26U	4.3	380	1.680	850	1/2" NPT	1/2" NPT
PUA70U	11.9	1,010	0.607	305	1/2" NPT	1/2" NPT
PUA157U	26.7	2,280	0.270	146	1/2" NPT	1/2" NPT
PUA275U	47.5	3,990	0.151	85	1/2" NPT	1/2" NPT
PUA430U	68.4	6,230	0.105	55	1/2" NPT	1/2" NPT
PUA655U	107.0	9,500	0.670	36	1/2" NPT	1/2" NPT
PUA982U	163.8	14,250	0.044	24	1/2" NPT	1/2" NPT
PMA27U	4.0	390	9.720	2260	1" NPT	3/4" NPT
PMA60U	9.0	870	4.320	1400	1" NPT	3/4" NPT
PMA90U	13.6	1,300	2.850	915	1" NPT	3/4" NPT

NPT Fittings	Ratio	Outlet Pres.	Outlet Per Cycle	Max. Flow at 0 Press.	Inlet	Outlet
	1:	(psi)	(cu. in.)	(cu. in./min.)	(NPT)	(NPT)
PMA130U	19.0	1,880	2.040	670	3/4" NPT	1/2" NPT
PMA190U	28.4	2,750	1.370	455	3/4" NPT	1/2" NPT
PMA240U	36.0	3,480	1.080	354	3/4" NPT	1/2" NPT
PMA370U	54.5	5,360	0.710	230	1/2" NPT	1/2" NPT
PMA520U	76.5	7,540	0.510	170	1/2" NPT	1/2" NPT
PMA770U	113.0	11,160	0.340	110	1/2" NPT	1/2" NPT
PMA980U	145.0	14,210	0.270	91	1/2" NPT	1/2" NPT
PMA1740U	256.0	25,230	0.150	51	1/2" NPT	3/8" HP
PMA2410U	368.0	35,000	0.104	35	1/2" NPT	3/8" HP

PUA:

Pumps

PUA - 4.3:1

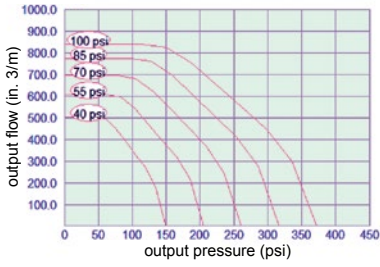

PUA - 11.9:1

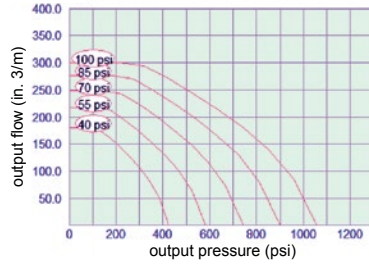

PUA - 26.7:1

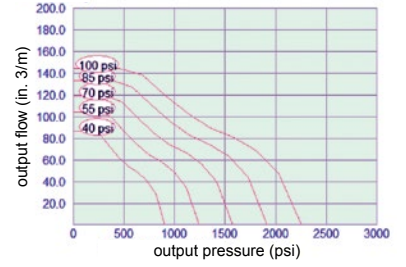

PUA - 47.5:1

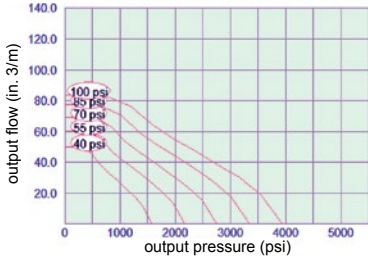

PUA - 68.4:1

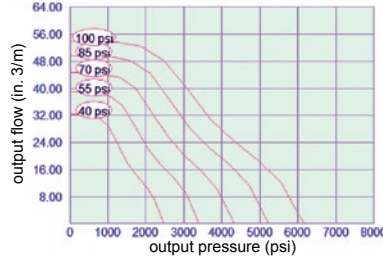

PUA - 107:1

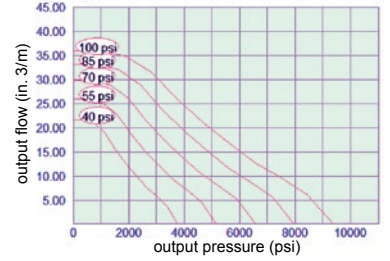

PUA - 163.8:1

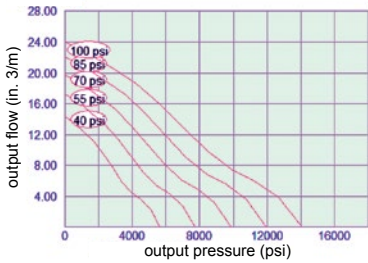

Model Shown:

PUA70U, PMA190U



PMA:

PMA - 4:1

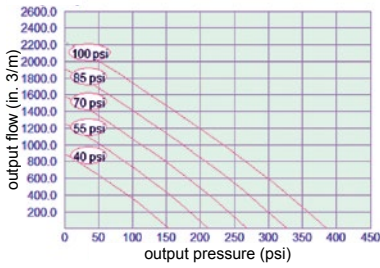

PMA - 9:1

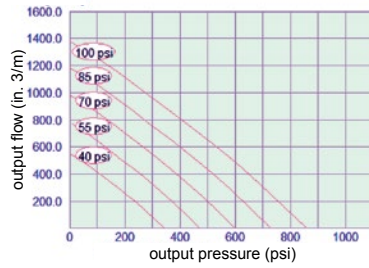

PMA - 13.6:1

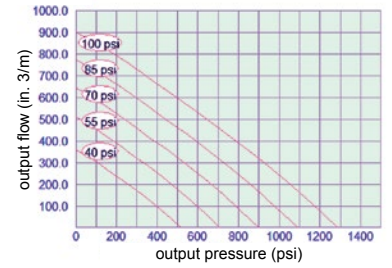

PMA - 19:1

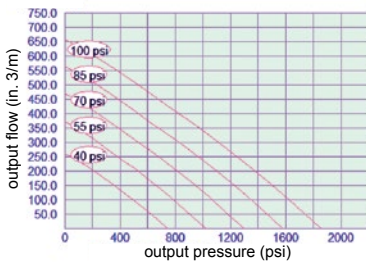

PMA - 28.4:1

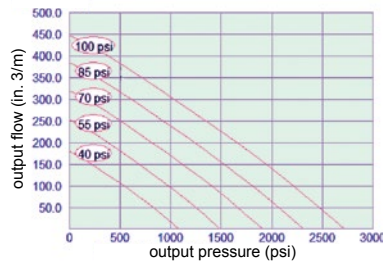

PMA - 36:1

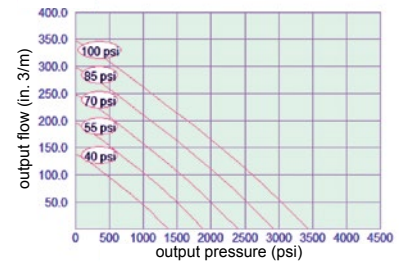

PMA - 54.5:1

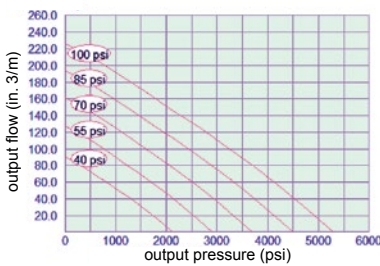

PMA - 76.5:1

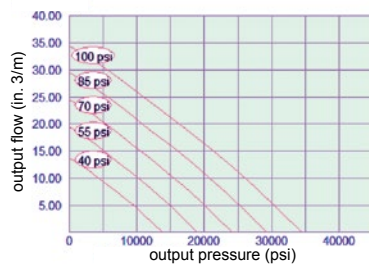

PMA - 113:1

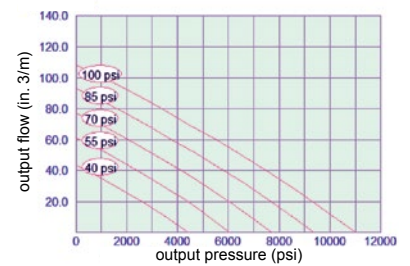

PMA - 145:1

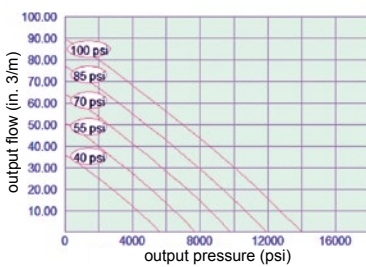

PMA - 256:1

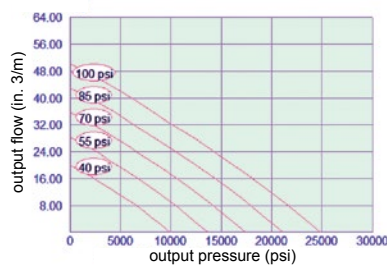

PMA - 368:1

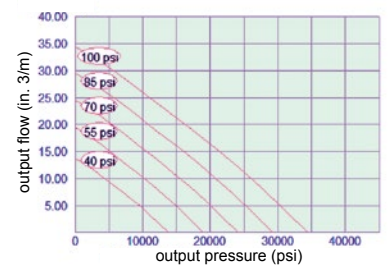

Model Shown:

PB102-1, PB102P-1

Pumps



Features

COMPACT, PORTABLE, CORDLESS HYDRAULIC PUMP FOR MRO APPLICATIONS.

- Compact, Li-ion 18VDC, 9.0 Ah battery-powered pump provides extended run-time.
- Two-stage, high-pressure hydraulic pump offers quick tool advancement in the first stage.
- Extremely compact, lightweight with an ergonomic handle grip and transport strap to ease portability.
- Self-contained, rubber bladder reservoir allows pump usage in most positions with an impressive capacity of 70 cu. in. usable.
- Quiet, smooth-running, serviceable brushed 18VDC motor.
- High-impact, fiberglass reinforced shroud protects your investment in the most demanding and harsh applications.
- Interchangeable valve configuration accommodates a vast array of applications.
- CSA rated for intermittent duty, CE compliant.

Ordering Information

Order No.	Description	Refer to Note	Tool Type	Valve Type	Valve Function	Remote Control
PB102-1	18VDC, 1/4 hp Power Pump, S/A, 2-Way w/Auto Dump	(1)	SA	2-Way/ Auto. Dump (9561)	Advance / Return (Auto)	Optional
PB102P-1	18VDC Power Pump, S/A, 2-Way w/Auto Dump	(1)	SA	2-Way/ Auto. Dump (9561)	Advance / Return (Auto)	Included, Pendant with 10 ft. cord
PB102R-1	18VDC Power Pump, S/A, 2-Way w/Auto Dump and Pressure Regulator	(1), (3)	SA	2-Way/ Auto. Dump / Pressure Regulator (9561, 9560)	Advance / Return (Auto) / Pressure Adjustment 1-10K	Optional
PB102A-1	18VDC Power Pump, S/A, Auto Dump	(2)	SA	Auto. Dump (9562)	Advance / Return	Optional
PB104-1	18VDC Power Pump, S/A, 4-Way	(4)	DA	4-Way (9563)	Advance / Hold / Return	Optional
PB102-0	18VDC, 1/4 hp Power Pump, S/A, 2-Way w/Auto Dump	(1)	SA	2-Way/ Auto. Dump (9561)	Advance / Return (Auto)	Optional
PB102P-0	18VDC Power Pump, S/A, 2-Way w/Auto Dump	(1)	SA	2-Way/ Auto. Dump (9561)	Advance / Return (Auto)	Included, Pendant with 10 ft. cord
PB102R-0	18VDC Power Pump, S/A, 2-Way w/Auto Dump and Pressure Regulator	(1), (3)	SA	2-Way/ Auto. Dump / Pressure Regulator (9561, 9560)	Advance / Return (Auto) / Pressure Adjustment 1-10K	Optional
PB102A-0	18VDC Power Pump, S/A, Auto Dump	(2)	SA	Auto. Dump (9562)	Advance / Return	Optional
PB104-0	18VDC Power Pump, S/A, 4-Way	(4)	DA	4-Way (9563)	Advance / Hold / Return	Optional

(1) 2-Way Auto Dump Function: Flapper handle in "hold" position will allow the tool to advance and maintain pressure when the motor is shut-off, flapper handle must be switched back to retract and dump pressure. Flapper handle is set to "return" position, power on will advance tool and power-off will retract tool and dump pressure.

(2) Auto Dump Function: Power on - tool advances, and power-off - tool returns, releasing pressure to tank.

(3) Using the external knob, the pressure regulator valve allows the operator to externally adjust the pressure on demand, ranges from 500 - 10,000 psi.

(4) Four-way valve direction is controlled by the handle lever. Three position; Advance, hold, retract.

SA = Single-Acting DA = Double-Acting

▶ Technical Dimensions

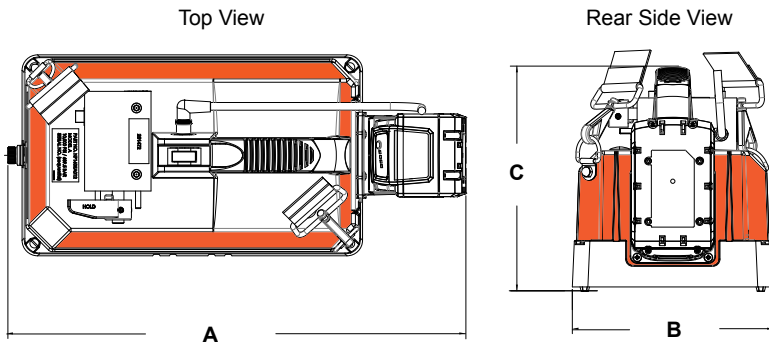

▶ Hardware Included



Turnkey, 10,000 PSI (690 bar) hydraulic power pump powered by an 18VDC Li-Ion battery, ships with hydraulic oil.



Transport shoulder strap with clips installed on shroud for quick fastening or removal.



One 18VDC Li-Ion 9.0 Ah Battery, additional batteries can be purchased separately.



18VDC battery charger available in 115VAC or 230VAC for certain models, excludes all -0 models

Flow @ Stages (cu. in.)	Usable Oil Capacity (cu. in.)	Battery Included	Charger (w/plug style)	Dimension			Prod. Weight (lbs.)	Order No.
				A	B	C		
				Length (in.)	Width (in.)	Height (in.)		
1st Stage: 200 @ 200 psi 2nd Stage: 6 @ 10,000 psi	70	18VDC L-ion 9.0 Ah	115VAC M18 Charger 	12.81	7.56	8.45	24.00	PB102-1
				12.81	7.56	8.45	26.00	PB102P-1
				12.81	7.56	9.52	25.00	PB102R-1
				12.81	7.56	7.56	24.00	PB102A-1
				12.81	7.56	10.20	25.00	PB104-1
1st Stage: 200 @ 200 psi 2nd Stage: 6 @ 10,000 psi	70	18VDC L-ion 9.0 Ah	No charger is included	12.81	7.56	8.45	24.00	PB102-0
				12.81	7.56	8.45	26.00	PB102P-0
				12.81	7.56	9.52	25.00	PB102R-0
				12.81	7.56	7.56	24.00	PB102A-0
				12.81	7.56	10.20	25.00	PB104-0

Optional Remotes

These remotes are equipped with connectors to enable the operator to "plug and play" the connection quickly. The wiring is configured to allow the operator to use the power switch on the pump or operate remotely once connected.

Hand Pendant
Order # 3000989

Foot Pendant
Order # 3000975

Model Shown:
PE104, PR104

Pumps



Features

HIGH-PERFORMANCE IN A COMPACT PACKAGE. ELECTRIC AND BATTERY POWERED MODELS FOR POWERING TOOLS AND CYLINDERS UP TO 25 TON.

- Portable power source for hydraulic cylinders and tools.
- Permanent magnet motor starts easily under load, even with reduced voltage conditions.
- Battery-operated models have 8 foot power cord with alligator clips to connect to any 12VDC battery.
- Optional rechargeable battery pack with shoulder strap for maximum portability.
- Pump typically delivers 15 minutes of continuous operation at 10,000 psi on a single battery.
- Pump can be operated in any position.
- 24VDC hand and foot switches available for all AC powered models.
- High-impact housing with flame-retardant construction.
- Base mounting holes for fixed installations.
- CSA rated for intermittent duty.

Performance Specifications

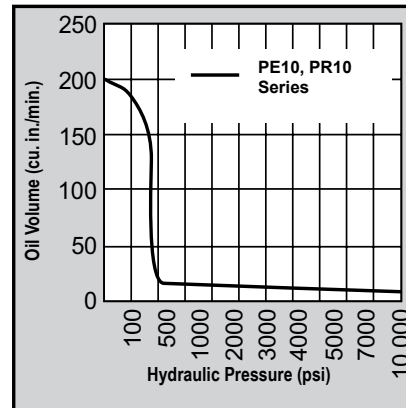
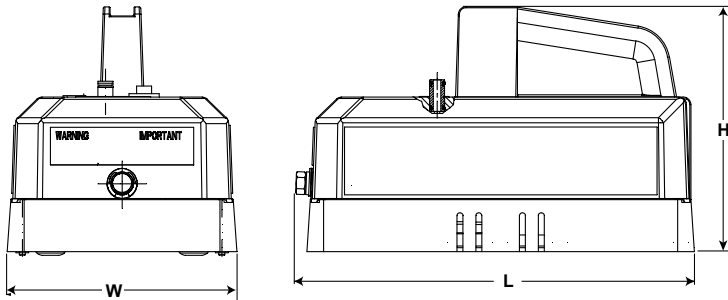

Technical Dimensions

Order No.	Max. Pressure Output (psi)	dBA at Idle and 10,000 (psi)	Oil Del. (cu. in./min. @)		Overall Dimensions			Prod. Wt. with Oil (lbs.)
			0-40 (psi)	10,000 (psi)	Length (in.)	Width (in.)	Height (in.)	
PE10 Series	10,000	68-74 *	120	10	13.00	7.75	8.00	20.00
PR10 Series								

* Measured at 3 ft. distance, all sides.

▶ Accessories



BP212VQ – Optional 12VDC battery pack. Includes sealed lead acid battery, 115VAC charger, 4 ft. cord, carrying case and shoulder strap. Wt., 17.7 lbs.

RB12V – Battery only.

BP12INT – Battery with cord and carrying case. Wt., 11.1 lbs.

RC12V – Replacement 4 ft. battery cord only. Wt., 0.5 lbs.

NOTE: PR10 rechargeable model is equipped with 8 ft. cord with alligator clips. Order optional battery pack (No. BP212VQ) or use with any 12VDC battery.

NOTE: Amp draw at 10,000 psi – 6 amp at 115VAC, 3 amp at 230VAC, and 35 amp at 12VDC.



BC212 – Battery charger for U.S.A. Wt., 6.6 lbs.

BC212EUR – Battery charger for Europe. Wt., 6.6 lbs.

25017 – Remote hand control with 10 ft. cord. Wt., 0.8 lb.



9560 – Pressure regulator. Adjustable from 1,000 to 10,000 psi. All mounting hardware included. Wt., 3.0 lbs.



251660 – Foot switch with 10 ft. cord. Single pole, double throw, 15 amp @ 125-250VAC. Wt., 1.0 lb.

▶ The Quarter Horse pump has a maximum operating pressure of 10,000 psi, which handles a wide variety of hand-held hydraulic tools.



▶ Ordering Information

Order No.	For Use With Cylinder Type	Description	Valve Type	Valve No.	Valve Function	Control Switch	Motor	Reservoir Usable Oil Cap. (cu. in.)
PE102	Single-Acting	1/4 hp motor. Bladder type reservoir, 110VAC power required.	2-Way/ Auto Dump	9561	Advance Return (Auto.)*	Rocker Type off, Momentary on	1/4 hp, 110/115VAC 50/60 Hz, Single-Phase	60
PE102A	Single-Acting	1/4 hp motor. Bladder type reservoir, 110VAC power required, automatic dump valve.	Auto. Dump	9562	Advance Return**	Rocker Type off, Momentary on	1/4 hp, 110/115VAC 50/60 Hz, Single-Phase	60
PE102-220	Single-Acting	1/4 hp motor. Bladder type reservoir, 220VAC power required.	2-Way/ Auto. Dump	9561	Advance Return (Auto.)*	Rocker Type off, Momentary on	1/4 hp, 110/115VAC 50/60 Hz, Single-Phase	60
PE102A-220	Single-Acting	1/4 hp motor. Bladder type reservoir, 220VAC power required, automatic dump valve.	Auto. Dump	9562	Advance Return**	Rocker Type off, Momentary on	1/4 hp, 220/230VAC 50/60 Hz, Single-Phase	60
PR102	Single-Acting	1/4 hp motor. Bladder type reservoir, 12VDC power required.	2-Way/ Auto. Dump	9561	Advance Return (Auto.)*	Rocker Type off, Momentary on	1/4 hp, 12VDC†	60
PR102A	Single-Acting	1/4 hp motor. Bladder type reservoir, 12VDC power required, automatic dump valve.	Auto. Dump	9562	Advance Return**	Rocker Type off, Momentary on	1/4 hp, 12VDC†	60
PE104	Single-Acting, Double-Acting	Base model pump has 4-way valve for operating double-acting systems. 110VAC power required.	4-Way	9563	Advance Hold Return	Rocker Type off, Momentary on	1/4 hp, 110/115VAC 50/60 Hz, Single-Phase	60
PE104-220	Single-Acting, Double-Acting	PE104 pump has 4-way valve for operating double-acting systems. 220VAC power required.	4-Way	9563	Advance Hold Return	Rocker Type off, Momentary on	1/4 hp, 220/230VAC 50/60 Hz, Single-Phase	60
PR104	Single-Acting, Double-Acting	PE104 pump has 4-way valve for operating double-acting systems. 12VDC power required.	4-Way	9563	Advance Hold Return	Rocker Type off, Momentary on	1/4 hp, 12VDC†	60

* Advance position holds pressure with motor shut-off. Return position advances cylinder with motor running and returns cylinder with motor shut-off.

** Cylinder advances with motor running and automatically returns with motor shut-off.
† Comes with an 8 ft. alligator clip cord for 12VDC use.

Model Shown:

PE172, PE172SM, PE174

Pumps



Features

FOR MAINTENANCE AND CONSTRUCTION APPLICATIONS.

- For use with single or double-acting cylinders at operating pressure up to 10,000 psi.
- Equipped with 1/2 hp, 3,450 rpm, single-phase, thermal protected induction motor; 10 ft. remote control cord (PE172S has 25 ft. cord)
- Low amperage draw; small generators and low amperage circuits can be use as power source.
- Extremely quiet noise level (67-81 dBA).
- Starts under full load for intermittent duty.



Hydraulic Hoses

Heavy-duty and thermo plastic hydraulic hoses to meet your requirements and safety factor.

Refer to the accessories section for details.

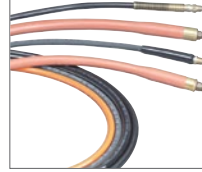

Performance Specifications

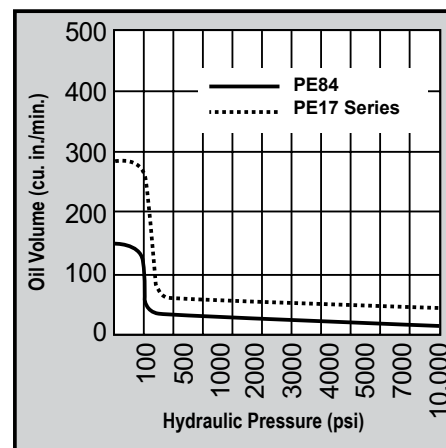

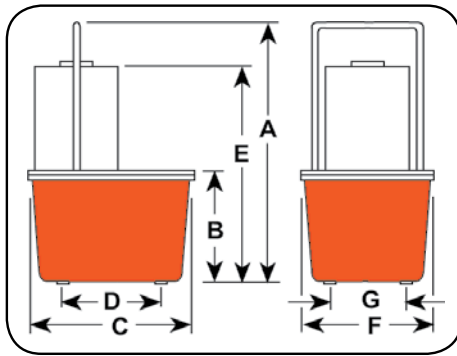

Technical Dimensions

Order No.	A	B	C	D	E	F	G	Max. Pressure Output (psi)	rpm	dBA at Idle and 10,000 (psi)	Amp Draw 115 V - at 10,000 (psi)	Oil Del. (cu. in./min. @)				Prod. Wt. with Oil (lbs.)
	(in.)	(in.)	(in.)	(in.)	(in.)	(in.)	(in.)					(in.)	0 (psi)	100 (psi)	5,000 (psi)	
PE17 Series	18.50	7.00	11.38	7.13	14.88	9.25	5.13	10,000	3,450	67/81*	10	290	190	20	16	45.00
PE17M Series	18.13	6.63	11.50	—	14.50	9.50	—	10,000	3,450	67/81*	10	290	190	20	16	53.00
PE84 Series	18.50	7.00	11.38	7.13	15.38	9.25	5.13	10,000	1,750	67/81*	10	145	120	12	8	47.00

* PE84 is the same as the PE174, except has continuous duty with 2 gallon thermoplastic reservoir and features 1,750 RPM

Ordering Information

For Use With Cylinder Type	Description	Order No.	Valve Type	Valve No.	Valve Function	Control Switch ††	Motor	Reservoir Usable Oil Cap. (cu. in.)
Single-Acting	1/2 hp pump with 2 gallon thermoplastic reservoir.	PE172	2-Way	9517	Advance Return (Auto†)	Remote Motor Control (10 ft.) on/off	1/2 hp, 110/115VAC* 50/60 Hz, Single-Phase	295
Single-Acting	1/2 hp pump with 2.5 gallon aluminum reservoir.	PE172M	2-Way	9517	Advance Return (Auto†)	Remote Motor Control (10 ft.) on/off	1/2 hp, 110/115VAC* 50/60 Hz, Single-Phase	375
Single-Acting	1/2 hp pump with 2 gallon thermoplastic reservoir, solenoid-operated valve.	PE172S	3-Way	9579	Advance Hold Return	Remote Motor & Valve (25 ft.)	1/2 hp, 110/115VAC 50/60 Hz, Single-Phase	295
Single-Acting	1/2 hp pump with 2 gallon aluminum reservoir, solenoid-operated valve.	PE172SM	3-Way	9579	Advance Hold Return	Remote Motor & Valve (25 ft.)	1/2 hp, 110/115VAC 50/60 Hz, Single-Phase	375
Single-Acting	Best suited for crimping, punching, pressing. Not for lifting. Thermoplastic reservoir.	PE172A [∞]	Auto./Dump Manifold	45554	Advance Return	Remote Motor Control (10 ft.) on/off	1/2 hp, 110/115VAC 50/60 Hz, Single-Phase	295
Single-Acting	Best suited for crimping, punching, pressing. Not for lifting. Aluminum reservoir.	PE172AM [∞]	Auto./Dump Manifold	45554	Advance Return	Remote Motor Control (10 ft.) on/off	1/2 hp, 110/115VAC* 50/60 Hz, Single-Phase	375
Single-Acting, Double-Acting	1/2 hp pump with 2 gallon thermoplastic reservoir, 9500 double-acting valve.	PE174	4-Way	9500	Advance Hold Return**	Remote Motor Control (10 ft.) on/off	1/2 hp, 110/115VAC* 50/60 Hz, Single-Phase	295
Single-Acting, Double-Acting	1/2 hp pump with 2 gallon aluminum reservoir, 9500 double-acting valve.	PE174M	4-Way	9500	Advance Hold Return**	Remote Motor Control (10 ft.) on/off	1/2 hp, 110/115VAC* 50/60 Hz, Single-Phase	375
Single- or Multi Double-Acting	1/2 hp pump, continuous duty with 2 gallon thermoplastic reservoir, 9500 double-acting valve.	PE84	4-Way	9500	Advance Hold Return**	Remote Motor Control (10 ft.) on/off	1/2 hp, 115VAC* 60 Hz, Single-Phase	295

* Available with 220VAC 50Hz motor (to order, place suffix "50-220" behind pump order number).

** Advance position holds pressure with motor shut-off.

† Advance position holds pressure with motor shut-off. Return position advances cylinder with motor running and returns cylinder with motor shut-off.

[∞] Not to be used for lifting.

‡ Some Power Team pumps are available in special configurations not listed in this catalog. For your special requirements please consult your local distributor or the Power Team factory.

†† The remote motor control switch on 220VAC 50Hz cycle PE17 series pumps is 24VDC.

NOTE: Usable oil is calculated with the oil fill at the recommended level of 1.50" below reservoir cover plate.

NOTE: Contact Factory for special 12VDC version for service vehicles

Model Shown:

PE182, PE183-2, PE183C

Pumps



Features

IDEAL FOR USE WITH SMALL HYDRAULIC POWER TOOLS.

- Vanguard Jr.® pumps provide two-speed high-performance in a light-weight, compact package.
- Gauge port provided on pump. Metal reservoir on all models.
- Equipped with a 1/2 hp, 115VAC, 60/50 Hz single-phase motor that starts under load, even at reduced voltage.
- Low amperage draw permits use with smaller generators and low amperage circuits.
- All pumps have a 10 foot remote control (PE183C has 25 foot remote control).
- Noise level of 85-90 dBA.
- CSA rated for intermittent duty.



For operating hydraulic crimping, cutting or other tools:

- **PE183C** - For crimping or pressing applications. Has special electrical circuitry to pulse/advance, hold at full pressure, build to a predetermined pressure, release and reset circuit. Features separate emergency return switch.
- **PE184C** - Allows operator to alternately operate a spring-return cutting and/or crimping tool without disconnecting either tool. Select port connection with manual 4-way valve, start pump with remote control hand switch and extend connected tool. When hand switch is switched to off, pump stops and automatic valve opens, allowing tool to return. In center (neutral) position, manual control valve holds tool in position at time valve is shifted.

Performance Specifications

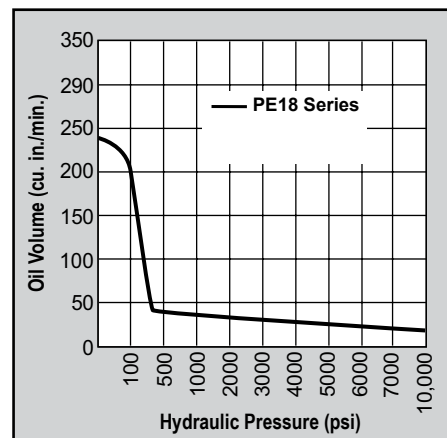

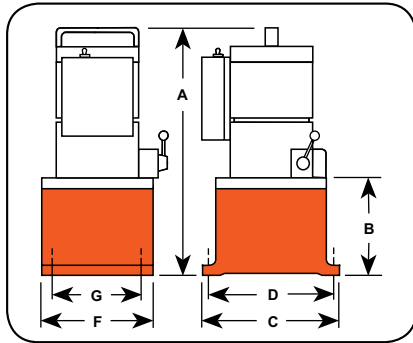

Technical Dimensions

Order No.	A (in.)	B (in.)	C (in.)	D (in.)	E (in.)	F (in.)	G (in.)	Max. Pressure Output (psi)	rpm	dBA at Idle and 10,000 (psi)	Amp Draw 115VAC at 10,000 (psi)	Oil Del. (cu. in./min. @) †				Prod. Wt. with Oil (lbs.)
												0 (psi)	100 (psi)	5,000 (psi)	10,000 (psi)	
PE182	16.00	4.75	8.00	7.13	6.00	5.13	10,000	12,000	85/90**	10.2 Amps	230	190	25	18	30.00	
PE183	16.00	4.75	8.00	7.13	6.00	5.13	10,000	12,000	85/90**	10.2 Amps	230	190	25	18	30.00	
PE183A	16.00	4.75	8.00	7.13	6.00	5.13	10,000	12,000	85/90**	10.2 Amps	230	190	25	18	30.00	
PE184	16.00	4.75	8.00	7.13	6.00	5.13	10,000	12,000	85/90**	10.2 Amps	230	190	25	18	30.00	
PE183-2*	18.50	7.25	11.50	10.00	9.50	8.00	10,000	12,000	85/90**	10.2 Amps	230	190	25	18	42.00	
PE184-2*	18.50	7.25	11.50	10.00	9.50	8.00	10,000	12,000	85/90**	10.2 Amps	230	190	25	18	42.00	
PE183C ††	16.00	4.75	8.00	7.13	6.00	5.13	10,000	12,000	85/90**	10.2 Amps	230	190	25	18	30.00	
PE184C ††	16.00	4.75	8.00	7.13	6.00	5.13	10,000	12,000	85/90**	10.2 Amps	230	190	25	18	30.00	

* 2.5 gal. reservoir.

** Measured at 3 ft. distance, all sides.

† Typical delivery. Actual flow will vary with field conditions.

†† Special application pumps for cutting, crimping or pressing.

Ordering Information

For Use With Cylinder Type	Description	Order No.	Valve Type	Valve Function	Control Switch	Motor	Reservoir Usable Oil Cap. (cu. in.)
Single-Acting	1/2 hp pump with 2-Way valve and 0.5 gallon reservoir.	PE182	2-Way	Advance Return†	Remote Motor Control (10 ft.) on/off	1/2 hp, 110/115VAC** 50/60 Hz, A.C., Single-Phase	104
Single-Acting	1/2 hp pump with 3-Way valve and 0.5 gallon reservoir.	PE183	3-Way	Advance Hold Return	Remote Motor Control (10 ft.) on/off	1/2 hp, 110/115VAC** 50/60 Hz, A.C., Single-Phase	104
Single-Acting	1/2 hp pump with 3-Way valve and 2 gallon reservoir.	PE183-2	3-Way	Advance Hold Return	Remote Control (10 ft.)	1/2 hp, 110/115VAC** 50/60 Hz, A.C., Single-Phase	525††
Single-Acting	1/2 hp pump with dump valve and 0.5 gallon reservoir.	PE183A∞	Auto./Dump Pump	Advance Return	Remote (10 ft.)	1/2 hp, 110/115VAC** 50/60 Hz, A.C., Single-Phase	104
Single-Acting	Special crimping pump.	PE183C∞	Special, for crimping only	Advance Hold Return†	Remote Motor Control (25 ft.) on/off	1/2 hp, 110/115VAC** 50/60 Hz, A.C., Single-Phase	104
Single-Acting, Double-Acting	1/2 hp pump for double-acting systems with 0.5 gallon reservoir.	PE184	4-Way	Advance Hold Return	Remote Motor Control (10 ft.) on/off	1/2 hp, 110/115VAC** 50/60 Hz, A.C., Single-Phase	104
Single-Acting, Double-Acting	1/2 hp pump for double-acting systems with 2 gallon reservoir.	PE184-2	4-Way	Advance Hold Return†	Remote Motor Control (10 ft.) on/off	1/2 hp, 110/115VAC** 50/60 Hz, A.C., Single-Phase	525††
Single-Acting, Double-Acting	Special crimping pump.	PE184C*	4-Way	Advance Return	Remote Control (10 ft.) on/off	1/2 hp, 110/115VAC** 50/60 Hz, A.C., Single-Phase	104

* Also for use with special single-acting cylinder applications.

** Available with 220VAC, 60/50 Hz motor (to order, place suffix "50-220" behind pump order number). Specify voltage when ordering.

† Holds when motor is shut-off and valve is in "advance" position.

†† Pumps supplied with 2 gallon oil (usable oil is 355 cu. in.), will hold 2.50 gallon when filled to within 1.50" below reservoir cover plate.

∞ Not to be used for lifting.

Model Shown:

PE213, PE214, PE214S

Pumps



Features

IDEAL FOR USE WITH SMALL MEDIUM HYDRAULIC POWER TOOLS.

- Totally enclosed, fan cooled induction motor: 1 hp, 1,725 rpm, 60 Hz, single-phase. Thermal overload protection.
- Remote control, with 10 foot cord is standard on pumps with solenoid valves. Manual valve pumps have "Stop", "Start" and "Run/Off/Pulse" switches.
- Pump controls are moisture and dust resistant.
- Motor drip cover with carrying handles and lifting lug.
- Low noise level of 70 dBA@10,000 psi.
- In the event of electrical interruption, pump shuts off and will not start up until operator presses the pump start button.
- Units with remote have a 24VAC control circuit that provides additional user/operator safety.
- CSA rated for intermittent duty.

- ▶ PE21 series pump and RD5513 cylinder used in a special press that produces pharmaceutical-grade extracts for herbal medicines.



Performance Specifications

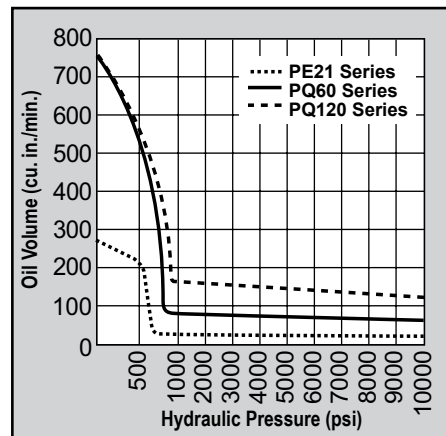



Learn More - About Hydraulic Safety Insight



Looking for great safety suggestions? Visit our Resource Section to get a better understanding of hydraulic and mechanical safety insights on what to look for when working around hydraulics.



Optional Cylinders

Power Team offers a wide variety of single-acting, double-acting, lock nut, pancake and center hole cylinders to meet your requirements.

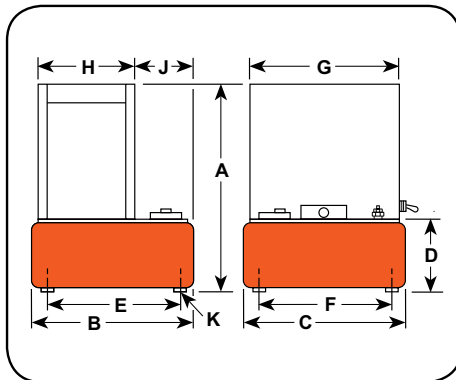

Technical Dimensions

Order No.	A	B	C	D	E	F	G	H	J	K**	Max. Pressure Output (psi)	rpm	dBA at Idle and 10,000 (psi)	Oil Del. (cu. in./min. @)				Prod. Wt. † with Oil (lbs.)
	(in.)	(in.)	(in.)	(in.)	(in.)	(in.)	(in.)	(in.)	(in.)	(in.)				100 (psi)	1000 (psi)	5,000 (psi)	10,000 (psi)	
PE21 Series	21.38	11.50	9.50	6.50	10.00	8.00	14.13	9.50	3.25	1/2-20 UNF	10,000	1,725	70*	270	29	27	22	98.00

** For 2" dia. swivel casters, order (4) No. 10494.

† Shipping weight with manual valve; add 14 lbs. for pump with solenoid valve.

Ordering Information

For Use With Cylinder Type	Description	Order No.	Valve Type	Valve No.	Valve Function	Max. Amp Draw @ 10,000 †† (psi)	Motor	Reservoir Usable Oil Cap. (cu. in.)
Single-Acting	1 hp pump with 2.5 gallon reservoir and manual valve.	PE213	3-Way	9520*	Advance Hold Return	115VAC -15 amps 230VAC -7.5 amps	1 hp, 115/230VAC 60 Hz, Single-Phase	590
Single-Acting	1 hp pump with 2.5 gallon reservoir and solenoid-operated remote valve.	PE213S	3-Way	9599†	Advance Hold Return	115VAC -15 amps 230VAC -7.5 amps	1 hp, 115/230VAC 60 Hz, Single-Phase	590
Double-Acting	1 hp pump with 2.5 gallon reservoir and manual valve.	PE214	4-Way	9506*	Advance Hold Return	115VAC -15 amps 230VAC -7.5 amps	1 hp, 115/230VAC 60 Hz, Single-Phase	590
Double-Acting	1 hp pump with 2.5 gallon reservoir and solenoid-operated remote valve.	PE214S	4-Way	9512†	Advance Hold Return	115VAC -15 amps 230VAC -7.5 amps	1 hp, 115/230VAC 60 Hz, Single-Phase	590

* Manual valve. Pump is equipped with RUN/OFF/PULSE switch for control of motor.

† Solenoid valve. Pump is equipped with a remote control switch with 10 ft. cord.

†† Pre-wired at factory for this voltage. PE21 series available in 230VAC 60Hz or 220VAC 50Hz. Please specify when ordering. Example: for 60Hz order PE213-230; for 50Hz order PE213-50-220.

NOTE: Some Power Team pumps are available in special configurations not listed in this catalog. For your special requirements please consult your local distributor or the Power Team Customer Service.

Model Shown:

PED253, PED254, PED254S

Pumps



Features

IDEAL FOR RUNNING MULTIPLE TOOLS OR CYLINDERS FROM ONE POWER UNIT. RECOMMENDED FOR CYLINDERS UP TO 75 TONS.

- Two-speed pumps have the same low pressure and high pressure flows from both valves.
- Flows and pressures of each pump are independent.
- Delivers 300 cu. in./min. of oil @ 100 psi and 25 cu. in./min. @ 10,000 psi from each pump.
- 1.5 hp, 110/115VAC, 60 Hz induction motor, 10 foot remote control and 5 gallon steel reservoir.
- Models available for operating single-acting or double-acting cylinders.
- Each power unit contains two separate pumps and two separate valves allowing operator to control multiple processes with one power unit.
- Both pumps on each power unit are equipped with an externally adjustable pressure relief valve.
- Not recommended for frequent starting and stopping.

▶ PED series pump and RD5513 cylinder used in a special press that produces pharmaceutical-grade extracts for herbal medicines.



Performance Specifications

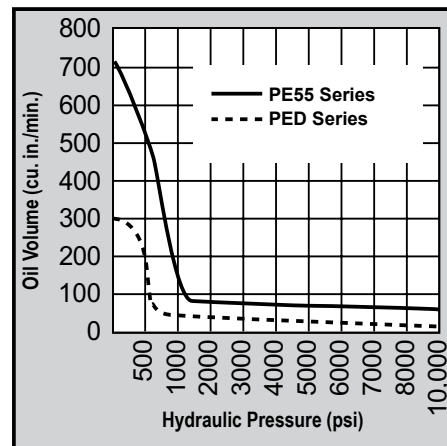

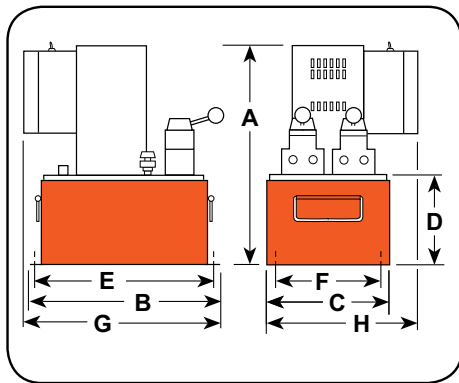

Technical Dimensions

Order No.	A	B	C	D	E	F	G	H	Max. Pressure Output (psi)	rpm	dBA at Idle and 10,000 (psi)	115VAC** Amp Draw at 10,000 (psi)	Oil Del. (cu. in./min. @)				Prod. Wt. with Oil (lbs.)
	(in.)	(in.)	(in.)	(in.)	(in.)	(in.)	(in.)	(in.)					100 (psi)	1000 (psi)	5,000 (psi)	10,000 (psi)	
PED Series	20.75	18.00	11.50	8.50	16.50	9.00	18.00	13.00	10,000	3,450	87/85*	22	300	40	35	25	170.00

** Amp draw at 10,000 psi, 230VAC 50/60 Hz is 15 Amps.

Ordering Information

For Use With Cylinder Type	Description	Order No.	Valve Type	Valve No.	Valve Function	Control Switch	Motor	Reservoir Usable Oil Cap. (cu. in.)
Single-Acting	1.5 hp pump with 5 gallon reservoir. Valve has "Posi-Check" feature.	PED253	3-Way	9520	Advance Return	Remote Motor	1-1/2 hp, 115/230VAC 60 Hz, Single-Phase	1,000
Double-Acting	1.5 hp pump with 5 gallon reservoir. Valve has "Posi-Check" feature.	PED254	4-Way	9506	Advance Hold Return	Remote Motor	1-1/2 hp, 115/230VAC 60 Hz, Single-Phase	1,000
Double-Acting	1.5 hp pump with 5 gallon reservoir. Solenoid-operated remote valve.	PED254S	4-Way	9513	Advance Hold Return	Remote Control	1-1/2 hp, 115/230VAC 60 Hz, Single-Phase	1,000

NOTE: All remotes are 10 ft. long.

4 Port Control Manifold



For independent multiple-cylinder operation, feature needle valves for precise manual control. Designed for remote-mounted applications.

Ordering Information: 9644

Hydraulic Fluids



For dependable performance of all your hydraulic pumps and cylinders. Power Team specialty blended oils contains foam suppressant additives and has a high viscosity index. Refer to the Accessories section for complete details

Model Shown:
PE302S, PE302

Pumps



Features

IDEAL FOR MAINTENANCE AND CONSTRUCTION APPLICATIONS

- Deliver a powerful punch to operate single-acting or double-acting cylinders.
- Integral roll cage protects pump from abuse.
- 1 hp, single-phase, permanent magnet motor.
- High-performance-to-weight ratio.
- Starts under full load even when voltage is reduced to 50% of nominal rating.
- Quiet operation: 82 dBA @ 10,000 psi and 87 dBA @ 0 psi.
- Remote controls and/or solenoid valves feature 24VAC controls.
- CSA rated for intermittent duty.



PE30TWP



For Torque Wrench Pump Configurations, refer to the Tools Section.

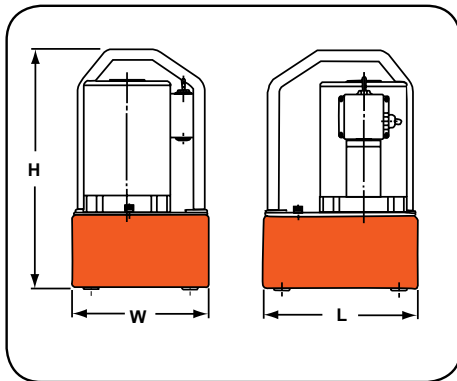

Performance Specifications

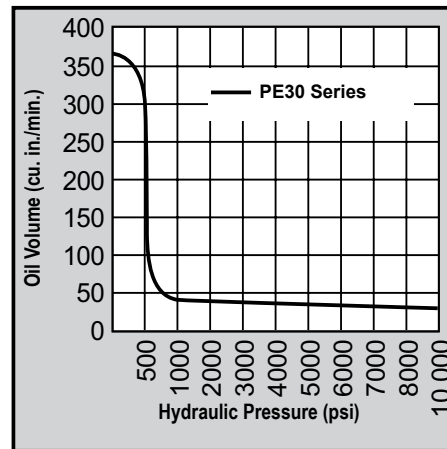

Technical Dimensions

Order No.	Overall Dimensions			Max. Pressure Output (psi)	dBA at Idle and 10,000 (psi)	Amp Draw 115VAC at 10,000 (psi)	Oil Del. (cu. in./min. @)					Prod. Wt. with Oil (lbs.)
	Length	Width	Height				100	500	1,000	5,000	10,000	
	(in.)	(in.)	(in.)				(psi)	(psi)	(psi)	(psi)	(psi)	
PE30 Series with 1.25 gallon reservoir	20.75	18.00	11.50	10,000	87/82	13	300	200	44	38	30	170.00
PE30 Series with 1.75 gallon reservoir	10.00	9.00	16.00	10,000	87/82	13	300	200	44	38	30	41.00

Ordering Information

For Use With Cylinder Type	Description	Order No.	Valve Type	Valve No.	Valve Function	Control Switch	Motor (4,000 rpm)	Reservoir Usable Oil Cap. (cu. in.)
Single-Acting	Base model 1 hp pump with 1.25 gallon reservoir, & 2-position valve.	PE302	3-Way, 2-Position	9584	Advance Hold Return	On/Off Pulse Switch	1 hp 110/115VAC, 50/60 Hz, Single-Phase	280**
Single-Acting	1 hp pump with 1.75 gallon reservoir, & 2-position valve.	PE302-2	3-Way, 2-Position	9584	Advance Hold Return	On/Off Pulse Switch	1 hp 110/115VAC, 50/60 Hz, Single-Phase	380***
Single-Acting	1 hp pump with 1.25 gallon reservoir, 2 position valve, & remote motor control.	PE302R	3-Way, 2-Position	9584	Advance Hold Return	Remote Motor Control (10 ft.)	1 hp 110/115VAC, 50/60 Hz, Single-Phase	280**
Single-Acting	1 hp pump with 1.75 gallon reservoir, 2-position valve, & remote motor control.	PE302R-2	3-Way, 2-Position	9584	Advance Hold Return	Remote Motor Control (10 ft.)	1 hp 110/115VAC, 50/60 Hz, Single-Phase	380***
Single-Acting	1 hp pump with 1.25 gallon reservoir, solenoid-operated remote valve, & remote motor control.	PE302S†	3-Way, 2-Position	9579	Advance Hold Return	Remote Motor Control (10 ft.)	1 hp 110/115VAC, 50/60 Hz, Single-Phase	280**
Single-Acting	1 hp pump with 1.75 gallon reservoir, solenoid-operated remote valve, & remote motor control.	PE302S-2†	3-Way, 2-Position	9579	Advance Hold Return	Remote Motor & Valve (10 ft.)	1 hp 110/115VAC, 50/60 Hz, Single-Phase	380
Single-Acting	1 hp pump with 1.25 gallon reservoir, "Auto Dump" valve.	PE302A∞	Auto Dump	9610	Automatic Pilot Operation	Remote Motor Control (10 ft.)	1 hp 110/115VAC, 50/60 Hz, Single-Phase	280**
Single-Acting	Base model 1 hp pump with 1.25 gallon reservoir & 3-position valve.	PE303	3-Way, 3-Position	9520*	Advance Hold Return	On/Off Pulse Switch	1 hp 110/115VAC, 50/60 Hz, Single-Phase	280**
Single-Acting	1 hp pump with 1.75 gallon reservoir, & 3-position valve.	PE303-2	3-Way, 3-Position	9520*	Advance Hold Return	On/Off Pulse Switch	1 hp 110/115VAC, 50/60 Hz, Single-Phase	380***
Single-Acting	1 hp pump with 1.25 gallon reservoir, 3-position valve, & remote motor control.	PE303R	3-Way, 3-Position	9520*	Advance Hold Return	Remote Motor Control (10 ft.)	1 hp 110/115 VAC, 50/60 Hz, Single-Phase	280**
Single-Acting	1 hp pump with 1.75 gallon reservoir, 3- position valve, & remote motor control.	PE303R-2	3-Way, 3-Position	9520*	Advance Hold Return	Remote Motor Control (10 ft.)	1 hp 110/115VAC, 50/60 Hz, Single-Phase	380***
Double-Acting	Base model 1 hp pump with 1.25 gallon reservoir, & 4-way valve for double-acting systems	PE304	4-Way, 3-Position Tandem Center	9506*	Advance Hold Return	On/Off Pulse Switch	1 hp 110/115VAC, 50/60 Hz, Single-Phase	280**
Double-Acting	1 hp pump with 1.75 gallon reservoir, & 4-way valve for double-acting systems	PE304-2	4-Way, 3-Position Tandem Center	9506*	Advance Hold Return	On/Off Pulse Switch	1 hp 110/115VAC, 50/60 Hz, Single-Phase	380***
Double-Acting	1 hp pump with 1.25 gallon reservoir, 4-way valve for double-acting systems, & remote motor control.	PE304R	4-Way, 3-Position Tandem Center	9506*	Advance Hold Return	Remote Motor Control (10 ft.)	1 hp 110/115VAC, 50/60 Hz, Single-Phase	280**
Double-Acting	1 hp pump with 1.75 gallon reservoir, 4-way valve for double-acting systems, & remote motor control.	PE304R-2	4-Way, 3-Position Tandem Center	9506*	Advance Hold Return	Remote Motor Control (10 ft.)	1 hp 110/115VAC, 50/60 Hz, Single-Phase	380***

* Posi-Check® valve design, Posi-Check® guards against pressure loss when valve is shifted from "advance" to "hold" position.

** Shipped with 1 gal. of oil (231 cu. in., 210 usable).

*** Shipped with 2 gal. of oil.

∞ Not to be used for lifting applications. Best suited for crimping, pressing & punching applications.

† 115VAC, 60 Hz.

NOTE: For 220/230VAC, 50/60 Hz. add suffix "- 220" (example PE302-220).

Model Shown:

PE462A, PE462S, PE464

Pumps



Features

BEST SUITED FOR UNDER-THE-ROOF MAINTENANCE AND PRODUCTION APPLICATIONS.

- Two-speed high-performance pump.
- For use with single or double-acting cylinders at operating pressures up to 10,000 psi.
- Equipped with a 1-1/2 hp, 3,450 rpm single-phase, 60 Hz thermal protected induction motor that starts under full load. Noise level of 77-81 dBA.
- All equipped with a 10 foot remote control except PE462S which has a 25 foot remote control.
- 24VAC control circuit on all units with remote control.
- CSA rated for intermittent duty.

- ▶ PE46 series pump and RD5513 cylinder used in a special press that produces pharmaceutical-grade extracts for herbal medicines.



Performance Specifications

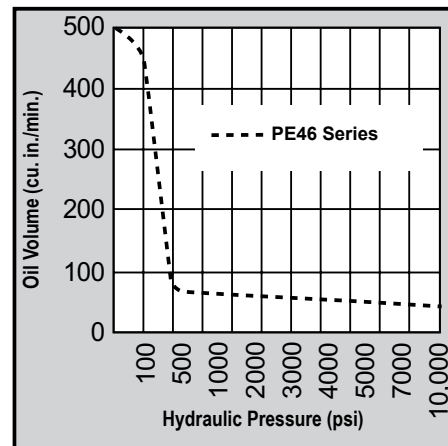

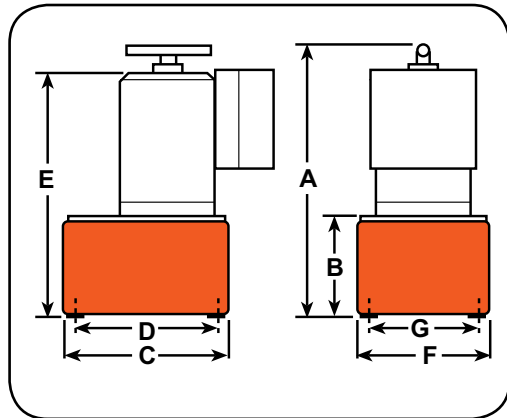

Hydraulic Hoses

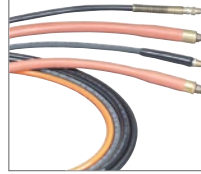

Heavy-duty and thermo plastic hydraulic hoses to meet your requirements and safety factor.

Refer to the accessories section for details.



Hydraulic Fluids



For dependable performance of all your hydraulic pumps and cylinders. Power Team specialty blended oils contains foam suppressant additives and has a high viscosity index. Refer to the Accessories section for complete details

Technical Dimensions

Order No.	A	B	C	D	E	F	G	Max. Pressure Output (psi)	rpm	dBA at Idle and 10,000 (psi)	115VAC Amp Draw at 10,000 (psi)	Oil Del. (cu. in./min. @) †				Prod. Wt. with Oil (lbs.)
	(in.)	(in.)	(in.)	(in.)	(in.)	(in.)	(in.)					100 (psi)	1000 (psi)	5,000 (psi)	10,000 (psi)	
PE46 Series	19.63	6.81	11.50	10.00	18.50	9.50	8.00	10,000	3,450	77/81*	25**	500	450	51	46	79.00

* Measured at 3 ft. distance, all sides.

† Typical delivery. Actual flow will vary with field conditions.

** Requires 20 amp circuit.

Ordering Information

For Use With Cylinder Type	Description	Order No.	Valve Type	Valve No.	Valve Function	Control Switch †††	Motor	Reservoir ***Usable Oil Cap. (cu. in.)
Single-Acting	Base model 1-1/2 hp pump with 2.5 gallon metal reservoir.	PE462	3-Way	9584	Advance Return†	Remote Motor Control (10 ft.) on/off	1 1/2 hp, 115/230VAC* 60 Hz, Single-Phase	590
Single-Acting	1-1/2 hp pump with solenoid valve, & 2.5 gallon metal reservoir.	PE462S††	3-Way	9579	Advance Return**	Remote Motor/ Valve(25 ft.)	1 1/2 hp, 115/230VAC* 60 Hz, Single-Phase	590
Single-Acting	1-1/2 hp pump with "dump valve", & 2.5 gallon metal reservoir.	PE462A [∞]	Auto/Dump 3-Way	9610	Advance Return	Remote Motor Control (10 ft.) on/off	1 1/2 hp, 115/230VAC* 60 Hz, Single-Phase	590
Double-Acting, Multi Single-Acting	1-1/2 hp pump with 9500 double-acting valve, & 2.5 gallon metal reservoir.	PE464	4-Way	9500	Advance Hold Return†	Remote Motor Control (10 ft.) on/off	1 1/2 hp, 115/230VAC* 60 Hz, Single-Phase	590
Double-Acting, Multi Single-Acting	1-1/2 hp pump with 9592 double-acting valve, & 2.5 gallon metal reservoir.	PE464S††	3/4-Way	9592	Advance Return**	Remote Motor/Valve (10 ft.)	1 1/2 hp, 115/230VAC* 60 Hz, Single-Phase	590

* Available with 220VAC 50 Hz motor (to order, place suffix "50-220" behind pump order number). Specify voltage when ordering.

** Advance position holds pressure with motor shut-off.

*** Usable oil is calculated with the oil fill at the recommended level of 1.50" below reservoir cover plate.

† Advance position holds pressure with motor shut-off. Return position returns cylinder.

†† 115VAC, 60 Hz.

††† The remote motor control switch on PE46 series pumps is 24VAC.

[∞] Not to be used for lifting. When pump is shut-off, oil returns to reservoir.

Model Shown:

PE554S, PE552, PE554W

Pumps



Features

INDUSTRY LEADING HEAVY-DUTY PUMP FOR MULTIPLE APPLICATIONS

- 1-1/8 hp, 12,000 rpm, 110/115VAC, 50/60 Hz universal motor. Draws 25 amps at full load, starts at reduced voltage.
- True unloading valve achieves greater pump efficiency, allowing higher flow at maximum pressure.
- Reservoirs available in sizes up to 10 gallons, refer to pump accessories page.
- Lightweight and portable. Best performance-to-weight ratio of all Power Team pumps.
- 10 foot remote motor control (except PE552S which has a 25 foot remote motor and valve control).
- “Assemble to Order” System allows you to choose from a wide range of pre-engineered, off-the-shelf components to build a customized pump to fit specific requirements. Refer to the “Assemble to Order” (ATO) Pump Pages.
- CSA rated for intermittent duty.



Torque Wrench Pumps



For Torque Wrench Pump Configurations, refer to the Tools Section.

Performance Specifications

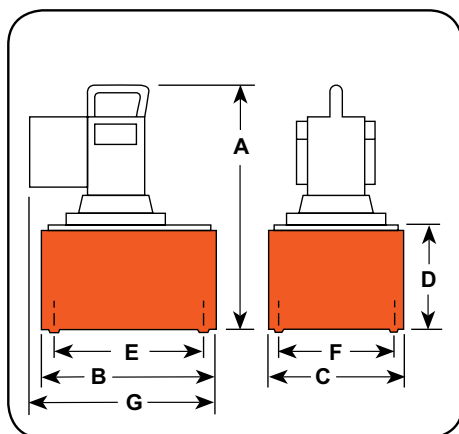
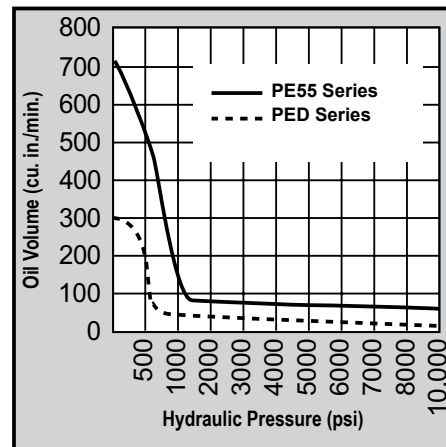

Technical Dimensions

Order No.	A	B	C	D	E	F	G	Max. Pressure Output (psi)	rpm	dBA at Idle and 10,000 (psi)	115VAC* Amp Draw at 10,000 (psi)	Oil Del. (cu. in./min. @)				Prod. Wt. with Oil (lbs.)
												0 (psi)	700 (psi)	5,000 (psi)	10,000 (psi)	
PE55 Series	18.25 (in.)	11.50 (in.)	9.50 (in.)	7.00 (in.)	10.00 (in.)	8.00 (in.)	14.00 (in.)	10,000	12,000	90/89*	25	704 (psi)	440 (psi)	74 (psi)	56 (psi)	65.00

* Amp draw at 10,000 psi, 230VAC 50/60 Hz is 15 Amps.

Ordering Information

For Use With Cylinder Type	Description	Order No. ***	Valve Type	Valve No.	Valve Function	Control Switch ††	Motor	Reservoir Usable Oil Cap. (cu. in.)
Single-Acting	Base model 1-1/8 hp pump with 2.5 gallon reservoir, & remote motor control	PE550	-	-	-	Remote Motor	1 1/8 hp*, 110/115VAC 50/60 Hz, Single-Phase	525
Single-Acting	Base model 1-1/8 hp pump with 5 gallon reservoir, remote motor control, & 3-way valve.	PE550-RP50	-	-	-	Remote Motor	1 1/8 hp*, 110/115VAC 50/60 Hz, Single-Phase	1150
Single-Acting	Base model 1-1/8 hp pump with 2.5 gallon reservoir, remote motor control, & 3-way valve.	PE552	3-Way	9582	Advance Return **	Remote Motor	1 1/8 hp*, 110/115 VAC 50/60 Hz, Single-Phase	525
Single-Acting	1-1/8 hp pump with 2.5 gallon reservoir, remote motor control, & solenoid-operated remote valve.	PE552S	3-Way	9579	Advance Hold Return	Remote Motor & Valve	1 1/8 hp*, 110/115VAC 50/60 Hz, Single-Phase	525
Single-Acting	1-1/8 hp pump with 5 gallon reservoir, remote motor control, & solenoid-operated remote valve.	PE552S-RP50	3-Way	9579	Advance Hold Return	Remote Motor & Valve	1 1/8 hp*, 110/115VAC 50/60 Hz, Single-Phase	1150
Single-Acting	1-1/8 hp pump with 2.5 gallon reservoir, remote motor control, & "Auto Dump" valve.	PE552A∞	Auto/Dump	9610	Advance Return	Remote Motor	1 1/8 hp*, 110/115VAC 50/60 Hz, Single-Phase	525
Single-Acting	1-1/8 hp pump with 2.5 gallon reservoir. Valve has "Posi-Check" feature	PE553	3-Way†	9520	Advance Hold Return	Remote Motor	1 1/8 hp*, 110/115VAC 50/60 Hz, Single-Phase	525
Single-Acting	1-1/8 hp pump with 5 gallon reservoir. Valve has "Posi-Check" feature	PE553-RP50	3-Way†	9520	Advance Hold Return	Remote Motor	1 1/8 hp*, 110/115VAC 50/60 Hz, Single-Phase	1150
Double-Acting	Base model 1-1/8 hp pump with 2.5 gallon reservoir, and 4-way valve for double-acting systems	PE554	4-Way†	9506	Advance Hold Return	Remote Motor	1 1/8 hp*, 110/115VAC 50/60 Hz, Single-Phase	525
Double-Acting	Base model 1-1/8 hp pump with 5 gallon reservoir, and 4-way valve for double-acting systems	PE554-RP50	4-Way†	9506	Advance Hold Return	Remote Motor	1 1/8 hp*, 110/115VAC 50/60 Hz, Single-Phase	1150
Double-Acting	Pump equipped with 3/4-way solenoid valve, and 5 gallon reservoir	PE554S-RP50	3/4-Way	9592	Advance Hold Return	Remote Motor & Valve	1 1/8 hp*, 110/115VAC 50/60 Hz, Single-Phase	1150
Double-Acting	Weather-resistant model 1-1/8 hp pump with 2.5 gallon reservoir, and 4-way valve for double-acting systems.	PE554W	4-Way†	9506	Advance Hold Return	Remote Motor	1 1/8 hp*, 110/115VAC 50/60 Hz, Single-Phase	525
Double-Acting	Weather-resistant model 1-1/8 hp pump with 5 gallon reservoir, and 4-way valve for double-acting systems.	PE554W-RP50	4-Way†	9506	Advance Hold Return	Remote Motor	1 1/8 hp*, 110/115VAC 50/60 Hz, Single-Phase	525
Double-Acting	1-1/8 hp pump with 2.5 gallon reservoir, and 9500 tandem center valve for double-acting systems.	PE554T	4-Way	9500	Advance Hold Return	Remote Motor	1 1/8 hp*, 110/115VAC 50/60 Hz, Single-Phase	525
Double-Acting	For use with single-acting Spring Seat, Stressing Jack or double-acting cylinder.	PE554P	4-Way	9500	Advance Hold Return	Remote Motor	1 1/8 hp*, 110/115VAC 50/60 Hz, Single-Phase	525
Double-Acting	"For use with single-acting or double-acting Power Seat, Stressing Jacks ONLY."	PE554PT	4-Way	9628	Advance Hold Return	Remote Motor	1 1/8 hp*, 110/115VAC 50/60 Hz, Single-Phase	525
Double-Acting	Pump suitable to run multiple spring return tools.	PE554C	4-Way	"9511 †††"	Advance Hold Return	Remote Motor	1 1/8 hp*, 110/115VAC 50/60 Hz, Single-Phase	525
Double-Acting	Pump equipped with 3/4-way solenoid valve.	PE554S	3/4-Way	9592	Advance Hold Return **	Remote Motor & Valve	1 1/8 hp*, 110/115VAC 50/60 Hz, Single-Phase	525

* Pumps available with 230VAC, 60/50 Hz motors. Specify voltage when ordering. See "Assemble to Order" pump options

** Holds with motor shut-off.

† Valves have Posi-Check® feature.

†† All remotes are 10 ft. long except for PE552S which is 25 ft. long.

††† Valving allows alternate and independent operation of two different spring return tools. Valve holds pressure only while valve is in "A" or "B" port position with pump motor shut-off.

∞ Not to be used for lifting.

Model Shown:

PE604T, PE604PT

Pumps



▶ The PE60 used for pre-stressing application



▶ Features

COMPACT, LIGHTWEIGHT PUMP. EXCELLENT CHOICE FOR RUGGED APPLICATIONS AND LOW VOLTAGE STARTING.

- Pump offers long, trouble-free life in the most demanding work environments.
- For operating single or double-acting cylinders, or stressing jacks.
- Powered by 1-1/8 hp, 115VAC, 50/60 Hz single-phase motor. Starts under load, even at reduced voltages at construction sites.
- Optional fan-driven external oil cooler includes rollover guard.
- Insulated carrying handle.
- Integral 4" dia. fluid-filled pressure gauge with steel bezel complies with ASME B40.1 Grade A.
- Sealed 0.754 gallon (usable) reservoir. Reservoir drain port is standard.
- Oil level sight gauge for accurate oil level monitoring.
- External spin-on filter removes contaminants from circulating oil to maximize pump, valve and cylinder/ tool life.
- CSA rated for intermittent duty.

▶ Performance Specifications

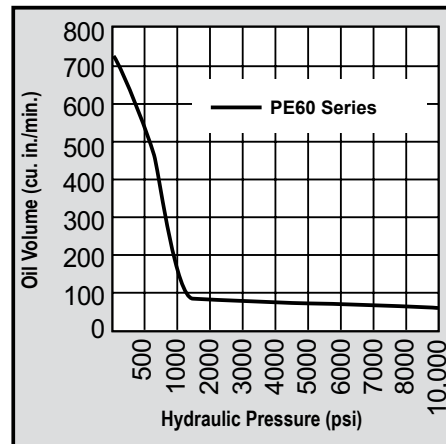



Optional: Oil Cooler Kit

For Use With:	Kit Order No.	Voltage	Wt. (lbs.)
PE604T	252511	115VAC	5.00
or PE604PT	252512	220VAC	5.00



Hydraulic Fluids



For dependable performance of all your hydraulic pumps and cylinders. Power Team specialty blended oils contains foam suppressant additives and has a high viscosity index. Refer to the Accessories section for complete details



Learn More - About Hydraulic Safety Insight



Looking for great safety suggestions? Visit our Resource Section to get a better understanding of hydraulic and mechanical safety insights on what to look for when working around hydraulics

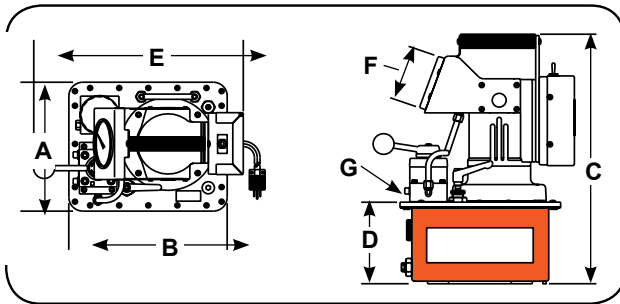

Technical Dimensions

Order No.	A	B	C	D	E	F	G	Max. Pressure Output (psi)	rpm	dBA at Idle and 10,000 (psi)	115VAC Amp Draw at 10,000 (psi)	Oil Del. (cu. in./min. @)				Prod. Wt. with Oil (lbs.)
	(in.)	(in.)	(in.)	(in.)	(in.)	(in.)	(in.)					0 (psi)	700 (psi)	5,000 (psi)	10,000 (psi)	
PE604T	9.31	11.50	18.25	6.00	15.00	4.00	3/8 NPTF	10,000	10,000	80/85	25	704	440	74	56	50.00
PE604PT	9.31	11.50	18.25	6.00	15.00	4.00	3/8 NPTF	10,000	12,000	80/85	25	704	440	74	56	51.00

NOTE: Unloading pressure is 1,000 psi.

Ordering Information

For Use With Cylinder Type	Description	Order No.	Valve Type	Valve No.	Valve Function	Control Switch	Motor	Reservoir Usable Oil Cap. (cu. in.)
Single-Acting, Spring Seat, Stressing Jack or Double-Acting	1-1/8 hp pump with 0.75 gallon reservoir & valve for double-acting systems.	PE604T	4-Way/3-Position	9500	Advance Hold Return	On/Off Pulse	1-1/8 hp, 115VAC 60/50 Hz, Single-Phase	157
Single-Acting or Double-Acting Power Seat, Stressing Jacks Only	1-1/8 hp pump with 0.75 gallon reservoir & a special valve for post-tensioning application only.	PE604PT	4-Way/3-Position	9628 Model C	Advance Hold Sequenced Return	On/Off Pulse	1-1/8 hp, 115VAC 60/50 Hz, Single-Phase	157

NOTE: Contact Factory for PE60 pump models with other control and valve options.

NOTE: For 220/230VAC, 50/60 Hz, single-phase models, add -220 suffix.

Model Shown:

PQ603, PQ604, PQ604S

Pumps



▶ **Hydraulic Machine Press Operation.**



▶ **Features**

PUMP DESIGNED SPECIFICALLY FOR HEAVY-DUTY, EXTENDED CYCLE OPERATION.

- For operating single or double-acting cylinders.
- Metal shroud keeps dirt and moisture out of motor and electrical components.
- Electrical shut-down feature prevents unintentional restarting of motor following an electrical service interruption.
- Internal relief valve limits pressure to 10,000 psi.
- External relief valve is adjustable from 1,000 to 10,000 psi.
- Pumps operate below maximum OSHA noise limitation (74-76 dBA).
- Start and operate under full load, even with voltage reduced by 10%.
- CSA rated for intermittent duty.



Hydraulic Fluids



For dependable performance of all your hydraulic pumps and cylinders. Power Team specialty blended oils contains foam suppressant additives and has a high viscosity index. Refer to the Accessories section for complete details

▶ **Performance Specifications**

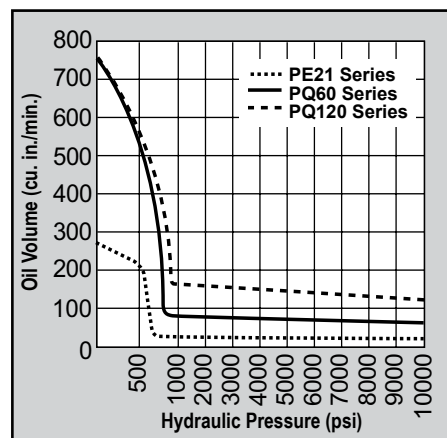



Universal Pump Cart



Mobilize your hydraulic pumps with the cart # PC200 - refer to the accessories section for details. Cart can be used with the following pumps; PA60, PA64, PA55/PE55, PE18, PE21, PQ60, PQ120, PG55 series and pumps with optional 5- and 10-gallon reservoirs; Nos. RP50, RP51, RP101 and RP103. (Pump not included)



Optional: Swivel Casters



Order No.	Description	Wt. (lbs.)
10494	2" dia. swivel casters (4 Required)	0.30

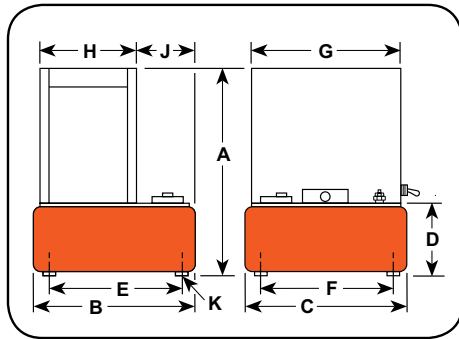

Technical Dimensions

Order No.	A	B	C	D	E	F	G	H	J	K	Max. Pressure Output (psi)	rpm	dBA at Idle and 10,000 (psi)	Oil Del. (cu. in./min. @)				Prod. Wt. with Oil (lbs.)
	(in.)	(in.)	(in.)	(in.)	(in.)	(in.)	(in.)	(in.)	(in.)	(in.)				100 (psi)	1000 (psi)	5,000 (psi)	10,000 (psi)	
PQ60 Series	25.13	14.25	15.50	7.25	12.13	13.31	14.69	9.31	4.81	1/2-20 UNF	10,000	1,725	74/76 *	730	70	65	60	169.00**

* Measured at 3 ft. distance, all sides.

** Total weight with oil and 3-way solenoid valve. Subtract 10 lbs. to obtain weight of pump with manual valve.

Ordering Information

For Use With Cylinder Type	Description	Order No.	Valve Type	Valve No.	Valve Function	Max. Amp Draw @ 10,000 (psi)	Motor ††	Reservoir Usable Oil Cap. (cu. in.)
Single-Acting	2 hp pump with 5.7 gallon reservoir and manual valve.	PQ603	3-Way	9520*	Advance Hold Return	115VAC -22 amps 230VAC -11 amps	2 hp, 230VAC 60 Hz, Single-Phase	1,250
Single-Acting	2 hp pump with 5.7 gallon reservoir and solenoid-operated remote valve.	PQ603S	3-Way	9599†	Advance Hold Return	115VAC -22 amps 230VAC -11 amps	2 hp, 230VAC 60 Hz, Single-Phase	1,250
Double-Acting	2 hp pump with 5.7 gallon reservoir and manual valve.	PQ604	4-Way	9506*	Advance Hold Return	115VAC -22 amps 230VAC -11 amps	2 hp, 230VAC 60 Hz, Single-Phase	1,250
Double-Acting	2 hp pump with 5.7 gallon reservoir and solenoid-operated remote valve.	PQ604S	4-Way	9512†	Advance Hold Return	115VAC -22 amps 230VAC -11 amps	2 hp, 230VAC 60 Hz, Single-Phase	1,250

* Manual valve. Pump is equipped with RUN/OFF/PULSE switch for control of motor.

† Solenoid valve. Pump is equipped with a remote control switch with 10 ft. cord.

†† PQ60 series also available in 115VAC, 60 Hz or 220VAC, 50 Hz. Please specify when ordering. Example: for 60 Hz order PQ603-115; for 50 Hz order PQ603-50-220.

NOTE: Some Power Team pumps are available in special configurations not listed in this catalog. For your special requirements please consult your local distributor or the Power Team factory.

Model Shown:

PQ1203, PQ1204, PQ1204S

Pumps



▶ **PQ series pump used to drive piers to lift and stabilize building foundation.**



▶ Features

PUMP DESIGNED SPECIFICALLY FOR HEAVY-DUTY, EXTENDED CYCLE OPERATION.

- Start and operate under full load, even with voltage reduced by 10%.
- Electrical shut-down feature prevents unintentional restarting of motor following an electrical service interruption.
- Internal relief valve limits pressure to 10,000 psi.
- External relief valve is adjustable from 1,000 to 10,000 psi.
- Pump pre-wired at factory with a 3 hp, 460VAC, 60 Hz, three-phase motor. Other electrical configurations are available. See ordering information on the following page.
- 24VAC control circuit on units with remote control for added user/operator safety.
- Thermal overload protection, motor starter and heater element supplied as **standard equipment**.
- Metal shroud keeps dirt and moisture out of motor and electrical components.
- Pumps operate below OSHA noise limitation (74-76 dBA).
- CSA rated for intermittent duty.

▶ **Performance Specifications**

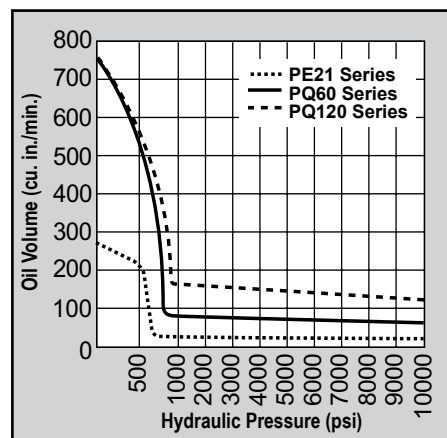

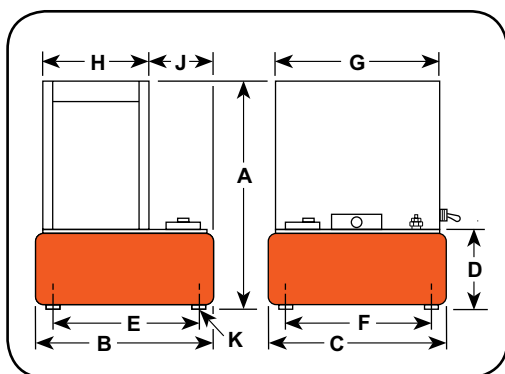

Optional: Swivel Casters (4)



Order No.	Description	Wt. (lbs.)
10494	2" dia. swivel casters	0.30



Analog Gauges



Improve your system visibility and safety by adding an in-line hydraulic gauge to your circuit.

9440 (2.5 in.), 9052 (4 in.), and 9089 (6 in.)

Technical Dimensions

Order No.	A	B	C	D	E	F	G	H	J	K	Max. Pressure Output (psi)	rpm	dBA at Idle and 10,000 (psi)	Oil Del. (cu. in./min. @)				Prod. Wt. ** with Oil (lbs.)
	(in.)	(in.)	(in.)	(in.)	(in.)	(in.)	(in.)	(in.)	(in.)	(in.)				0 (psi)	1000 (psi)	5,000 (psi)	10,000 (psi)	
PQ120 Series	25.13	14.25	15.50	7.25	12.13	13.31	14.69	9.31	4.81	1/2-20 UNF	10,000	1,725	73/78	730	160	130	120	164.00

** Total weight with oil and 3-way solenoid valve. Subtract 10 lbs. to obtain weight of pump with manual valve.

Ordering Information

For Use With Cylinder Type	Description	Order No.	Valve Type	Valve No.	Valve Function	Max. Amp Draw @ 10,000 (psi)	Motor ††	Reservoir Usable Oil Cap. (cu. in.)
Single-Acting	3 hp pump with 5.7 gallon reservoir and manual valve.	PQ1203	3-Way	9520*	Advance Hold Return	230VAC -10.5 amps 460VAC -5.3 amps	3 hp, 460VAC 60 Hz, Three-Phase	1,250
Single-Acting	3 hp pump with 5.7 gallon reservoir and solenoid-operated remote valve.	PQ1203S	3-Way	9599†	Advance Hold Return	230VAC -10.5 amps 460VAC -5.3 amps	3 hp, 460VAC 60 Hz, Three-Phase	1,250
Double-Acting	3 hp pump with 5.7 gallon reservoir and manual valve.	PQ1204	4-Way	9506*	Advance Hold Return	230VAC -10.5 amps 460VAC -5.3 amps	3 hp, 460VAC 60 Hz, Three-Phase	1,250
Double-Acting	3 hp pump with 5.7 gallon reservoir and solenoid-operated remote valve.	PQ1204S	4-Way	9512†	Advance Hold Return	230VAC -10.5 amps 460VAC -5.3 amps	3 hp, 460VAC 60 Hz, Three-Phase	1,250

* Manual valve. Pump is equipped with RUN/OFF/PULSE switch for control of motor.

† Solenoid valve. Pump is equipped with a remote control switch with 10 ft. cord.

†† PQ120 series also available in 230VAC 60 Hz or 220/380VAC 50 Hz. Please specify when ordering. Example: for 60 Hz order PQ1204S-230; for 50 Hz. order PQ1204S-50-220 or PQ1204S-50-380.

NOTE: PQ120 Series also available in 575VAC 60 Hz. Consult the factory.

Model Shown:
PE4004S

Pumps



▶ **PE4004S pump and RD3006 cylinder used in a special press which repairs damaged chain links for the shipping industry.**

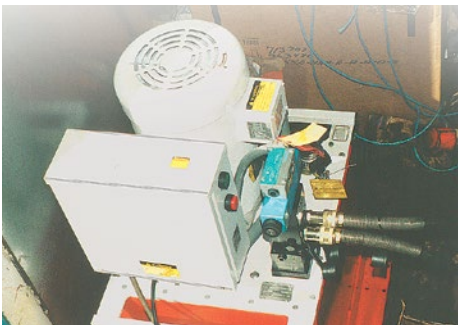

▶ Features

PUMP DESIGNED SPECIFICALLY FOR HEAVY-DUTY, EXTENDED CYCLE OPERATION.

- Two-speed high output pump delivers up to 5 gpm of oil.
- Low noise level of 73-80 dBA.
- Integral electrical shut-down feature prevents unintentional restarting of motor following an electrical service interruption. Over-current protection prevents damage to motor as a result of overheating.
- “Stop” and “Start” control buttons are 24VDC.
- PE4004 has a 4-way/3-position manual valve.
- PE4004S has a 4-way/3-position solenoid valve with a 24VDC remote hand switch.
- External pressure relief valve is adjustable from 1,500 to 10,000 psi.
- Heavy-duty 4” diameter casters assure easy maneuvering.
- 20 gallon (3,927 cu. in. usable) reservoir has a low oil level sight gauge.
- Powered by a dual voltage 10 hp, three-phase, 1,725 rpm motor.
- Three-phase motor has all the electrical components necessary to operate the pump. **The customer has no hidden charges when making a purchase.**
- Deliver 1,200 cu. in./min. of oil @ 200 psi, 420 cu. in./min. of oil @ 10,000 psi.
- CSA rated for intermittent duty.

▶ Performance Specifications

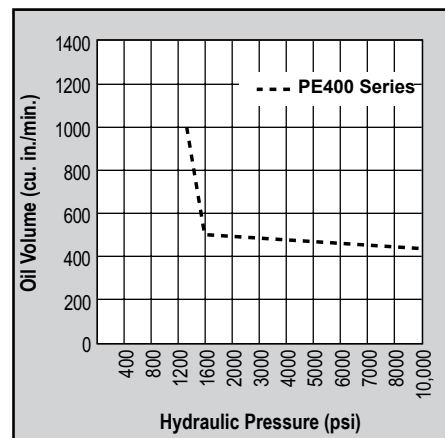

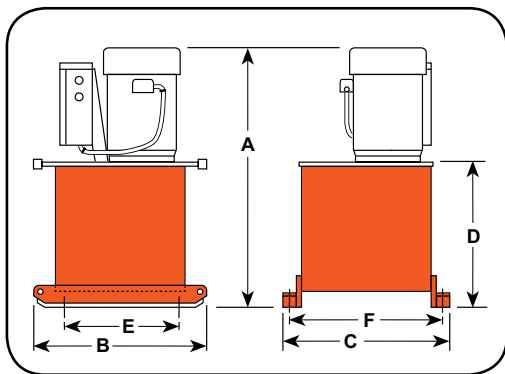

Analog Gauges



Improve your system visibility and safety by adding an in-line hydraulic gauge to your circuit.

9440 (2.5 in.), 9052 (4 in.), and 9089 (6 in.)



Load Lowering Valve



Precision metering for controlled cylinder piston return. Operation: Permits free flow when extending cylinder, built-in pressure relief and Posi-Check® locks and holds load in raised position until operator opens valve.

Ordering number: 9596



Learn More - About Hydraulic Safety Insight



Looking for great safety suggestions? Visit our Resource Section to get a better understanding of hydraulic and mechanical safety insights on what to look for when working around hydraulics

Technical Dimensions

Order No.	A	B	C	D	E	F	Max. Pressure Output (psi)	rpm	dBA at Idle and 10,000 (psi)	Max. Amp Draw @ 10,000 (psi)	Oil Del. (cu. in./min. @)				Prod. Wt. * with Oil (lbs.)
	(in.)	(in.)	(in.)	(in.)	(in.)	(in.)					200 (psi)	1,200 (psi)	5,000 (psi)	10,000 (psi)	
PE4004	36.38	25.00	24.00	21.25	15.50	21.50	10,000	1,725	73/80	34 @230VAC	1,200	1,050	450	420	492.00
PE4004S	36.38	25.00	24.00	21.25	15.50	21.50	10,000	1,725	73/80	17 @460VAC	1,200	1,050	450	420	506.00

* Add 5" and 8 lbs. when casters are mounted. (Units are supplied with four 4" dia. swivel casters.)

Ordering Information

For Use With Cylinder Type	Description	Order No.	Valve Type	Valve No.	Valve Function	Max. Amp Draw @ 10,000 (psi)	Motor	Reservoir Usable Oil Cap. † (cu. in.)
Double-Acting	10 hp pump with 20 gallon reservoir and manual valve.	PE4004	4-Way	9506	Advance Hold Return	230VAC -10.5 amps 460VAC -5.3 amps	10 hp, 208/230/460VAC* 60 Hz, 3-Phase	3,927†
Double-Acting	10 hp pump with 20 gallon reservoir and solenoid-operated remote valve.	PE4004S	4-Way	9512**	Advance Hold Return	230VAC -10.5 amps 460VAC -5.3 amps	10 hp, 208/230/460VAC* 60 Hz, 3-Phase	3,927†

* Factory wired for this voltage. For 230VAC, 60Hz order PE4004S-230.

** Solenoid valve with remote control.

† Usable oil is calculated with oil fill at recommended level at 2.25" below cover plate.

NOTE: Valves for spring return cylinders are available upon request. Consult the factory.

Model Shown:
MCS-PE554-8

Pumps



>Features

SYNCHRONIZED POWER UNIT FOR POSITIONING, LIFTING OR LOWERING LOADS, ACCURATE TO +/- 0.040 IN.

- Basic systems includes eight (8) jacking points, contact Power Team for larger MCS system requirements.
- Safety features included: full stop due to power failure, sensor failure, pressure overload, tolerance error, uncontrolled load movement, etc.
- Intuitive graphic touch screen control.
- Displayed information includes: startup diagnostics, position of lift points relative to starting position, pressure at each lift point, status of each cylinder and status of alarms.
- MCS works with a wide range of cylinders types, tonnages and strokes to meet your application requirements.
- Operating pressure up to 10,000 psi.
- Standard system has a 40 gallon tank.



Touch Screen Enclosure



- Weather tight enclosure protects your investment while in storage.
- Hinged cover provides protection for HMI touch screen.
- Designed to act as a sun screen in bright conditions.



Cylinder Selection



Power Team recommends using 80% of the rated capacity and stroke to maximize product performance and safety.

▶ **Power Team supplied the lift equipment expertise for this drag line maintenance operation to successfully complete the job on time.**

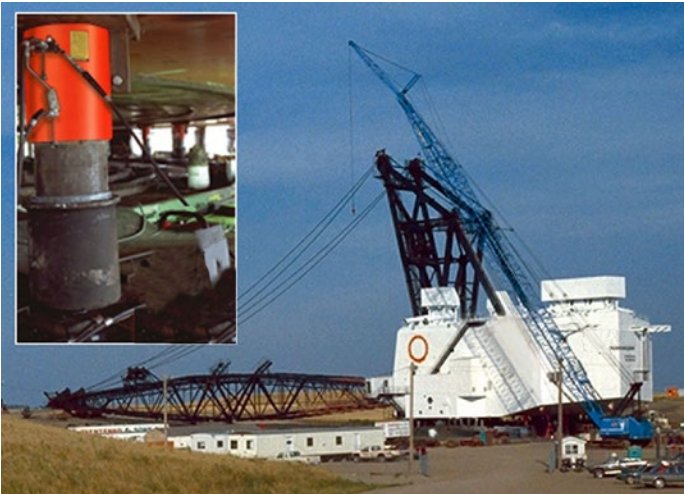

Technical Dimensions

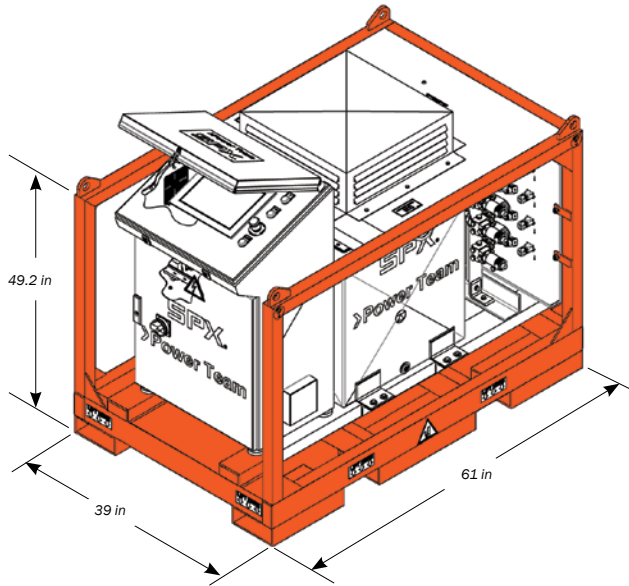

Training Provided



Every MCS includes one day of on-site training at one of SPX FLOW's Regional Headquarters (Rockford, IL USA, Singapore or Netherlands). Training includes both classroom and hands-on instruction. Travel & lodging not included.



Optional Cylinders

Power Team offers a wide variety of single-acting, double-acting, lock nut, pancake and center hole cylinders to meet your requirements.



Pumps

Hardware Included



Crate

Motion Control System (MCS) is protected with a robust cage and reusable shipping container.



Sensors

Linear Displacement Sensors have a range of 19.7 in. Two cases with four sensors included. Refer to the ordering table for the 39.4 in. ordering option.



Cables

Cables for sensors are 100 ft. in length, eight sets and a hard plastic case.



Plug

Electrical plug female connector allows for quick attachment to your line cord.

Ordering Information

Order No.	Max. Lift Points	Pump Flow @ 10,000 (psi.) (cu. in. / min.)	Reservoir Size (gal.)	Motor Voltage	Max. Pressure (psi.)	Valves Included	Transducers Included	Weight w/oil (lbs.)
MCS-PE554-8	8	55	40	1.125 hp (230VAC, 1Ø)	10,000	4-Way / 3-Pos. & 2-Way / 2-Pos.	Pressure & Linear Position (500 mm)	1700
MCS-PQ1204-8	8	120		3 hp (230VAC, 3Ø, 60 Hz)				1715
MCS-PQ1204-460-8	8	120		3 hp (460VAC, 3Ø, 60 Hz)				1715
MCS-PQ1204-50-220-8	8	120		3 hp (220VAC, 3Ø, 50 Hz)				1715
MCS-PQ1204-50-380-8	8	120		3 hp (380VAC, 3Ø, 50 Hz)				1715

Note: To upgrade to a 39.4 in linear position sensor, add "-1M" to the end of the part number. Example MCS-PE554-8-1M.

Model Shown:
PE-NUT

Pumps



Features

EXTREMELY DURABLE YET LIGHTWEIGHT AND OPERATE UNDER LOW-LINE VOLTAGE CONDITIONS.

- 5/8 hp universal electric motor (50/60 Hz cycle), intermittent duty pump.
- Two-stage pump for rapid ram advance.
- Operational under low-line voltage conditions.
- Designed for use with spring-returned remote tools.
- High-pressure safety relief valve.
- Remote hand control with 10-foot cord.
- Carrying handle.
- Factory filled oil reservoir.
- Pressure matched quick-coupler supplied.
- Piston-type high-pressure pump supercharged by a low-pressure pump.
- Optional operating pressures available (consult Power Team factory for details).
- Optional carrying case.

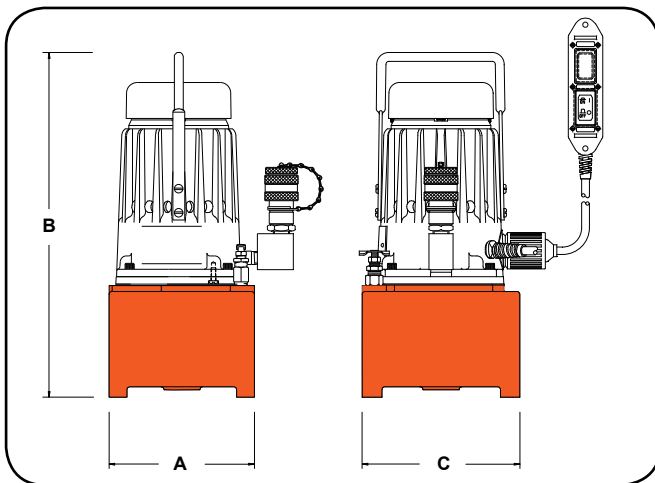

CAUTION

DESIGNED FOR CRIMPING APPLICATIONS ONLY!

This system should not be used for lifting.



Electrical Data

Electric Motor	Electric Control
5/8 hp, 10,000 rpm 115VAC, 50/60 Hz 11 amp current draw (115VAC @ 10,000 PSI)	Remote control with 10-foot cord

Ordering Information

Order No.	Overall Dimensions			Oil Delivery		Reservoir		Prod. Wt. With Oil (lbs.)
	A	B	C	100 (psi)	10,000 (psi)	Oil Cap.	Usable Oil Cap.	
	Width (in.)	Length (in.)	Depth (in.)	(cu. in./min.)	(cu. in./min.)	(cu. in.)	(cu. in.)	
PE-NUT	6.50	14.38	8.25	160	60	93	43	28.00
PE-NUTC*	6.50	14.38	8.25	160	60	93	43	28.00

* Includes Case

Model Shown:
PG1203/4S-CP



>Features

**TWO-STAGE PUMP FOR CRIMPING APPLICATIONS
PG1203-CP**

- 6 hp Briggs & Stratton engine.
- Manual control valve.
- High-pressure safety relief valve.
- Protective roll cage.
- For use with single acting tools.

PG1203/4S-CP

- 5.5 hp Honda OHV-type engine.
- Solenoid valve with remote hand control with 10' cord.
- Two-stage pump for rapid advance.
- High-pressure safety relief valve.
- Protective roll cage.
- For use with either single or double-acting tools.

Pumps



Hydraulic Hoses

Heavy-duty and thermo plastic hydraulic hoses to meet your requirements and safety factor.

Refer to the accessories section for details.

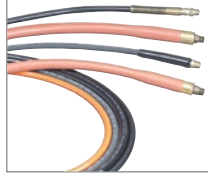

CAUTION

DESIGNED FOR CRIMPING APPLICATIONS ONLY!

This system should not be used for lifting.

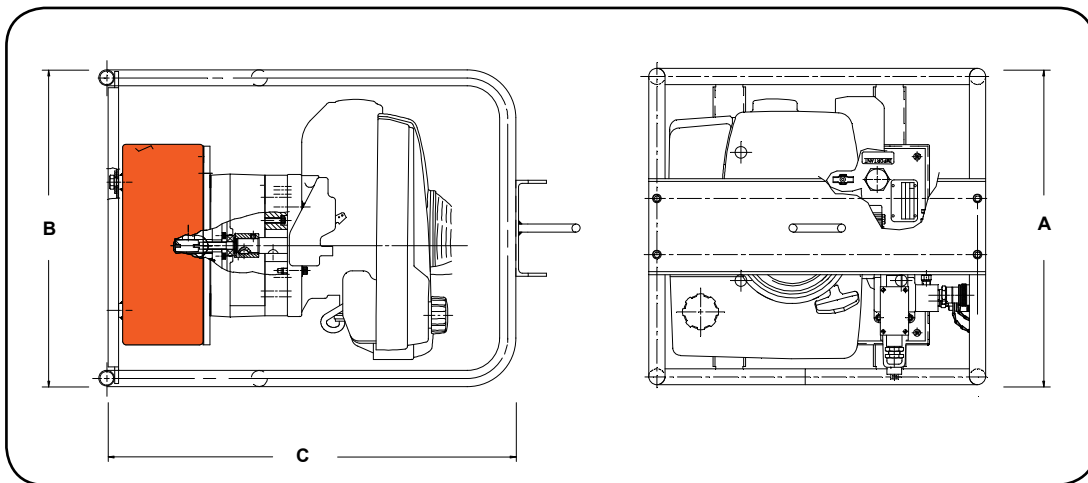

Ordering Information

Order No.	Overall Dimensions			Oil Delivery		Reservoir		Prod. Wt. With Oil (lbs.)
	A	B	C	100 (psi)	10,000 (psi)	Oil Cap. (gal.)	Usable Oil Cap. (cu. in.)	
	Width (in.)	Length (in.)	Depth (in.)	(cu. in./min.)	(cu. in./min.)			
PG1203-CP	19.75	21.75	24.50	480	130	3	700	154.00
PG1203/4S-CP	19.75	21.75	24.50	480	130	3	700	154.00

Model Shown:
PG304, PG554

Pumps



Features

GASOLINE POWER IDEAL FOR REMOTE LOCATIONS.

- A logical choice at work sites where electricity or compressed air are unavailable. For single or double-acting cylinders at operating pressures up to 10,000 psi.
- All gasoline engine/hydraulic pumps feature Posi-Check® valve to guard against pressure loss when valve is shifted from “advance” to “hold.”

PG303 and PG304 (Up to 75 Ton)

- Powered by a 4-cycle, 2 hp Honda engine giving it the lowest weight to horsepower ratio of all gasoline driven pumps.
- Has an aluminum reservoir with 375 cu. in. of usable oil.
- PG30 series pumps are equipped with roll cages to protect pump from damage.
- PG303 is for single-acting cylinders, has a 9520 valve with separate internal return line which allows oil from running pump to return to reservoir, independently of cylinder return oil, when valve is in “return” position.
- PG304 is for double-acting cylinders, has a 9506 4-way (tandem center) valve.

PG553 and PG554 (Up to 150 Ton)

- 6 hp Intek “Diamond Edge” 4-cycle, by Briggs & Stratton.
- 5 gallon reservoir.
- PG553 has a 9520 3-way valve for single-acting cylinders.
- PG554 has a 9506 4-way valve for double-acting cylinders.
- Optional roll cage available.

▶ Gasoline Powered Hydraulic Pumps like this PG303 help provide hydraulic force at remote locations.



▶ Performance Specifications

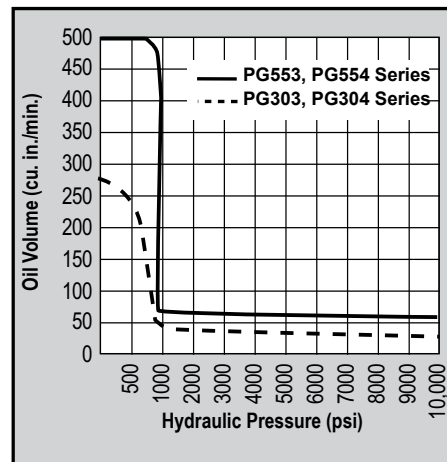



Hydraulic Hoses

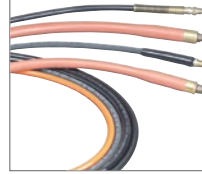

Heavy-duty and thermo plastic hydraulic hoses to meet your requirements and safety factor.

Refer to the accessories section for details.

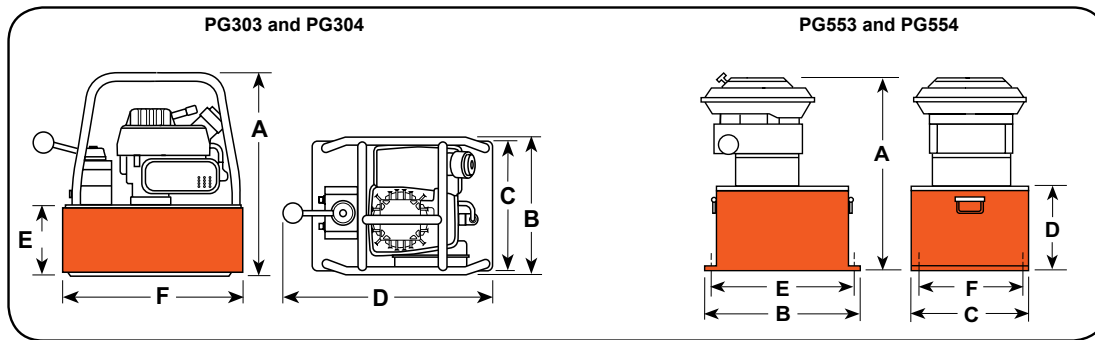

Technical Dimensions

Order No.	A	B	C	D	E	F	Max. Pressure Output	rpm	Oil Del. (cu. in./min. @)				Prod. Wt. with Oil (lbs.)
									100 (psi)	1000 (psi)	5,000 (psi)	10,000 (psi)	
PG303, PG304	14.88 (in.)	10.38 (in.)	9.50 (in.)	16.00 (in.)	5.13 (in.)	13.50 (in.)	10,000 (psi)	6,000	275*	40	35	30	32.00
PG553, PG554	22.00 (in.)	18.00 (in.)	12.50 (in.)	8.63 (in.)	16.63 (in.)	20.25 (in.)	10,000 (psi)	3,600	480	75	70	55	120.00

* First stage oil delivery from 0-400 psi @ 230 cu. in. per minute minimum.

Ordering Information

For Use With Cylinder Type	Description	Order No.	Valve Type	Valve No.	Valve Function	Reservoir Usable Oil Cap. (cu. in.)	Horsepower	Cycle
Single-Acting	2 hp pump with 2 gallon reservoir and single-acting valve.	PG303	3-Way	9520	Advance Hold Return	375	2	2
Single-Acting	6 hp pump with 5.7 gallon reservoir and single-acting valve.	PG553	3-Way	9520	Advance Hold Return	1,300*	6	4
Double-Acting	2 hp pump with 2 gallon reservoir and double-acting valve.	PG304	4-Way	9506	Advance Hold Return	375	2	2
Double-Acting	6 hp pump with 5.7 gallon reservoir and double-acting valve.	PG554	4-Way	9506	Advance Hold Return	1,300*	6	4

* Usable oil is calculated with oil fill at recommended level at 1/2" below cover plate.

Model Shown:

PG4204S, PG1204S, PG1200M-4D

Pumps



Features

TWO-SPEED HIGH-PERFORMANCE PUMPS IDEAL FOR CONSTRUCTION, STRUCTURE MOVING AND RIGGING APPLICATIONS.

- A logical choice at work sites where electricity or compressed air are unavailable. For single or double-acting cylinders at operating pressures to 10,000 psi.
- All gasoline engine/hydraulic pumps feature Posi-Check® valve to guard against pressure loss when valve is shifted from “advance” to “hold.”
- PG1200 Series pumps powered by a Honda 4-cycle, 5.5 hp engine with automatic decompression and electronic ignition. Deliver over 0.5 gallon (130 cu. in.) of oil per minute at 10,000 psi.
- A 5 gallon reservoir means adequate capacity for multi-cylinder applications. Dual element air cleaner protects engine from dusty environments.
- Heavy-duty “roll cage” provides pick-up points for lifting. Horizontal bars on PG1203, PG1204 and PG1204S protect unit, provide hand holds for carrying.
- Rubber anti-skid insulation on bottom of reservoir resists skidding and dampens vibration. PG1200M-4 and PG1200M-4D include a pump cart with 12” wheels.
- Adjustable external pressure regulator.
- CSA rated for intermittent duty.

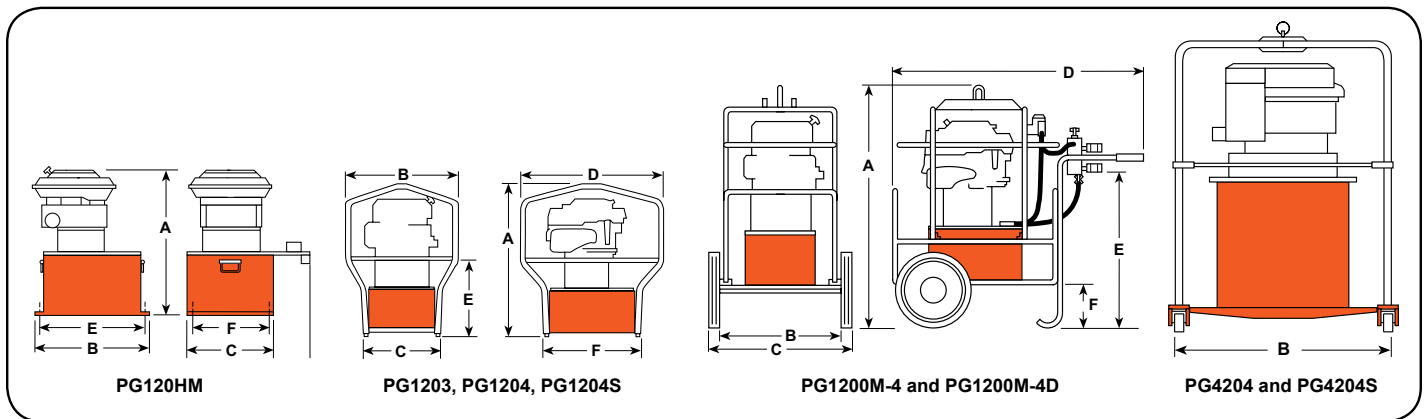

Technical Dimensions

Order No.	A (in.)	B (in.)	C (in.)	D (in.)	E (in.)	F (in.)	Max. Pressure Output (psi)	rpm	Oil Del. (cu. in./min. @)				Prod. Wt. with Oil (lbs.)
									100 (psi)	1,000 (psi)	5,000 (psi)	10,000 (psi)	
PG120HM	23.00	15.50	14.25	19.00	13.31	12.13	10,000	3,600	480	175	150	130	150.00
PG1203	27.88	20.25	14.25	26.25	13.50	18.25	10,000	3,600	480	175	150	130	154.00
PG1204	27.88	20.25	14.25	26.25	13.50	18.25	10,000	3,600	480	175	150	130	154.00
PG1204S	27.88	20.25	14.25	26.25	13.50	18.25	10,000	3,600	480	175	150	130	161.00
PG1200M-4	42.13	18.00	25.00	42.50	26.25	7.25	10,000	3,600	480	175	150	130	260.00
PG1200M-4D	42.13	18.00	25.00	42.50	26.25	7.25	10,000	3,600	480	175	150	130	280.00
PG4204	50.25	52.00	52.00	—	—	—	10,000	3,600	1,240	1,120	475	400	435.00
PG4204S	50.25	52.00	52.00	—	—	—	10,000	3,600	1,240	1,120	475	400	440.00

PG1200M-4

- For single-acting cylinders. Has 9520 3-way/3-position (tandem center) valve, 9596 load-lowering valve and 9644 4-port manifold with individual needle valves at each port.
- Has a 9796 coupler and 9797 dust cap at each port. Valving permits precise individual control of up to four cylinders.
- A 9052 heavy-duty, fluid filled pressure gauge (0-10,000 psi) is included.

PG1200M-4D

- For single or double-acting cylinders with precise individual control of up to four cylinders possible.
- Equipped same as PG1200M-4, except has 9506 4-way/3-position (tandem center) valve, and second 4-port manifold without needle valves mounted beneath 9644 manifold for operating double-acting cylinders.

PG420 Series Maximum Output Hydraulic Power Package

- Ideal for single or multiple cylinder applications. Has a 4-cycle, 20 hp Honda engine and 20 gallon hydraulic reservoir (17 gallons usable) with low oil level sight gauge.
- Steel roll cage protects pump, has a lifting hook, and 4" dia. swivel casters provide mobility.
- Delivers 400 cu. in. of oil at maximum operating pressure.
- Has a 9506 4-way valve. On/off switch and speed control are protected by a panel. Sturdy molded case protects battery (not included).
- USA EPA Clean Air Act EVAP Certified Product.

▶ Performance Specifications

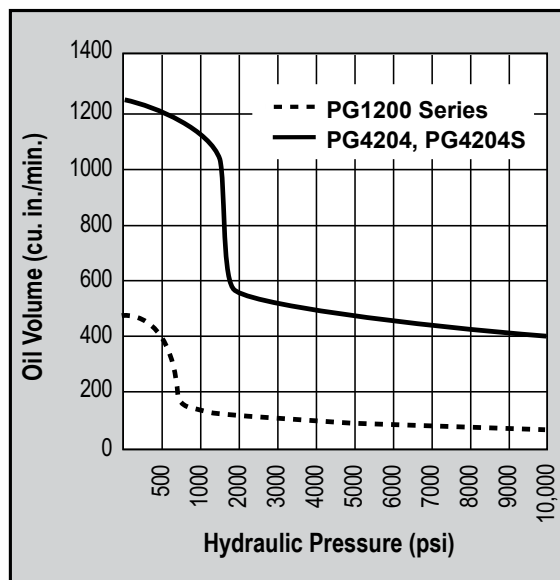

▶ Ordering Information

For Use With Cylinder Type	Description	Order No.	Valve Type	Valve No.	Valve Function	Reservoir *Usable Oil Cap. (cu. in.)	Horsepower	Cycle
Single-Acting	Base model 5 1/2 hp gasoline pump with 5.7 gallon reservoir.	PG1203	3-Way	9520	Advance Hold Return	1,300	5.5	4
Double-Acting	Base model 5 1/2 hp gasoline pump, with 5.7 gallon reservoir, roll cage, and double-acting valve.	PG1204	4-Way	9506	Advance Hold Return	1,300	5.5	4
Double-Acting	5 1/2 hp gasoline pump, with 5.7 gallon reservoir, roll cage, solenoid valve, and 25 feet cord.	PG1204S	4-Way Solenoid***	9516	Advance Hold Return	1,300	5.5	4
Double-Acting	5 1/2 hp gasoline pump with 5.7 gallon reservoir, roll cage, load-lowering valve, 4 port manifold, gauge, and double-acting systems.	PG1200M-4D	4-Way Manifold	9506 9642	Advance Hold Return**	1,300	5.5	4
Double-Acting	Base model 20 hp pump with 20 gallon reservoir.	PG4204	4-Way	9506	Advance Hold Return	3,927	20	4
Double-Acting	20 hp pump with 20 gallon reservoir, and solenoid-operated remote valve.	PG4204S	4-Way Solenoid***	9516	Advance Hold Return	3,927	20	4

* Usable oil is calculated with oil fill at recommended level at 2.25" below cover plate.

** Control up to 4 cylinders independently.

*** Has 25 ft. remote control cord.

Model Shown:

PG4204S, PG1204S, PG1200M-4D

Pumps



Features

CONVERTS LOW-PRESSURE PORTABLE HYDRAULIC PUMPS OR ON-BOARD HYDRAULIC SYSTEMS, INTO HIGH PRESSURE POWER SOURCES.

- Applications include utilities, railroads, construction, riggers and others.
- Operates single or double-acting cylinders, jacks, and tools such as crimper's, spreaders, cable cutters, or tire tools. Version for use with double-acting torque wrenches available.
- May be used to operate two separate, single-acting tools (with integral valves) independently, without need for additional manifold.
- Compact and rugged for use inside a utility vehicle aerial bucket or stowing in a vehicle.
- No reservoir level to maintain; uses low pressure system as oil supply.
- Has 3/8" NPTF ports; compatible with standard fittings for low and high pressure systems.

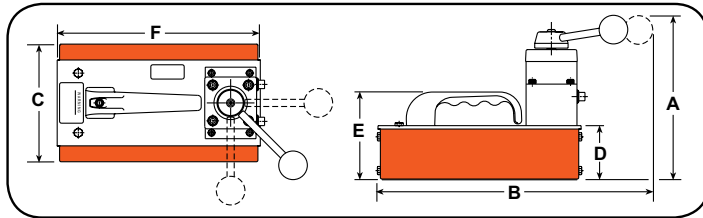

Technical Dimensions

Order No.	A	B	C	D	E	F	Max. Pressure Output	Prod. Wt. with Oil
	(in.)	(in.)	(in.)	(in.)	(in.)	(in.)	(psi)	(lbs.)
HB44	8.63	14.50	6.13	2.75	4.50	10.50	44	16.00

Ordering Information

For Use With Cylinder Type	Description	Order No.	Valve Type	Valve No.	Output Flow Valve Function	Input Flow Range (gpm)	Input Flow Pressure (psi)	Output Flow Range (gpm)
Single-Acting	Hydraulic intensifier for single-acting systems	HB443	3-Way 3-Position	9520*	Advance Hold Return	0-10 †	300-2,000 †	0-2.5
Single-Acting, Double-Acting	Hydraulic intensifier for double-acting systems	HB444	4-Way 3-Position	9506*	Advance Hold Return	0-10 †	300-2,000 †	0-2.5
Double-Acting	Hydraulic intensifier for double-acting torque wrench tools	HB445-RR	4-Way 3-Position	-	Advance Hold Return	0-10 †	300-2,000 †	0-2.5

† For maximum efficiency, recommended input flow is 5 gpm at a maximum pressure of 2,000 psi. Higher flows and/or pressures must be compensated for at the system pump (e.g., relief valve, variable flow devices, etc.)

* Posi-Check® valve design, Posi-Check® guards against pressure loss when valve is shifted from "advance" position to "hold" position.



CAUTION

This system should not be used for lifting applications.



Torque Wrench Pumps

For Torque Wrench Pumps, refer to the tool section.



CHOOSE YOUR BASIC PUMP, SELECT YOUR ACCESSORIES, AND WE WILL ASSEMBLE, TEST AND SHIP YOUR PUMP.

Pumps

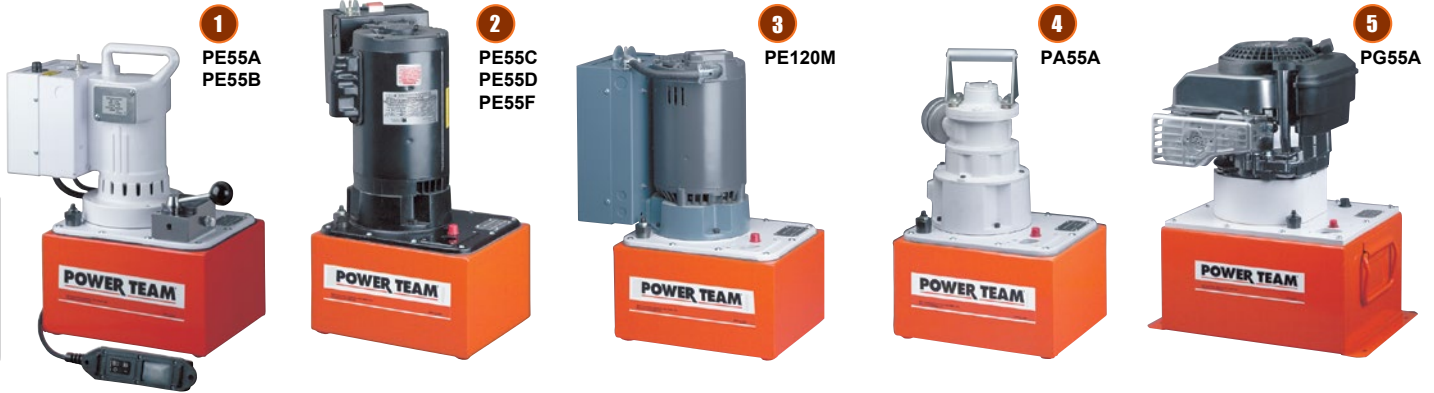

ORDER A “CUSTOM BUILT” HYDRAULIC PUMP

“Assemble to Order” means you can choose a basic pump with gas, air or electric motor. Then select the proper valve, gauge, pressure control, motor control and reservoir. You get a two-stage pump that gives high oil volume for fast cylinder approach (and return with double-acting cylinders) in the first stage and high pressure in the second stage.

1 1-1/8 HP UNIVERSAL MOTOR

These motors start under full load and are suitable for operation up to 5,000 or 10,000 psi. The motor is 1-1/8 hp, 12,000 rpm, 115 or 230VAC (specify), 50/60 cycle AC single-phase (25 amp draw at 115VAC). With proper valve they can be used with single or double-acting cylinders.

NOTE: Remote control available.

2 1-1/2 HP JET MOTOR, SINGLE & THREE-PHASE

Feature low noise level, moderate speed for long service and are ideal for fixed applications. Motor is 1-1/2 hp, 3,450 rpm, 115 or 230VAC, 50 or 60 cycle (specify), AC single-phase with thermal overload switch. Can be used with single or double-acting cylinders and equipped with remote control. Also available in 230/460VAC, three-phase (specify).

NOTE: These do not start under full load unless valve is in “neutral” (requires open or tandem center valve) and are not recommended for frequent starting and stopping.

3 3 HP JET MOTOR, THREE-PHASE

Gives low noise level and long life due to its moderate operating speed. Ideal for fixed installations. Consists of basic 10,000 psi pump, jet pump motor: 3 hp, 3,450 rpm, 230/460VAC, 60 or 50 cycle (specify). AC three-phase, with thermal overload switch. Equipped with internal and external relief valve. Will start under load.

4 3 HP AIR MOTOR

This pump is ideal for use where electricity is unavailable or cannot be used. The 5,000 or 10,000 psi pump has a 3 hp air-driven motor at 3,000 rpm (optimum performance based on 80 psi air pressure and 50 cfm at the pump). You can drive single or double-acting cylinders with the correct valve.

NOTE: 80 psi air supply required to start under full load.

5 GASOLINE ENGINE

This version is perfect when electricity and air are unavailable. It is capable of continuous operation at full pressure. Consists of basic 10,000 psi pump, 4-cycle Briggs & Stratton “Diamond Edge” gasoline engine, developing 6 hp. As with all these pumps, this unit can be valved for use with either single or double-acting cylinders.

Performance Specifications

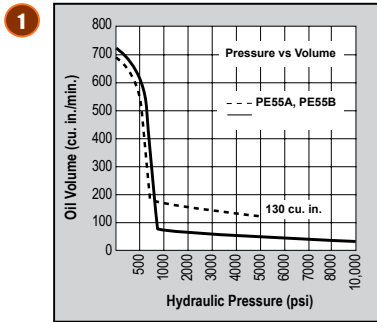

dBA @ Idle and 10,000 psi - 90/95
dBA @ Idle and 5,000 psi - 90/95

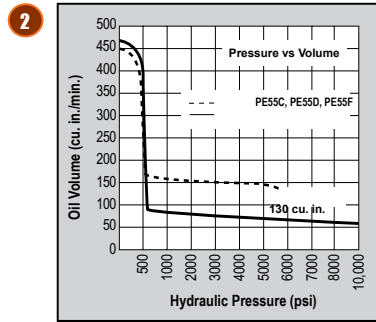

dBA @ Idle and 10,000 psi - 80/85

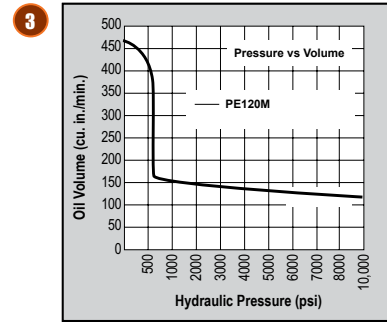

dBA @ Idle and 10,000 psi - 80/85

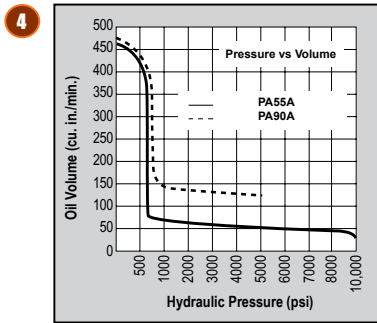

dBA @ Idle and 10,000 psi - 83/88
dBA @ Idle and 5,000 psi - 83/88

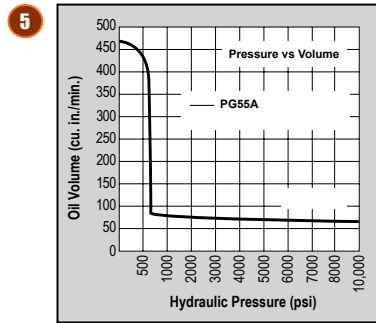

“ASSEMBLE TO ORDER” PUMP
HOW TO ORDER YOUR “CUSTOM” HYDRAULIC PUMP...

You can choose from pre-engineered, off-the-shelf components to customize your pump. All the components are listed in table form, with key letters or numbers on pages 109-110. Complete instructions guide you so

you can determine what is needed to complete a pump assembly. Shown below is an example of a custom-built pump.

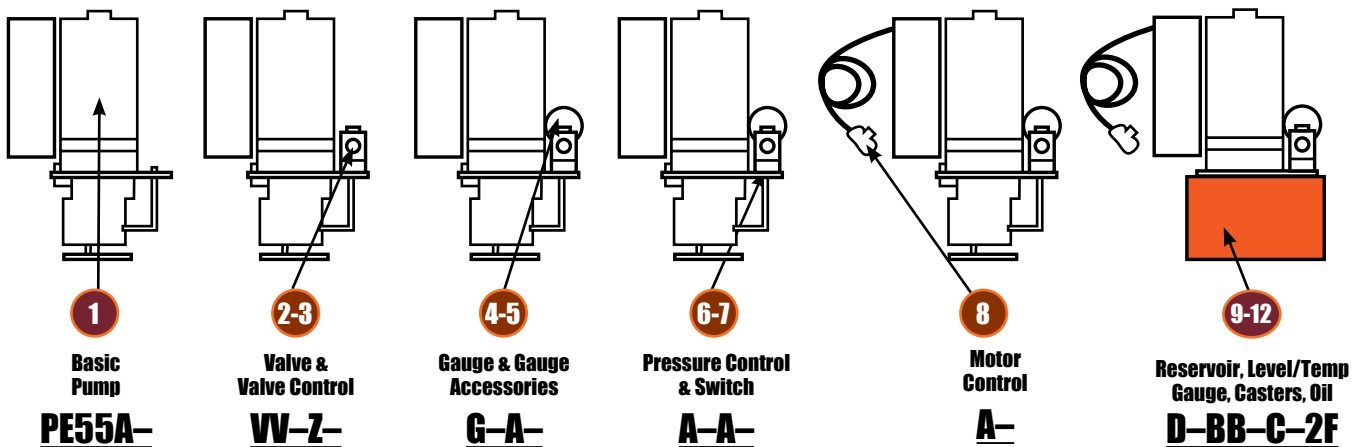

Pump No. PE55A-VV-Z-G-A-A-A-A-D-BB-C-2F is a 10,000 psi two-speed pump with a 115VAC, 50-60Hz, single-phase, 1-1/8 hp, 12,000 rpm motor; a 9512 4-way solenoid valve with a 202778 remote hand control, a 9041

pressure gauge, no gauge accessories, standard pressure control, standard On/Off/Pulse motor control, 40063OR9 2-gallon reservoir, a 350431 oil level/temperature gauge, 10494 casters, and 2 gallons of standard hydraulic oil.

See next two pages for pump components

TO BUILD YOUR PUMP, FILL IN KEY LETTERS FROM CHARTS

1 Basic Pump	2 Select Valve	3 Select Valve Control	4 Select Gauge	5 Select Gauge Accessory	6 Pressure Control
7 Pressure Switch	8 Motor Control	9 Reservoir	10 Oil Level / Temp. Gauge	11 Choose Casters	12 Select Oil

Use the charts numbered from 1-12 below to select the pump, valve, gauge and other accessories to suit your needs. For the pump, fill in the basic number plus key letter in block 1 above and the key letter only in the blocks 2-12 above for any of the other items. Refer to the appropriate pages in this catalog for more specific information on the products you need.

Pumps

1 BASIC PUMP

BASIC PUMP NUMBERS					SPECIFICATIONS			
PE55	PE120	PA55	PA90	PG55	NOTE: Customer must specify voltage required.			
(10,000 psi)	(10,000 psi)	(10,000 psi)	(5,000 psi)	(10,000 psi)	Power Source		rpm	hp
A					115VAC-60 Hz, 1Ø		12,000	1.125
					110VAC-50 Hz, 1Ø		12,000	1.125
B					230VAC-60 Hz, 1Ø		12,000	1.125
					220VAC-50 Hz, 1Ø		12,000	1.125
C **					115VAC-60 Hz, 1Ø		3,450	1.5
C50 **					110VAC-50 Hz, 1Ø		2,850	1.5
D **					230VAC-60 Hz, 1Ø		3,450	1.5
D50 **					220VAC-50 Hz, 1Ø		2,850	1.5
	M60 *				208, 230/460VAC-60 Hz, 3Ø		3,450	3
	M50 *				220/380VAC-50 Hz, 3Ø		2,850	3
		A	A		Air Motor		3,000	3
				A	Gas Engine		3,600	6

* Voltage Specification Required.

** These pumps do not start under full load unless valve is in "neutral" position (requires open or tandem center valve) and are not recommended for frequent starting and stopping.

2 VALVE

Manifold / Manual / Air-Operated Directional Valves	Function
AB 9628 manual, tandem center	4-way, 3-pos. valve
AC 9632 manual "twin" tandem and open center	4-way, 3-pos. valve
A None	—
B 9626 manifold	Manifold 3-way, 2-pos. valve
C 9584 manual	
D 9582 manual	
E 9610 automatic, pilot-operated	
G 9504 manual	3/4-way, 2-pos. valves
JJ 9594 air-operated	3-way, 3-pos. valve
L 9502 manual, closed center "non-interflow"	3-way, 3-pos. valve
M 9520 manual, tandem center Posi-Check®	3-way, 3-pos. valve

Manifold / Manual / Air-Operated Directional Valves	Function
O 9609 manual, pressure compensated flow control	3-way, 4-pos.
R 9506 manual, tandem center Posi-Check®	4-way, 3-pos. valves
RR 9511 manual, open center	
S 9500 manual, tandem center	
T 9507 manual, closed center Posi-Check®	
U 9501 manual, closed center	4-way, 3-pos. valves
Solenoid-Operated Directional Valves	
FF 9569 solenoid-operated - 24VAC	3-way, 2-pos.
HH 9572 solenoid-operated - 24VAC	3/4-way, 2-pos.
PP 9599 solenoid-operated - 24VAC	3-way, 3-pos.
VV 9512 solenoid-operated - 24VAC	4-way, 3-pos. valves
WW 9615 solenoid-operated - 24VAC	

3 VALVE CONTROL

Valve Remote Control	Use with Valve
A None	—
X 304718 remote hand control, 10 ft.	9572
XF 309652 remote foot control, 10 ft.	9572
Y 202777 remote hand control, 10 ft.	9569 or 9599

Valve Remote Control	Use with Valve
Z 202778 remote hand control, 10 ft.	9512 or 9615
ZF 309653 remote foot control, 10 ft.	9512, 9615, 9569 or 9599
ZZ 209593 remote hand control, 12 ft.	9594

4 GAUGE

Pressure Gauge	
A	None
B	Other – Specify
G	9041 0-10,000 psi – 0-689 Bar (2.5" diameter)
H	9040 0-10,000 psi – 0-689 Bar (Liquid) (2.5" diameter)
J	9051 0-10,000 psi – 0-689 Bar (4" diameter)
M	9052 0-10,000 psi – 0-689 Bar (Liquid) (4" diameter)

5 GAUGE ACCESSORY

Gauge Accessories	
A	None
N	9049 pulsation dampener – All dry gauges

6 PRESSURE CONTROL

Pressure Controls	
A	With standard external pressure regulator
C	Other – specify
D	350199 premium external pressure regulator. See Power Team Catalog product No. 9633 for details.

NOTE: Pressure controls are factory pre-set at 10,000 psi unless otherwise specified.

7 PRESSURE SWITCH

Pressure Switch	
A	None
B	9625 electric pressure switch (500-10,000 psi) NOTE: Pressure switch is factory pre-set at 10,000 psi unless otherwise specified.
C	9641 pilot-operated air control valve – Normally closed
D	9643 pilot-operated air control valve – Normally opened

8 MOTOR CONTROL

Electric Motor Controls	
A	Standard On/Off/Pulse control (does not include remote switch) for A, B, C, D, F and M electric pumps. Also used for remote controlled solenoid valves.
B	None
C	25017 remote motor hand switch, 10 ft.
D	203225 remote motor hand switch, 10 ft. (heavy-duty)
E	10461 remote motor foot switch, 10 ft.
Air Motor Controls	
AA	Other – specify
B	None
P	27876 hand motor control (for PA55 & PA90 series)
Q	27877 foot motor control (for PA55 & PA90 series)

9 RESERVOIR

Reservoir		Capacity
A	None	–
B	Other – Specify	–
D	40063OR9 – PE55, PE120, PA55 and PA90 series	2.5 gal.
E	61165† – PE55, PE120, PA55 and PA90 series (Oil temperatures in excess of 150° F. may cause permanent failure of the thermoplastic reservoir)	2 gal.
F	RP22‡ – PE55, PE120, PA55 and PA90 series	2.5 gal.
H	61799OR9. Same as D except with drain port	2.5 gal.
J	RP50 – PE55, PE120, PA55 and PA90 series	5 gal.
K	40137OR9 – PG55 series	5 gal.
P	209124 – PE55, PE120, PA55 and PA90 series	7 gal.
V	RP100 – PE55, PE120, PA55 and PA90 series	10 gal.
W	RP101 – PG55 series	10 gal.

NOTE: Includes cover adapter and misc. accessories when applicable.

† High density polyethylene.

‡ Aluminum.

10 OIL LEVEL / TEMP. GAUGE

Oil Level / Temperature Gauge	
A	None
BB	350431 oil level/temperature gauge

11 CASTERS

Casters	
A	None
BB	10494 caster for use with 40063OR9 reservoir (Specify quantity of four)

12 OIL

Hydraulic Oil		Capacity
E	Ship pump without oil	–
F	9637 Standard hydraulic oil	1 gal.
G	9638 Standard hydraulic oil	2.5 gal.
Q	9639 Flame-Out® hydraulic oil	1 gal.
R	9640 Flame-Out® hydraulic oil	2.5 gal.
U	9645 Biodegradable hydraulic oil	1 gal.
V	9646 Biodegradable hydraulic oil	2.5 gal.

NOTE: Select type of hydraulic oil and specify quantity.

HYDRAULIC ACCESSORIES



SELECT FROM A WIDE RANGE OF HYDRAULIC ACCESSORIES TO COMPLETE YOUR SYSTEM REQUIREMENTS

- Power Team offers the widest selection of pump-mounted, remote or in-line valves to control your hydraulic circuit requirements.
- A wide variety of hose types, sizes and configured arrangements in rubber or polyurethane
- High pressure fittings, gauges, and other miscellaneous accessories to fit your needs





	Section	Page Content	Pages
	Introduction	Choosing the Right Valve and Circuit Schematics	111-114
	Valves	Valve Selection / Pump Options Pump-Mounted Hydraulic Pump Accessories Remote-Mounted In-Line	115-116 117-124 125-126 127-128 129-131
	Fluids	Standard Hydraulic Oil, Flame Out®, Bio Degradable, Low Temperature	131
	Pump Accessories	Motor Controls, Sub-plates, Air Filter / Regulator / Lubricator, Pressure Switch, Air Control Valves, Oil Cooler Kits, Reservoir Breather Kits, Casters, Fluid Level / Temp. Gauge, Foot Control Guard, Magnetic Strip, Seal Kits, Carts / Roll Cages, Reservoirs	133-134
	Hoses	Rubber, Wire-Braid Polyurethane Non-Conductive	135-137
	Couplers	Quick-Connect, Flush Face	138
	Gauges	Heavy-Duty Hydraulic Digital and Analog	139-142
	Manifolds	Standard Blocks Blocks with Valves	143
	Fittings	Connectors, Couplings, Crosses, Elbows, Tees, Swivels, Special Adapters	144



SELECTING THE RIGHT VALVE:

Step 1: What is the tool requirement for valve control - single or double-acting?

Step 2: Determine how you intend to plumb the valve in hydraulic circuit - mounted or remote?

Step 3: How will you operate it - manual or remote? What type of directional control is needed?

VALVE SIZING CONSIDERATIONS:

- Will the valve be used with single or double-acting cylinders?
- Will the valve be mounted on the pump, away from the pump or directly into the hydraulic lines?
- Will the valve be manually-operated or is remote control preferred?



- Is independent control of multiple cylinders, or hydraulic tools preferred?
- What directional control and pressure control valve functions are needed for the application?

Note: Basic valve types include manually-operated, air or solenoid-operated and pilot-operated. Special application valves for pre-stressing and post-tensioning are also offered. Consult valve selection chart on pages 115-116 for listings of all Power Team valves.

DIRECTIONAL CONTROL VALVES



2-WAY, 2-POSITION

(FOR CONTROL OF SINGLE-ACTING CYLINDERS)

POSITION 1	CENTER POSITION	POSITION 2
 <p>Oil goes from pump to cylinder. Pressure is held from valve to cylinder when pump is shut-off.</p>	None	 <p>Oil goes from cylinder to pump. Pressure is released to reservoir when motor is turned off.</p>



3-WAY, 2-POSITION

(FOR CONTROL OF SINGLE-ACTING CYLINDERS)

POSITION 1	CENTER POSITION	POSITION 2
 <p>Oil goes from pump to cylinder and holds when pump is shut-off. Return line to reservoir is blocked.</p>	None	 <p>Cylinder retracts, oil returns to reservoir.</p>

3-WAY, 3-POSITION

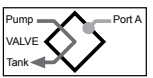
(FOR CONTROL OF SINGLE-ACTING CYLINDERS)

POSITION 1	CENTER POSITION	POSITION 2
 <p>Oil goes from pump to cylinder and holds when pump is shut-off. Return line to reservoir is blocked.</p>	 <p>Cylinder pressure is held. Pump can remain running and oil returns to reservoir.</p>	 <p>All oil is open to reservoir through return line.</p>



IN-LINE HYDRAULIC VALVES

Load-Lowering Valve – Provides precision metering for controlled return of the cylinder piston.

Sequence Valve – Used when a cylinder in a multiple cylinder application must advance before any other.

Pressure Reducing Valve – Permits independent pressure control to two or more, clamping systems operated by a single power source.

Shut-off Valve – For fine metering of hydraulic oil. Several may be used to control multiple single-acting cylinders.

Check Valve – Permits flow of hydraulic oil in one direction only.

Pressure Relief Valve – Used at remote locations in a hydraulic circuit where maximum pressure requirements are less than the setting of the basic overload valve in the pump. Protects a hydraulic system against over pressurization.

Metering Valve – Restricts surges by restricting flow to a certain level. When flow subsides, valve reopens automatically. For systems using large cylinders or extended lengths of hose.



Pressure Regulator Valve – Permits external adjustment of operating pressures at various values below the internal relief valve setting of the pump.

CAUTION: To prevent sudden, uncontrolled descent of a load as it is being lowered, use a 9596 Load-Lowering Valve or 9720 Counter Balance Valve in conjunction with the directional valve used in your application.

DIRECTIONAL CONTROL VALVES



4-WAY, 2-POSITION

(FOR CONTROL OF SINGLE-ACTING CYLINDERS)



POSITION 1	CENTER POSITION	POSITION 2
 <p>Oil goes to the "extend" side of the cylinder. The oil from the "retract" side returns to reservoir. Cylinder holds with pump shut-off.</p>	<p>None</p>	 <p>Oil goes to the "retract" side of the cylinder, oil from the "extend" side returns to reservoir.</p>

4-WAY, 3-POSITION

(FOR CONTROL OF DOUBLE-ACTING CYLINDERS)

POSITION 1	CENTER POSITION	POSITION 2
 <p>Oil goes to the "extend" side of the cylinder, oil from the "retract" side returns to reservoir. Cylinder holds with pump shut-off.</p>	 <p>Holds pressure even if pump is running. Oil from pump goes through valve, back to reservoir.</p>	 <p>Oil goes to "retract" side of cylinder. Oil from "extend" side returns to the reservoir.</p>

TYPICAL CENTERS

TANDEM CENTER	CLOSED POSITION	OPEN CENTER
 <p>Cylinder ports are blocked, oil from pump goes to reservoir. Used when pump remains running. Example: gasoline-driven pumps.</p>	 <p>Generally used when running multiple valves in series from one pump.</p>	 <p>Open Center used when holding is not a requirement, as when running two separate hydraulic tools such as cutters / crimpers.</p>

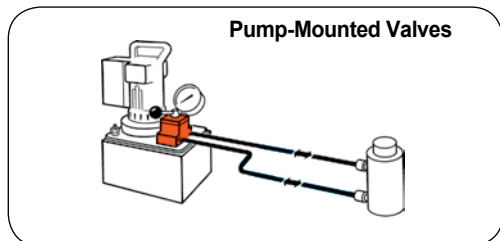

Order No.	Page No.	Cylinder* Applications	Operation	Valve Type	Volt	Advance / Return	Advance / Hold Return	**Posi-Check® Feature
9500	120	SA / DA	Manual	4-Way, 3-Pos. Tandem Center	—	No	Yes	No
9501	120	SA / DA	Manual	4-Way, 3-Pos. Closed Center	—	No	Yes	Yes
9502	119	SA	Manual	3-Way, 3-Pos. Closed Center	—	No	Yes	Yes
9504	118	SA / DA	Manual	3/4-Way, 2-Pos.	—	Yes	Yes	No
9506	120	DA	Manual	4-Way, 3-Pos. Tandem Center	—	No	Yes	Yes
9507	120	DA	Manual	4-Way, 3-Pos. Closed Center	—	No	Yes	Yes
9511	120	SA / DA	Manual	4-Way, 3-Pos. Open Center	—	Yes	Yes	No
9512	123	DA	Solenoid	4-Way, 3-Pos. Tandem Center	24	No	Yes	Yes
9513	123	DA	Solenoid	4-Way, 3-Pos. Tandem Center	115	No	Yes	Yes
9516	123	DA	Solenoid	4-Way, 3-Pos. Tandem Center	12	No	Yes	Yes
9517	118	SA	Manual	2-Way, 2-Pos.	—	No	Yes	No
9519	123	DA	Solenoid	4-Way, 3-Pos. Tandem Center	230	No	Yes	Yes
9520	119	SA	Manual	4-Way, 3-Pos. Tandem Center	—	No	Yes	Yes
9522	123	DA	Solenoid	4-Way, 3-Pos. Open Center	230	Yes	No	No
9523	123	SA	Pilot-Operated Solenoid	3-Way, 2-Pos.	230	Yes	No	No
9552	122	SA / DA	Solenoid	3/4-Way, 2-Pos.	230	Yes	No	No
9553	123	SA	Pilot-Operated Solenoid	3-Way, 2-Pos.	24	Yes	No	No
9569	122	SA	Solenoid	3-Way, 2-Pos.	24	No	Yes	No
9570	122	S.A.	Solenoid	3-Way, 2-Pos.	230	No	Yes	No
9572	122	SA / DA	Solenoid	3/4-Way, 2-Pos.	24	Yes	No	No
9579	122	SA	Solenoid	3-Way, 2-Pos.	115	No	Yes	No
9582	117	SA	Manual	3-Way, 2-Pos.	—	No	Yes	No
9584	117	SA	Manual	3-Way, 2-Pos.	—	No	Yes	No
9589	123	SA	Pilot-Operated Solenoid	3-Way, 2-Pos.	115	Yes	No	No
9590	123	DA	Solenoid	4-Way, 3-Pos. Open Center	115	Yes	No	No
9592	122	SA / DA	Solenoid	3/4-Way, 2-Pos.	115	Yes	No	No
9594	122	SA / DA	Air	3/4-Way, 2-Pos.	—	No	Yes	Yes
9599	121	SA	Pilot-Operated Solenoid	3-Way, 3-Pos. Tandem Center	24	No	Yes	Yes
9605	121	SA	Pilot-Operated Solenoid	3-Way, 3-Pos. Tandem Center	115	No	Yes	Yes
9609	121	SA	Manual	3-Way, 3-Pos. Tandem Center	—	No	Yes	No
9610	117	SA	Auto Pilot-Operated	3-Way, 2-Pos.	—	Yes	No	No
9610A	117	SA	Manual	2/3-Way, 2-Pos.	—	No	Yes	No
9615	123	DA	Solenoid	4-Way, 3 Pos. Open Center	24	Yes	No	No
9628	124	SA / DA	Manual	Post-Tensioning	—	Special	No	No
9632	124	SA / DA	Manual	Post-Tensioning	—	Special	No	No

Note:

* "SA" represents single-acting cylinders and "DA" represents double-acting cylinders.

** The Posi-Check® feature guards against pressure loss when shifting from "advance" to "hold" position.

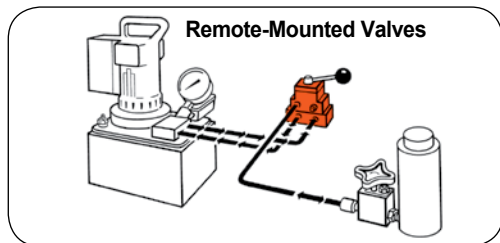

Order No.	Page No.	Cylinder Applications*	Operation	Valve Type	Volt	Advance / Return	Advance / Hold Return	**Posi-Check® Feature
9508	128	SA / DA	Manual	4-Way, 3-Pos. Closed Center	—	No	Yes	Yes
9509	128	SA / DA	Manual	4-Way, 3-Pos. Tandem Center	—	No	Yes	Yes
9514	128	DA	Solenoid	4-Way, 3-Pos. Tandem Center	115	No	Yes	Yes
9524	127	SA / DA	Solenoid	3/4-Way, 2-Pos.	230	No	Yes	No
9525	128	DA	Solenoid	4-Way, 3-Pos. Tandem Center	230	No	Yes	Yes
9526	128	SA	Solenoid	3-Way, 2-Pos.	230	No	Yes	No
9554	127	SA / DA	Solenoid	3/4-Way, 2-Pos.	24	No	Yes	No
9555	128	DA	Solenoid	4-Way, 3-Pos. Tandem Center	24	No	Yes	Yes
9556	128	SA	Solenoid	3-Way, 2-Pos.	24	No	Yes	No
9559	128	SA	Solenoid	3-Way, 2-Pos.	115	No	Yes	No
9593	127	SA / DA	Solenoid	3/4-Way, 2-Pos.	115	No	Yes	No
9595	127	SA / DA	Air	3/4-Way, 2-Pos.	—	No	Yes	No

Note:

* "SA" represents single-acting cylinders and "DA" represents double-acting cylinders.

** The Posi-Check® feature guards against pressure loss when shifting from "advance" to "hold" position.

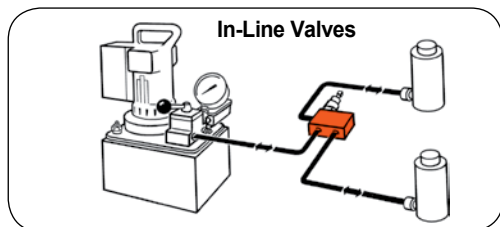

Order No.	Page No.	Cylinder Applications*	Operation	Valve Type
9575	131	SA	Manual	Shut-Off Valve
9580	131	SA	Automatic	One-Way Check Valve
9581	131	SA / DA	Automatic	Pilot-Operated Check Valve
9596	129	SA	Manual	Load-Lowering Valve
9597	129	SA / DA	Automatic	Sequence Valve
9608	129	SA / DA	Automatic	Pressure Reducing Valve
9623	131	SA / DA	Automatic	Pressure Relief Valve
9631	130	SA / DA	Automatic	Metering Valve
9633	130	SA / DA	Automatic	Pressure Regulator Valve
9720	129	SA / DA	Automatic	Counter Balance Valve
9721	129	SA / DA	Automatic	Counter Balance Valve
RV21278	130	—	Automatic	Relief Valve

Note:

* "SA" represents single-acting cylinders and "DA" represents double-acting cylinders.

3-WAY / 2-POSITION MANUAL VALVES

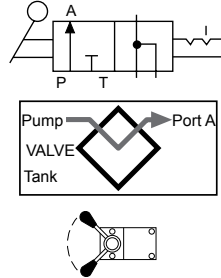
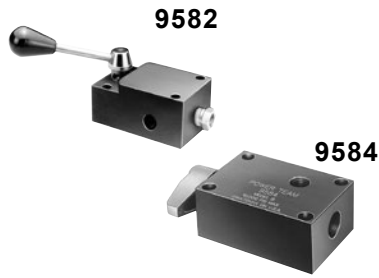

Applications: Single-acting cylinders.
Actuation: Lever-operated.
Functions: Cylinder piston "advance," "hold" and "return."
Used on these pumps: P460, PE17, PE21, PE30, PE46, PE55, and PE120 series.

Order No.	Description
9582	3-Way/2-Position manual valve. Wt., 2.5 lbs.
9584	3-Way/2-Position manual valve "flipper" control. Wt., 1.8 lbs.

Accessories

3-WAY / 2-POSITION PILOT-OPERATED AUTOMATIC VALVES

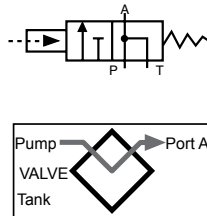

Applications: Single-acting cylinders.
Actuation: Pilot oil.
Functions: When pump is started, pilot oil automatically closes valve and directs oil to cylinder. When pump is stopped, valve automatically opens and oil returns to reservoir.
Used on these pumps: Furnished with pilot lines and adapters for PA55, PA90, PE30, PE55, and PE120 series.

Order No.	Description
9610	3-way/2-position pilot-operated automatic valve. Wt., 4.2 lbs.

2/3-WAY/2-POSITION MANUAL/PILOT-OPERATED AUTOMATIC VALVE

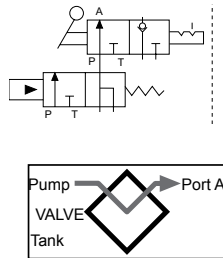

Applications: Manual operation for load lifting and holding with single-acting cylinders; automatic "dump" for operating hydraulic tools.
Actuation: Flipper lever/pilot oil.
Functions: With lever in closed position, valve will hold the load. When lever is "open," valve functions as a true automatic "dump" valve..
Used on these pumps: Furnished with pilot lines and adapters for PA55, PA90, PE30, PE55, and PE120 series. For application on other pumps, consult factory.

Order No.	Description
9610A	2/3-way/2-position manual/pilot-operated automatic valve. Wt., 4.4 lbs.

CAUTION: To prevent sudden, uncontrolled descent of a load as it is being lowered, use a 9596 Load-Lowering Valve or 9720 Counter Balance Valve in conjunction with the directional valve used in your application.
IMPORTANT: Conversion kit 251528 must be used when mounting any of the valves on this page on PA17 or PE17 pumps.
IMPORTANT: When ordering any valve for a PE30 or PG30 series pump, 1/2" longer mounting screws are required. For valves 9504, 9584, 9610 and 9610A, order four 12001 cap screws. For valve 9582, order two 12001 and two 10856 cap screws.

2-WAY/2-POSITION MANUAL VALVE

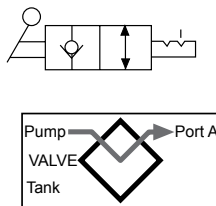

Applications: Single-acting cylinders.
Actuation: Flipper lever-operated.
Functions: Cylinder piston "advance," "hold" and "retract."
Used on these pumps: PE172 and PA172.

Order No.	Description
9517	2-way/2-position manual valve. Wt., 3.2 lbs.

3/4-WAY/2-POSITION MANUAL VALVE

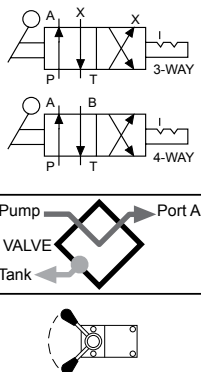

Applications: Single or double-acting cylinders.
Actuation: Lever-operated, detent-positioned.
Functions: Pos. 1 – Oil is directed to "advance" side of cylinder, oil from "retract" side goes to reservoir, cylinder "holds" with pump shut-off. Pos. 2 – Oil goes to "retract" side of cylinder, cylinder "holds" with pump shut-off. When using as a 3-way valve for single-acting cylinders, port "A" or "B" is plugged. See note below regarding plugging of ports and resulting heat build-up..
Used on these pumps: P460, PA6D, PA17, PA46, PA55, PA60, PE17, PE21, PE30, PE46, PE55, PE120, PE400, PQ60 and PQ120 series.

Order No.	Description
9504	3/4-way/2-position manual valve. Wt., 4.2 lbs.

NOTE: 9504 can be remote-mounted with a 9510 sub-plate.

CAUTION: To prevent sudden, uncontrolled descent of a load as it is being lowered, use a 9596 Load-Lowering Valve or 9720 Counter Balance Valve in conjunction with the directional valve used in your application.

IMPORTANT: Conversion kit 251528 must be used when mounting any of the valves on this page on PA17 or PE17 pumps.

IMPORTANT: When ordering any valve for a PE30 or PG30 series pump, 1/2" longer mounting screws are required. For valves 9504, 9584, 9610 and 9610A, order four 12001 cap screws. For valve 9582, order two 12001 and two 10856 cap screws.

NOTE: Valves 9501, 9502, 9504 and 9507 can have a port blocked or have a closed center position. When a port is blocked and the valve is shifted to the blocked port, the pump will generate excessive heat. An electric or rotary air pump can either be turned off manually or with a pressure switch. Reciprocating air pumps may be adjusted to stall out and stop.

Accessories

3-WAY/3-POSITION (CLOSED CENTER) NON-INTER FLOW MANUAL VALVE WITH POSI-CHECK®

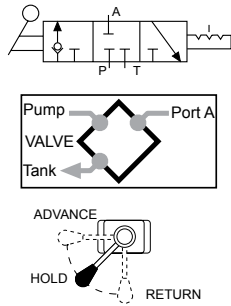

Applications: Single-acting cylinders.

Actuation: Lever-operated, detent-positioned.

Functions: Pos. 1 – Oil is directed from pump to cylinder and “holds” with pump shut-off, line to reservoir is blocked. Pos. 2 – All oil is open to reservoir through tank line. Center Pos. – Cylinder pressure is held, and pump should be shut-off.

Used on these pumps: P460, PA17, PA46, PA55, PA60, PE17, PE21, PE30, PE46, PE55, PE120, PE400, PQ60 and PQ120 series.

Order No.	Description
9502	3-way/3-position (closed center) manual valve. Wt., 4.2 lbs.

NOTE: A pressure switch and/or gauge may be attached if desired. Also, the 9502 can be remote-mounted if a 9510 sub-plate is used.

Accessories

3-WAY/3-POSITION (TANDEM CENTER) MANUAL VALVE WITH POSI-CHECK® VALVE

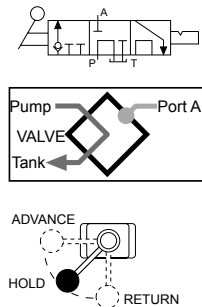

Applications: Single-acting cylinders.

Actuation: Lever-operated, detent-positioned.

Functions: “Advance,” “hold” and “return.” When shifted to “return” position, pump and cylinder return oil through their own separate return lines, allowing faster retraction of piston. The Posi-Check® feature guards against pressure loss when shifting from “advance” to “hold” position.

Used on these pumps: P460, PA17, PA46, PA55, PE17, PE21, PE30, PE46, PE55, PE120, PQ60, PQ120, PE400, PG30, PG55, PG120 and PG400 series.

Order No.	Description
9520	3-way/3-position (tandem center) manual valve. Wt., 5.1 lbs.

CAUTION: To prevent sudden, uncontrolled descent of a load as it is being lowered, use a 9596 Load-Lowering Valve or 9720 Counter Balance Valve in conjunction with the directional valve used in your application.

NOTE: Valves 9501, 9502, 9504 and 9507 can have a port blocked or have a closed center position. When a port is blocked and the valve is shifted to the blocked port, the pump will generate excessive heat. An electric or rotary air pump can either be turned off manually or with a pressure switch. Reciprocating air pumps may be adjusted to stall out and stop.

NOTE: Gauge ports monitor pump pressure only, not pressure to the hydraulic cylinder(s).

NOTE: Conversion kit 251528 must be used when mounting any of the valves on this page on PA17 or PE17 pumps.

IMPORTANT: When ordering any valve for a PE30 or PG30 series pump, 1/2" longer mounting screws are required. For valves 9502 and 9520, order four 12001 cap screws. For valve 9576, order four 17428 cap screws.

4-WAY/3-POSITION (TANDEM CENTER) VALVE WITH POSI-CHECK®

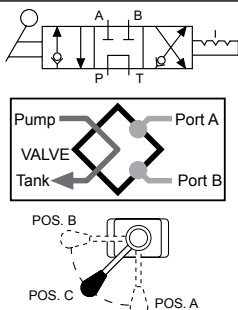

Applications: Single or double-acting cylinders.

Actuation: Lever-operated, detent-positioned.

Functions: "Advance," "hold" and "return." The Posi-Check® feature guards against pressure loss when shifting from "advance" to "hold" position.

Used on these pumps: P460, PA6D, PA17, PA46, PA55, PE17, PE21, PE30, PE46, PE55, PE84, PE120, PE400, PED, PG30, PG55, PG120, PG400, PQ60 and PQ120 series.

Order No.	Description
9506	4-way/3-position (tandem center) manual valve. Wt., 5.1 lbs.

4-WAY/3-POSITION (TANDEM CENTER) AND (OPEN-CENTER) MANUAL VALVES

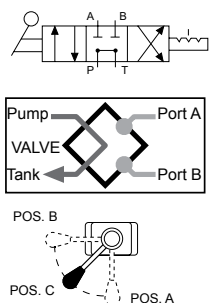

Applications: Single or double-acting cylinders.

Actuation: Lever-operated, detent-positioned.

Functions: The 9500 provides "advance," "hold" and "return." The 9511 (open center) valve can be used if holding is not a requirement, as when running two separate hydraulic tools. Provides "advance" and "return" only.

Used on these pumps: P460, PA17, PA46, PA55, PE17*, PE21, PE30, PE46, PE55, PE120, PE400, PG30, PG55, PG120, PG400, PQ60 and PQ120 series.

*Does not mount without 251528.

Order No.	Description
9500	4-way/3-position (tandem center) manual valve. Wt., 4.2 lbs.
9511	4-way/3-position (open center) manual valve. Wt., 4.2 lbs.

4-WAY/3-POSITION (CLOSED CENTER) MANUAL VALVE WITH POSI-CHECK®

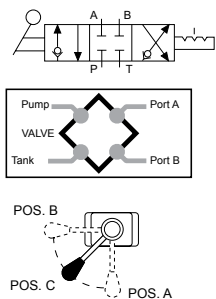

Applications: Single or double-acting cylinders.

Actuation: Lever-operated, detent-positioned.

Functions: Similar to 9506, but is a closed center valve with Posi-Check®. Generally used to operate multiple cylinders with a single pump. Provides "advance," "hold" and "return." The Posi-Check® feature guards against pressure loss when shifting from the "advance" to "hold" position. See note below regarding plugging of ports and resulting heat build-up.

Used on these pumps: P460, PA17, PA46, PA55, PA60, PA6D, PE17, PE21, PE30, PE46, PE55, PE120, PE400, PQ60 and PQ120 series.

Order No.	Description
9507	4-way/3-position (closed center) manual valve. Wt., 5 lbs.

4-WAY/3-POSITION (CLOSED CENTER) MANUAL VALVE

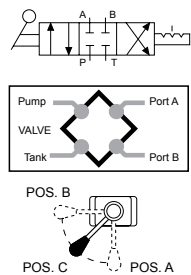
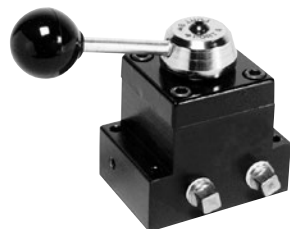

Applications: Single or double-acting cylinders.

Actuation: Lever-operated, detent-positioned.

Functions: "Advance," "hold" and "return." Closed center design makes valve suitable for operating multiple cylinders from a single pump. See note below regarding plugging of ports and resulting heat build-up.

Used on these pumps: P460, PA17, PA46, PA55, PA60, PE17, PE21, PE30, PE46, PE55, PE120, PE400, PQ60 and P120 series.

Order No.	Description
9501	4-way/3-position (closed center) valve. Wt., 4.2 lbs.

NOTE: All valves on this page may be remote-mounted with a 9510 sub-plate. Valves 9501, 9502, 9504 and 9507 can have a port blocked or have a closed center position. When a port is blocked and the valve is shifted to the blocked port, the pump will generate excessive heat. An electric or rotary air pump can either be turned off manually or with a pressure switch. Reciprocating air pumps may be adjusted to stall out and stop.

Accessories

3-WAY/3-POSITION (TANDEM CENTER) SOLENOID VALVES WITH POSI-CHECK®

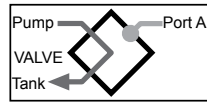
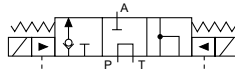
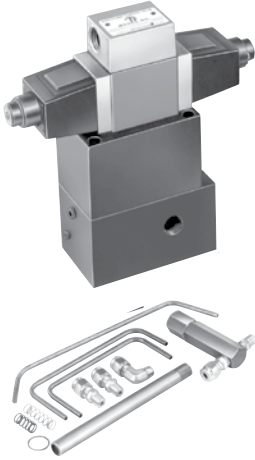

Applications: Single-acting cylinders.

Actuation: Solenoid-operated: 9605 is 115VAC, 50/60 Hz; 9599 is 24VAC, 50/60 Hz.

Functions: "Advance," "hold" and "return" positions. When in "advance," solenoid "B" is energized and oil goes from pump to cylinder through pressure port. In "return" position, solenoid "A" is energized and oil is directed from cylinder and pump to reservoir. With both solenoids de-energized, in "hold" position, oil from pump is directed back to reservoir while oil is checked in cylinder. The Posi-Check® feature holds load when shifting from "advance" to "hold" position.

Used on these pumps: Furnished with pilot lines and adapters for PE55, PE30 (carrying handles must be removed) and PE120 series. For application on other models, consult factory.

Order No.	Description
9605	3-way/3-position (tandem center) solenoid valve, 115VAC, 50/60 Hz. Wt., 14.0 lbs.
9599	3-way/3-position (tandem center) solenoid valve, 24VAC, 50/60 Hz. Wt., 14.0 lbs.

NOTE: Valves above are shipped without controls. Use 202777 remote hand control. Consult factory for field installation.

Accessories

3-WAY/4-POSITION MANUAL PRESSURE COMPENSATED VALVE

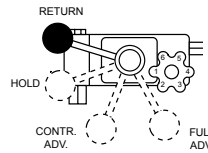
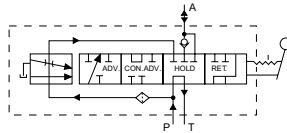
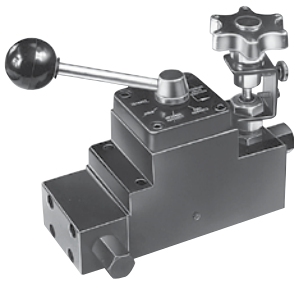

Applications: Single-acting cylinders. Primarily for use in testing soil, rock, concrete, asphalt and related engineering materials.

Actuation: Lever and adjustable, pressure compensated flow control valve.

Functions: Cylinder piston "return," "hold," "controlled advance" (pressure compensated) and "advance" (full flow). Will deliver a relatively constant flow regardless of pressure between 1,000 and 10,000 psi.

Used on these pumps: PA17, PA46, PA55, PE17, PE21, PE30*, PE46, PE55, PE200, PE400, PG30*, PG55, PG120, PG400, PQ60 and PQ120 series. * NOTE: Adapter kit 252161 is required for mounting this valve to a PE30 or PG30 series pump.

Order No.	Description
9609	3-way/4-position manual pressure compensated valve. Wt., 8.7 lbs.



PRESSURE COMPENSATED VALVE PERFORMANCE CHART

FLOW

Full flow position - 5 gpm (Ref.)
Metered advance position
65 cu. in./min. (Max.)

PRESSURE

Min. working pressure - 1,000 psi.
Max. working pressure - 10,000 psi.
Max. valve case pressure - 500 psi.

Chart to the right reflects valve performance when "metered advance" position is selected.

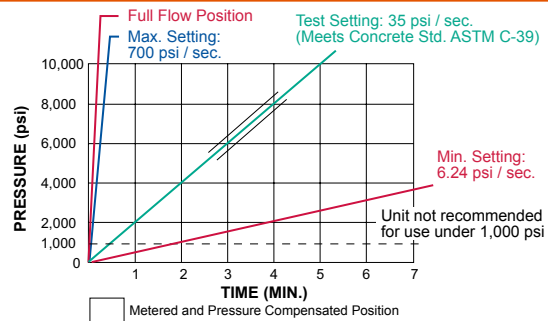

CAUTION: To prevent sudden, uncontrolled descent of a load as it is being lowered, use a 9596 Load-Lowering Valve or 9720 Counter Balance Valve in conjunction with the directional valve used in your application.

IMPORTANT: Conversion kit 251528 must be used when mounting the 9609 valve on PA17 or PE17 pumps.

IMPORTANT: When ordering any valve for a PE30 or PG30 series pump, 1/2" longer mounting screws are required. For valves 9500, 9501 and 9511, order four 12001 cap screws. For valve 9552, 9506, and 9507, order four 11956 cap screws. For valves 9599 and 9605, order four 251078 cap screws. For valve 9609, order four 10855 cap screws.

3-WAY/2-POSITION SOLENOID VALVE

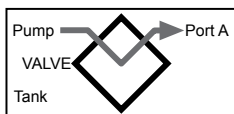
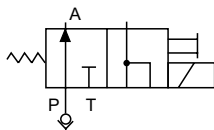

Applications: Single-acting cylinders.

Actuation: Solenoid-operated, 115VAC, 50/60 Hz.

Functions: Cylinder piston advances when solenoid is de-energized and pump is running. When solenoid is energized, oil is directed to reservoir, and piston returns. For "hold" position, pump is stopped with solenoid de-energized.

Used on these pumps: PE17, PE21, PE30, PE46, PE55, PE120, PE400, PQ60 and PQ120 series.

Order No.	Description
9579	3-way/2-position solenoid valve, 115VAC, 50/60 Hz., Wt. 9.6 lbs.
9569	3-way/2-position solenoid valve, 24VAC, 50/60 Hz., Wt. 9.6 lbs.
9570	3-way/2-position solenoid valve, 230VAC, 50/60 Hz., Wt. 9.6 lbs.

NOTE: Valves above are shipped without control switch. Use 202777 remote hand switch. When this valve is mounted, the pump must be equipped with an outlet check valve.

3/4-WAY/2-POSITION SOLENOID VALVES

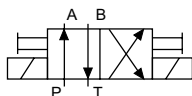

Applications: Single or double-acting cylinders. When used with single-acting cylinders, one port should be plugged.

Actuation: Solenoid-operated, 115VAC, 50/60 Hz.

Functions: Oil is directed to "extend" side of cylinder, oil from "retract" side goes to reservoir; cylinder "holds" with pump shut-off. Oil is directed to "retract" side of cylinder; oil from "extend" side goes to reservoir. **NOTE:** Cylinder will not "hold" in the "return" position with motor running or shut-off.

Used on these pumps: 9552, 9572 and 9592 are used with PE17, PE30 (with carrying handles removed), PE46, PE55, PE400, PQ60 and PQ120 series.

Order No.	Description
9592	3/4-way/2-position solenoid valve, 115VAC, 50/60 Hz., Wt. 14.6 lbs.
9552	3/4-way/2-position solenoid valve, 230VAC, 50/60 Hz., Wt. 14.6 lbs.
9572	3/4-way/2-position solenoid valve, 24VAC, 50/60 Hz., Wt. 14.6 lbs.

NOTE: Valves above are shipped without controls. The 9552, 9572 and 9592 can be used with the 304718 remote hand control.

NOTE: Ports are 1/4" NPTF.

AIR ACTUATED VALVE

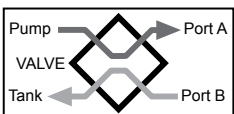
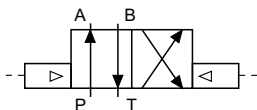

Applications: Single or double-acting cylinders. When used with single-acting cylinders, one port should be plugged.

Actuation: Air-operated.

Functions: Oil is directed to "extend" side of cylinder, oil from "retract" side goes to reservoir, cylinder "holds" with pump shut-off. Oil is directed to "retract" side of cylinder, oil from "extend" side goes to reservoir.

NOTE: Cylinder will not "hold" in the "return" position with motor running or shut-off.

Used on these pumps: PA17, PA46 and PA55 series.

Order No.	Description
9594	3/4-way/2-position solenoid valve, air-operated (minimum of 50 psi air pressure required). Wt., 11 lbs.

NOTE: Valve above is shipped without controls. 9594 can be used with the 209593 remote hand control.

CAUTION: To prevent sudden, uncontrolled descent of a load as it is being lowered, use a 9596 Load-Lowering Valve or 9720 Counter Balance Valve in conjunction with the directional valve used in your application.

IMPORTANT: Conversion kit 251528 must be used when mounting any of the valves on this page on PA17 or PE17 pumps.

IMPORTANT: When ordering any valve for a PE30 or PG30 series pump, 1/2" longer mounting screws are required. For valves 9569, 9570 and 9579, order four 10856 cap screws. For valves 9552, 9572 and 9592, order four 12001 cap screws.

Accessories

4-WAY/3-POSITION (OPEN CENTER) SOLENOID VALVE

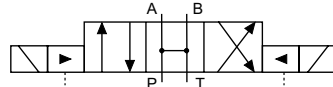
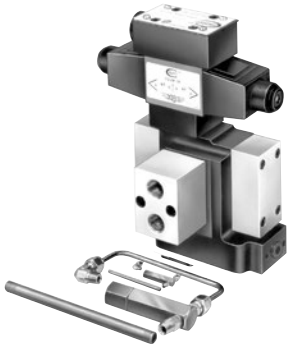

Applications: Double-acting cylinders.

Actuation: Solenoid-operated, 115VAC, 50/60 Hz.

Functions: "Advance," open center and "return" positions. Cylinder ports and pump port are open to reservoir in "neutral."

Used on these pumps: Furnished with pilot lines and adapters for PE30 (with carrying handles removed), PE55 and PE120 series. For other pump models, consult factory.

NOTE: A pressure switch and/or gauge may be attached if desired.

Order No.	Description
9590	4-way/3-position (open center) solenoid valve, 115 volt, 50/60 Hz., Wt. 15.5 lbs.
9522	4-way/3-position (open center) solenoid valve, 230 volt, 50/60 Hz., Wt. 15.5 lbs.
9615	4-way/3-position (open center) solenoid valve, 24 volt, 50/60 Hz., Wt. 15.5 lbs.

Accessories

4-WAY/3-POSITION (TANDEM CENTER) PILOT-OPERATED SOLENOID VALVE

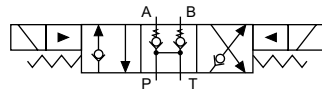

Applications: Double-acting cylinders.

Actuation: Solenoid-operated, 115VAC, 50/60 Hz.

Functions: "Advance," "hold" and "return." The Posi-Check® feature holds the load when shifting from the "advance" to the "hold" position.

Used on these pumps: PE17, PE21, PE30 (with carrying handles removed), PE46, PE55, PE120, PE400, PQ60 and PQ120 series.

NOTE: A gauge may be attached if desired.

Order No.	Description
9513	4-way/3-position (tandem center) solenoid valve, 115VAC, 50/60 Hz., Wt. 18.1 lbs.
9512	4-way/3-position (tandem center) solenoid valve, 24VAC, 50/60 Hz., Wt. 18.1 lbs.
9516	4-way/3-position (tandem center) solenoid valve, 12VDC, Wt. 18.1 lbs. For use on the PG1204S and PG400 series pumps only.
9519	4-way/3-position (tandem center) solenoid valve, 230VAC, 50/60 Hz., Wt. 18.1 lbs. Consult factory for field installation.

3-WAY/2-POSITION (PILOT-OPERATED, NORMALLY OPEN) SOLENOID VALVE

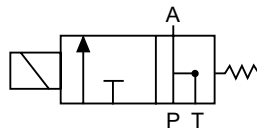

Applications: Single-acting cylinders.

Actuation: Solenoid-operated, 115VAC, 50/60 Hz.

Functions: "Advance" and "return."

Used on these pumps: Furnished with pilot lines and adapters for PE30 (with carrying handles removed), PE55 and PE120 series. For other pump models, consult factory.

NOTE: A pressure switch and/or gauge may be attached if desired.

Order No.	Description
9589	3-way/2-position (pilot-operated) solenoid valve, 115VAC, 50/60 Hz., Wt. 8.2 lbs.
9523	3-way/2-position (pilot-operated) solenoid valve, 230VAC, 50/60 Hz., Wt. 8.2 lbs.
9553	3-way/2-position (pilot-operated) solenoid valve, 24VAC, 50/60 Hz., Wt. 8.2 lbs.

CAUTION: To prevent sudden, uncontrolled descent of a load as it is being lowered, use a 9596 Load-Lowering Valve or 9720 Counter Balance Valve in conjunction with the directional valve used in your application.

IMPORTANT: Conversion kit 251528 must be used when mounting the 9609 valve on PA17 or PE17 pumps.

IMPORTANT: When ordering any valve for a PE30 or PG30 series pump, 1/2" longer mounting screws are required. For valves 9513 and 9519, order four 11956 cap screws.

For valves 9523, 9553 and 9589, order four 10855 cap screws. For valves 9522, 9590 and 9615, order four 10854 cap screws.

NOTE: Valves above are shipped without control switch.

4-WAY/3-POSITION (TANDEM CENTER) MANUAL VALVE



Designed for use with Power Team air, gasoline and electric powered hydraulic pumps.

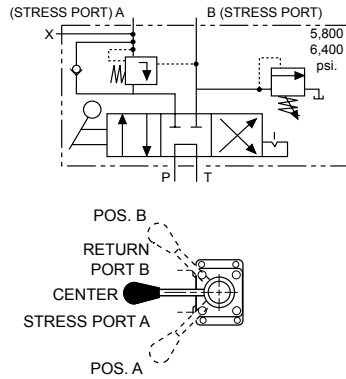

Applications: Single strand, double-acting stressing jacks with Power Wedge seater.

Actuation: Lever-operated, detent-positioned.

Operation:

1. With valve in center position, pump is started.
2. Cable is inserted into stressing tool, valve is placed in "A" position. "Pull" portion of stressing tool is pressurized to specified level for proper cable tensioning ("A" port is checked internally, can only be released by building pressure in "B" position).
3. Valve is placed in "B" position, which is pressure controlled and will not exceed 6,400 psi. "Return" portion of stressing tool is pressurized and will release "A" port when pressure reaches approximately one-half the "A" port pressure. "A" port remains open as long as this pressure differential is maintained.
4. Pump is stopped, valve is placed in "A" position, releasing "B" port pressure.

Used on these pumps: PA17*, PA46*, PA55, PE17*, PE21*, PE30, PE46*, PE55, PE60, PE120, PE400, PG30*, PG55, PG120, PG400, PQ60 and PQ120 series.

* These pumps may have reduced first flow stage characteristics due to internal valve restrictions.

Order No.	Description
9628	Post-tensioning valve for 10,000 psi (max.) single-acting/Power Wedge seater. Wt., 5.4 lbs.

Accessories

"TWIN" 4-WAY/3-POSITION (TANDEM CENTER) MANUAL VALVE

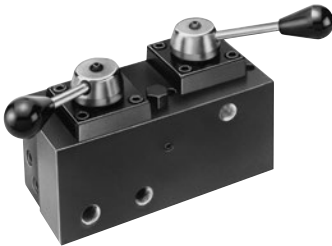

Pump-mounted, 6-position detented 5-way manual dual valve. Rated pressure to valve "A" is 10,000 psi and valve "B" is 6,000 psi. Case pressure is 500 psi max.

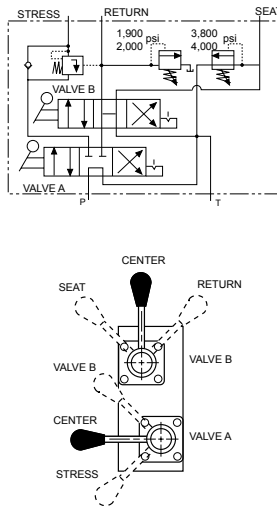

Applications: Multi-strand, double-acting stressing jacks with an auxiliary seating cylinder.

Actuation: Dual lever-operated, detent-positioned.

Operation:

1. With valves "A" and "B" in center position, pump is started, and cable is inserted into stressing tool.
2. Valve "A" is placed in "Stress" position and cylinder extends to tension cable. Pump pressure controls force exerted by tensioning cylinder in this position. "Stress" port is checked internally, and can only be released by building pressure in the valve "B" return position.
3. When desired cable tension is achieved, valve "A" is placed in valve "B" position and valve "B" in "Seat" position. Seating portion of cylinder will be pressurized to seating pressure controlled by "Seat" relief valve (factory set to 3,900 psi).
4. Valve "B" is shifted to "Return" position, which is pressure controlled and will not exceed 2,200 psi. "Return" portion of stressing tool should be pressurized and will release "Stress" port when pressure reaches 15% of "Stress" port pressure.
5. "Stress" port will remain open and cylinder will return as long as pressure differential is maintained. "Stress" and "Seat" ports are open to reservoir.
6. When cylinder has fully returned, both valves are shifted to "Center" position and oil will be directed to reservoir. Maximum pressure setting for the "Seat" relief valve is 6,000 psi.

Used on these pumps: PA17*, PA46*, PA55, PE17*, PE21*, PE30, PE46*, PE55, PE120, PE400, PG30*, PG55, PG120, PG400, PQ60 and PQ120 series.*

* These pumps may have reduced first flow stage characteristics due to internal valve restrictions.

Order No.	Description
9632	Post-tensioning valve for 10,000 psi (max.) double-acting systems. Wt., 13.6 lbs.

CAUTION: To prevent sudden, uncontrolled descent of a load as it is being lowered, use a 9596 Load-Lowering Valve or 9720 Counter Balance Valve in conjunction with the directional valve used in your application.

IMPORTANT: Conversion kit 251528 must be used when mounting any of the valves on this page on PA17 or PE17 pumps.

IMPORTANT: When ordering any valve for a PE30 or PG30 series pump, 1/2" longer mounting screws are required. For valves 9569, 9570 and 9579, order four 10856 cap screws. For valves 9552, 9572 and 9592, order four 12001 cap screws.

OIL COOLER KITS

	Order No.	Description
	252511	Oil cooler kit designed for use with PE604T or PE604PT pumps with 115VAC. Wt., 5.0 lbs.
	252512	Oil cooler kit designed for use with PE604T or PE604PT pumps with 220VAC. Wt., 5.0 lbs.

FLUID LEVEL/TEMPERATURE GAUGE

	Displays fluid level and temperature of hydraulic oil in reservoir. 32°- 212° F, 0°- 100° C. 1.25" wide and 6.38" high.	
	Order No.	Description
	350431	Fluid level/temperature gauge.

RESERVOIR BREATHER KITS

	Order No.	Description
	206767	Reservoir breather kit designed for use on PA17, PA55, PE17, PE55, PE120, PG55, PG120, PQ60 and PQ120 series pumps. Wt., 1.3 lbs.
	250175	Reservoir breather kit designed for use on PE21 and PE46 series pumps. These kits replace the reservoir filler cap when the pump is used in dusty and dirty environments. Wt., 1.3 lbs.

CASTERS

	2" diameter casters attach to the bottom of large reservoir for portability. Sold individually. Order the amount required.	
	Order No.	Description
	10494	Single caster wheel. Wt., 0.3 lb.

FOOT CONTROL GUARD

	Order No.	Description
	16339	Foot Guard for use with 10461 and 251660 foot controls.

MAGNETIC STRIP

	Order No.	Description
	207762	Magnetic strip with adhesive back can be added to No. 25017, 202777, 202778 and 304718 hand controls. Provides 6 lbs. of holding force. Wt., 0.1 lb.

VITON™ * SEAL KITS



Viton™* seal kits Can be used in all "C" and "RH" series cylinders, as well as the P12, P55, P59, P157/ P159, P157D/P159D and P300/P300D series of hand pumps. These seals are required when fire resistant hydraulic fluids are used. Not required with Flame-Out® fluid.

Order No.	Use With	Model
300507	P12	All
300472	P23, P55	All
300510	P59	All
300508	P157, P159, P300	A
300690	P157, P159	B
300696	P300	B
300508	P157D, P159D, P300D	A
300693	P157D, P159D	B
300699	P300D	B

* Viton™ is an trademarks or registered trademarks of The Chemours Company

UNIVERSAL PUMP CART



Mobilize your hydraulic pumps with the PC200. The rugged tubular frame can easily handle pumps weighing up to 200 lbs. With 12" wheels, the cart rolls easily. Just load the pump onto the cart and wheel it right to the job. The universal mounting hole pattern lets you handle a wide variety of Power Team pumps.

Cart can be used with the following pumps: PA60, PA64 and PA554 air/hydraulic pumps; PE55 series, PE183-2 and PE184-2 electric/hydraulic pumps; PE21, PQ60 and PQ120 series "Quiet" pumps; PG55 series gas engine/hydraulic pumps; and pumps with optional 5- and 10-gallon reservoirs; Nos. RP50, RP51, RP101 and RP103. **(Pump not included)**

Order No.	Description
PC200	Universal pump cart with 12" wheels. Wt., 27 lbs.

PROTECTIVE PUMP ROLL CAGE



Safeguards pump, gas engine and valves on the job site. Horizontal bars provide convenient hand holds for carrying pump, a pick-up point permits lifting unit with an overhead crane or other device. Standard equipment on PG1203 and PG1204. Can be ordered as an option with any other gas, air, or electrically driven hydraulic pump equipped with a 5-gallon reservoir.

NOTE: Refer to PG1203/PG1204 pump for details.

Order No.	Description
PC200RC	Roll cage for use with PC200. (Cannot be used on pumps with 10-gallon reservoirs.) Wt., 36 lbs.
RC2GAL	Roll cage for use with PA46, PA55, PE46, PE55 pumps with 2.5-gallon reservoirs.
RC5	Roll cage for PG55 & PG120. For use with PG120 and PG 55 series pumps. Wt., 19.5 lbs.

LARGE CAPACITY RESERVOIRS

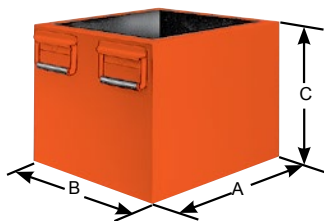

Reservoirs are equipped with drain plugs and all necessary conversion items. Hydraulic oil is not included with reservoir kits. Please order separately.

Order No.	Cap. (gal.)	Usable Oil (cu. in.)	Use With	Size (in.)		
				A	B	C
RP20**	2.0	442	PA6, PA50 series (models A-E)	11.50	9.50	6.50
RP20-F**	2.0	442	PA6 series (model F), PA 50 series (model F & G)	11.50	9.50	6.50
RP20M*	2.5	450	PA6, PA50 series (models A-E)	11.50	9.50	6.50
RP20M-F*	2.5	450	PA6 series (model F), PA50 series (model F & G)	11.50	9.50	6.50
RP21*	2.5	450	PE18 series	11.50	9.50	6.50
RP22†	2.5	442	PE55, PE120, PA55	11.50	9.50	6.50
RP50	5.0	1150	PE55, PE120, PA55	18.00	12.50	8.50
RP51	5.0	1150	PA46, PE21	18.00	12.50	8.50
RP100	10.0	2194	PE55, PE120, PA55	18.00	12.50	14.50
RP101	10.0	2194	PG55, PG120	18.00	12.50	14.50
RP103*	10.0	2310	PQ60, PQ120	15.44	12.50	12.31
RP104	10.0	2194	PA46, PE46, PE21	18.00	12.50	14.00

* Four mounting holes: 1/2"-20, for 2" diameter swivel casters (No. 10494)

† Aluminum reservoir.

** High density polyethylene reservoir.

METAL RESERVOIR CONVERSION KITS FOR PUMPS (INCLUDES GASKETS AND FASTENERS)

Pump Number	Metal Reservoir Order Number	Metal Reservoir Capacity (cu. in.)	Reservoir Wt. (lbs.)
PA6	213896	105	3.0
PA6A	213896	105	3.0
PA6D	213896	105	3.0
PA6-2	213895	578	9.0
PA6D2	213895	578	9.0

Pump Number	Metal Reservoir Order Number	Metal Reservoir Capacity (cu. in.)	Reservoir Wt. (lbs.)
PA50	213896	105	3.0
PA50R	213896	105	3.0
PA6R	213896	105	3.0
PA50R2	213895	578	9.0
PA172	213895	578	9.0

Pump Number	Metal Reservoir Order Number	Metal Reservoir Capacity (cu. in.)	Reservoir Wt. (lbs.)
PA174	213895	578	9.0
PE172	213895	578	9.0
PE172A	213895	578	9.0
PE172S	213895	578	9.0
PE174	213895	578	9.0

Model Shown:
9593

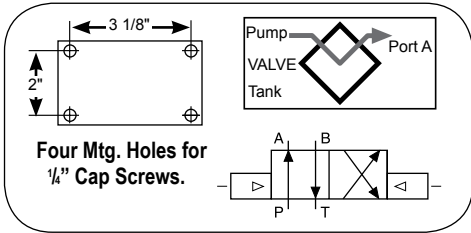
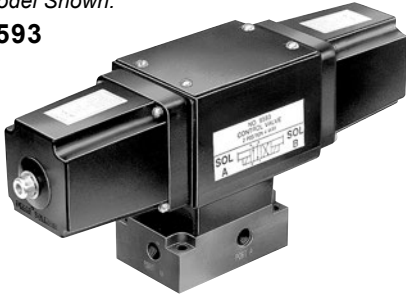

3/4-WAY / 2-POSITION SOLENOID ACTUATED VALVES

Application: Single or double-acting cylinders.

Actuation: 9593, 9524 and 9554 are solenoid-operated

Operation with single-acting cylinder: Either oil port "A" or "B" must be plugged on valve. With port "B" plugged, solenoid is energized to position "A," oil port "A" becomes pressurized. When solenoid is energized to position "B," oil port "A" becomes the return port.

Operation with multiple single-acting cylinders: A pressure line from one bank can be connected to oil port "A" and the other to oil port "B" on the valve. Sequence: When energized to position "A," oil port "A" becomes pressurized and clamps the fixture connected to oil port "A". Oil port "B" becomes a "return" port for cylinder connected to oil port "B," and retracts it. The opposite happens when solenoid "B" is energized.

Operation with double-acting cylinder: Port "A" is connected to "advance" port of cylinder, oil port "B" connects to cylinder "return" port. Solenoid is energized to position "A," oil port "A" becomes pressurized to extend cylinder piston. The opposite happens when solenoid "B" is energized. Valve does not hold in "retract" position.

NOTE: When using more than one valve on a pump, the tank port may require a check valve to permit inadvertent, momentary extension of a retracted cylinder.

NOTE: If pump is equipped with an internal outlet check, a "hold" position can be maintained with the pump shut-off.

Order No.	Description
9593	3/4-way 2-position, remote-mounted solenoid valve, 115VAC, 50/60 Hz., Prod. Wt. 15.4 lbs.
9524	3/4-way 2-position, remote-mounted solenoid valve, 230VAC, 50/60 Hz., Wt. 15.4 lbs.
9554	3/4-way 2-position, remote-mounted solenoid valve, 24VAC, 50/60 Hz., Wt. 15.4 lbs.

Accessories

Model Shown:
9595

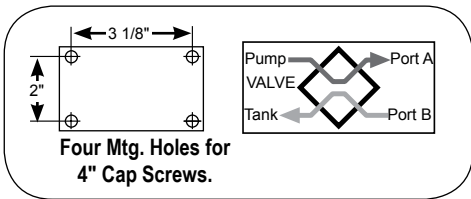

3/4-WAY / 2-POSITION AIR ACTUATED VALVES

Application: Single or double-acting cylinders.

Actuation: 9595 is air-operated.

Operation with single-acting cylinder: Either oil port "A" or "B" must be plugged on valve. With port "B" plugged, solenoid is energized to position "A," oil port "A" becomes pressurized. When solenoid is energized to position "B," oil port "A" becomes the return port.

Operation with multiple single-acting cylinders: A pressure line from one bank can be connected to oil port "A" and the other to oil port "B" on the valve. Sequence: When energized to position "A," oil port "A" becomes pressurized and clamps the fixture connected to oil port "A". Oil port "B" becomes a "return" port for cylinder connected to oil port "B," and retracts it. The opposite happens when solenoid "B" is energized.

Operation with double-acting cylinder: Port "A" is connected to "advance" port of cylinder, oil port "B" connects to cylinder "return" port. Solenoid is energized to position "A," oil port "A" becomes pressurized to extend cylinder piston. The opposite happens when solenoid "B" is energized. Valve does not hold in "retract" position.

NOTE: When using more than one valve on a pump, the tank port may require a check valve to permit inadvertent, momentary extension of a retracted cylinder.

NOTE: If pump is equipped with an internal outlet check, a "hold" position can be maintained with the pump shut-off.

Order No.	Description
9595	3/4-way 2-position, remote-mounted air-operated solenoid valve (minimum of 50 psi air pressure required), Prod. Wt. 11.4 lbs.

CAUTION: To prevent sudden, uncontrolled descent of a load as it is being lowered, use a 9596 Load-Lowering Valve or 9720 Counter Balance Valve in conjunction with the directional valve used in your application.

CAUTION: The Posi-Check® feature will not hold the load when shifted directly A to B-B to A or from hold to A or B.

NOTE: Maximum tank line pressure for remote-mounted valves is 500 psi.

Model Shown:

9508

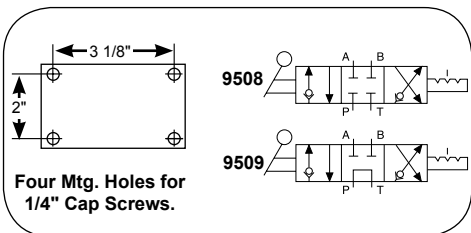
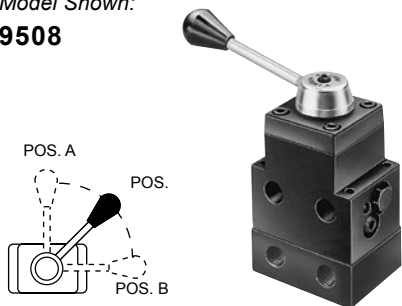

4-WAY / 3-POSITION (CLOSED CENTER) AND (TANDEM CENTER) MANUAL VALVES WITH POSI-CHECK®

Application: Single or double-acting cylinders. When used with single-acting cylinders, one port must be plugged. For double-acting cylinders, either port can be used to "advance" or "return."

Actuation: Lever-operated, detent-positioned.

Functions: The 9508 provides "advance," "hold" and "return" positions with all ports blocked (closed center) in the "hold" position. The 9509 has "advance," "hold" and "return" with tandem center (cylinder ports are blocked, pump remains running). Both valves have Posi-Check® feature to guard against pressure loss when shifting from "advance" to "hold."

Order No.	Description
9508	4-way 3-position (closed center) manual valve, including sub-plate for remote mounting. Wt., 6.3 lbs.
9509	4-way 3-position (tandem center) manual valve, including sub-plate for remote mounting. Wt., 6.3 lbs.



Model Shown:

9526

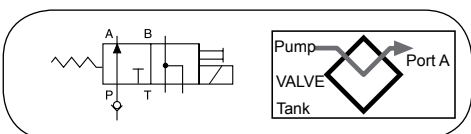

3-WAY / 2-POSITION SOLENOID VALVE

Application: Single-acting cylinders.

Actuation: Solenoid-operated, 115/230/24VAC, 50/60 Hz.

Function: Advances cylinder piston when solenoid is de-energized, and pump is running. When solenoid is energized, oil is directed back through valve "return" port and cylinder piston returns. To place cylinder in "hold" position, pump must be stopped or its flow held at the valve "pressure" port with the solenoid de-energized.

NOTE: Valve is equipped with a 9631 snubber valve in port "A." The line from the "return" port of the valve must be unrestricted (100 psi back pressure maximum) back to the reservoir.

IMPORTANT: A 9580 in-line check valve must be installed in the "pressure" port if the supply pump is not equipped with an outlet check valve.

NOTE: Valves above are shipped without control switch. Use 202777 remote hand switch.

Order No.	Description
9559	3-way 2-position solenoid valve, 115VAC 50/60 Hz. Includes a remote mounting sub-plate. Wt., 9.7 lbs.
9526	3-way 2-position solenoid valve, 230VAC 50/60 Hz. Includes a remote mounting sub-plate. Wt., 9.7 lbs.
9556	3-way 2-position solenoid valve, 24VAC 50/60 Hz. Includes a remote mounting sub-plate. Wt., 9.7 lbs.

Model Shown:

9514

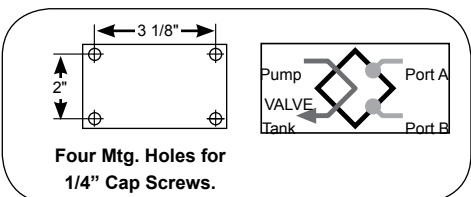

4-WAY / 3-POSITION (TANDEM CENTER) SOLENOID VALVE WITH POSI-CHECK®

Application: Double-acting cylinders.

Actuation: Solenoid-operated, 115/230/24VAC, 50/60 Hz.

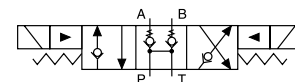

Functions: Push button control of "advance," "hold" and "return." The Posi-Check® feature guards against pressure loss when shifting from "advance" to "hold." With valve in "hold" position, cylinder ports are blocked and oil is directed from pump to reservoir.

NOTE: Do not allow return tank pressure to exceed 500 psi at the valve, Consult factory before installing a pressure switch on any of these valves.

Order No.	Description
9514	4-way 3-position (tandem center) solenoid valve, 115VAC, 50/60 Hz. Remote hand control included. Wt., 10.1 lbs.
9525	4-way 3-position (tandem center) solenoid valve, 230VAC, 50/60 Hz. Remote hand control included. Wt., 10.1 lbs.
9555	4-way 3-position (tandem center) solenoid valve, 24VAC, 50/60 Hz. Remote hand control included. Wt., 10.1 lbs.

LOAD-LOWERING VALVE

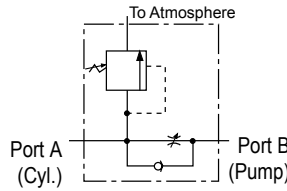

Application: Precision metering for controlled cylinder piston return.

Operation: Permits free flow when extending cylinder, built-in pressure relief and Posi-Check® locks and holds load in raised position until operator opens valve. May be pre-set to provide consistent metered return, or operator may select rate of return with each actuation. Has 3/8" NPTF ports.

NOTE: Pressure relief valve setting is 12,000 psi. Operating pressure is 10,000 psi and max. flow rate is 5 gpm.

Order No.	Description
9596	Load-lowering valve. Wt., 2.1 lbs.

SEQUENCE VALVE

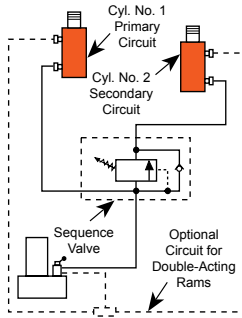
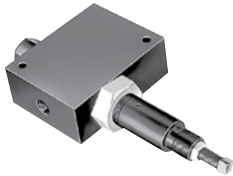

Application: Used when one cylinder in a multi-cylinder application must advance before any other.

Operation: Pump is connected to port "P" and separate cylinders to ports "A" and "B." When pressure is applied to port "P," cylinder "A" advances. Cylinder "B" will not advance until a predetermined pressure setting is reached in cylinder "A." Pressure setting is adjustable from 500 to 8,000 psi with adjustment screw (factory preset at 1,000 psi). Has 3/8" NPTF ports.

Order No.	Description
9597	Pressure control sequencing valve. Wt., 5.6 lbs.

PRESSURE REDUCING VALVE

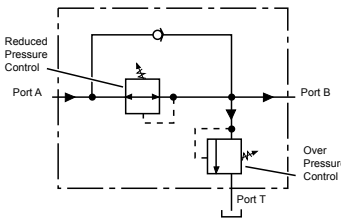

Application: Provides complete, independent pressure control to two or more clamping systems operated by a single power source.

Operation: Can be used to provide different pressures in various stages of a single system. Virtually zero leakage across valve means each system can be operated by a single continuous pressure source. Adjustable from 1,000 to 5,000 psi at outlet port "B" (secondary). Has 1/4" NPTF ports.

Order No.	Description
9608	Pressure reducing valve. Wt., 5.8 lbs.

CAUTION: Over Pressure control must be set at a higher value than operating pressure.

COUNTER BALANCE VALVE

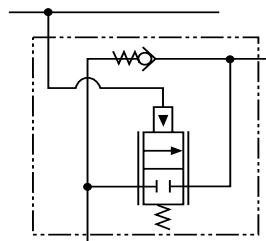

Application: Double-acting cylinders. Provides positive holding and controlled, "chatter-free" lowering of a load.

Operation: Load is raised at flow rate of pump, and held when pump is shut-off. When the pump is shifted to "retract," the counter balance valve will continue to hold the load until system pressure exceeds pressure caused by load. The load can then be lowered smoothly to the flow rate of the pump. The counter balance valve is designed to operate with pumps having a high pressure flow rate of up to 120 cu. in./min. and cylinder ratios of 3 to 1.

Order No.	Description
9720	Counter balance valve, including two pairs of fittings (male and female), hydraulic hoses, and dust caps. Wt., 10.0 lbs.
9721	Counter balance valve, including two pairs of fittings (male and female), but does not include couplers, hoses, fittings and dust caps. Wt., 9.2 lbs.

CAUTION: The 9720 patented counter balance valve has a pilot pressure as high as 3,000 psi. Because this pressure is applied to the rod end of the cylinder while it is already under load, the system should not be sized for loads greater than 80% of cylinder rated capacity. To prevent sudden, uncontrolled descent of a load as it is being lowered, use a 9596 Load-Lowering Valve or 9720 Counter Balance Valve in conjunction with the directional valve used in your application.

METERING VALVE



Application: For systems using large cylinders or extended lengths of hydraulic hose.

Operation: Controls surges by restricting flow if it exceeds 7 gpm. When flow subsides, valve reopens automatically. Has 3/8" NPTF male end to thread into return port of system control valve, and a 3/8" NPTF female end, permitting return hose to be directly connected.

Order No.	Description
9631	Metering valve. Wt., 0.2 lb.

"IN-LINE" PRESSURE REGULATOR VALVE

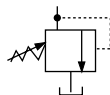

Application: Single or double-acting cylinders. Permits adjusting operating pressures at various values below relief valve setting of pump.

Operation: Regulator valve is easily adjusted to maintain pressures between 300 and 10,000 psi. Maintains a given pressure setting within 3% over repeated cycles. Flow range is 17 cu. in./minute to 6 gpm.

Order No.	Description
9633	In-line pressure regulator valve with two 3/8" NPTF inlet ports, one 1/8" NPTF tank port and 3 foot drain line kit. Wt., 1.9 lbs.

Accessories

RELIEF VALVE

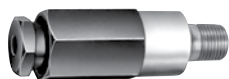

Application: Provide an economical means of protecting a hydraulic circuit against over pressurization.

Operation: These factory preset valves are designed for maximum flow rate of 5 gpm. Furnished with 1/8" NPTF male port. All valves weigh 0.2 lb. See chart below for ordering information.

NOTE: Care should be exercised to protect workers from hot, pressurized hydraulic oil. Install these valves only in an enclosed or shielded area.



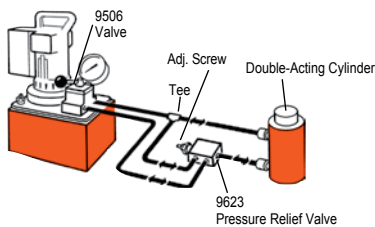
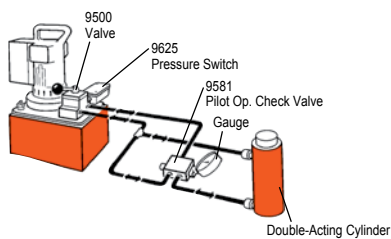

Typical Set-Up







Relief Valve Order No.	Pressure Setting* (psi)
RV21278	10,100 / 10,700
RV21278-6	600 / 640
RV21278-10	900 / 1,000
RV21278-15	1,500 / 1,700
RV21278-17	1,600 / 1,800
RV21278-20	1,900 / 2,200
RV21278-25	2,300 / 2,700
RV21278-27	2,600 / 2,800
RV21278-28	2,700 / 3,000
RV21278-30	3,000 / 3,400
RV21278-32	3,100 / 3,300
RV21278-35	3,500 / 3,800
RV21278-38	3,750 / 3,950
RV21278-40	4,100 / 4,500
RV21278-43	4,400 / 4,800
RV21278-48	4,900 / 5,300

Relief Valve Order No.	Pressure Setting* (psi)
RV21278-50	5,100 / 5,700
RV21278-52	5,300 / 5,900
RV21278-55	5,600 / 6,200
RV21278-57	5,800 / 6,400
RV21278-60	6,100 / 6,700
RV21278-65	6,600 / 7,200
RV21278-70	7,100 / 7,700
RV21278-75	7,600 / 8,200
RV21278-80	8,100 / 8,700
RV21278-83	8,400 / 9,000
RV21278-86	8,700 / 9,300
RV21278-88	8,900 / 9,600
RV21278-90	9,100 / 9,700
RV21278-114	11,500 / 12,100
RV21278-6280	6,380 / 6,900

*All RV's are Preset - Non-Serviceable

SHUT-OFF VALVE			
		<p>Application: This needle valve permits fine metering of hydraulic oil.</p> <p>Operation: Can be used for controlling multiple single-acting cylinders.</p>	
		Order No.	Description
		9575	Shut off valve with 3/8" NPTF ports. Wt., 1.4 lbs.

CHECK VALVE			
		<p>Application: Permits flow of hydraulic oil in one direction only.</p> <p>Operation: Installs right in hydraulic line.</p>	
		Order No.	Description
		9580	Check valve with 3/8" NPTF male ends. Wt., 0.4 lb.

PILOT-OPERATED CHECK VALVE			
		<p>Application: For use with open or tandem center valves. Permits free flow of fluid in one direction.</p> <p>Operation: Flow is blocked in opposite direction until pilot oil pressure is applied. This prevents the loss of pressure if the valve is inadvertently shifted or the pump line is broken. Minimum cracking pressure is 60 psi. Required pilot pressure is approximately 16% of checked system pressure.</p>	
		Order No.	Description
		9581	Pilot-operated check valve with 3/8" NPTF ports. Wt., 3.8 lbs.

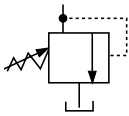
"IN-LINE" PRESSURE RELIEF VALVE			
		<p>Application: Single or double-acting cylinders. For remote locations in a hydraulic circuit where maximum pressure requirements are less than basic overload valve setting in pump.</p> <p>Operation: Adjustable from 1,000 to 10,000 psi. Valve is spring-loaded and direct-acting.</p>	
		Order No.	Description
		9623	Pressure relief valve with 3/8"NPTF ports. Wt., 2.0 lbs.

Model Shown:
9639, 9638



Performance Requirements

For additional technical information or to order a **Material Safety Data Sheet** call 1-800-477-8326 or go to www.powerteam.com.

Features

STANDARD HYDRAULIC OIL

- For dependable performance of all your hydraulic pumps and cylinders.
- Contains foam suppressant additives and has a high viscosity index.

FLAME-OUT® 220 FIRE RESISTANT HYDRAULIC FLUID*

- Contains anti-rust, anti-foam and anti-sludge additives.
- Provides fire resistant protection. Note: Will burn if heat source is extreme enough. Will not, however, propagate the flame and is self-extinguishing when there is no ignition source.

- Provides maximum lubrication and heat transfer.
- Offers a wider operating temperature range.

- No need to change seals in your Power Team equipment. Just drain the standard oil and replace it with Flame-Out® 220.

BIODEGRADABLE HYDRAULIC FLUID

- Biodegradable, non-toxic fluid withstands moderate to severe operating conditions. Provides excellent protection against rust.
- Offers superior anti-wear properties and has excellent multi-metal compatibility.

LOW TEMPERATURE OIL

- Provides smooth, reliable operation in the coldest climate conditions.

Accessories

Technical Specifications

Description	Grade (ASTM)	Specific Gravity @ 60°F	Color (ASTM)	Flash Point (in.)	Fire Point (in.)	Pour Point (in.)	Viscosity		Viscosity Index	Foam Test (ASTM)
							SUS @ 100°F (psi.)	SUS @ 210°F (psi.)		
Standard Oil	215	0.88	2 Amber	400°F	430°F	-30°F	215	48	100 min.	Pass
Flame-Out®	220	0.91	Light Amber	500°F	550°F	-15°F	220	55	140 min.	Pass
Biodegradable	—	0.92	2 Amber	320°F	Not available	-11°F	183	53	213 min.	Pass
Low Temp.	—	0.87	6.5 Red	356°F	399°F	-48°F	183	52	190 min.	Pass

Ordering Information

Order Number	Oil Description	Quantity
9636	Standard Oil	1 quart
9637		1 gallon
9638		2.5 gallons
9616		55 gallons
9639	Flame-Out®	1 gallon
9640		2.5 gallons
9645	Biodegradable	1 gallon
9646		2.5 gallons
9647	Low Temperature	1 gallon

ON/OFF MOTOR CONTROL



25017



203225



10461



251660

The following remote control switches will give you momentary "ON" control of your hydraulic pump. These switches are deadman type, spring loaded to the "OFF" position. They can be used with any Power Team electric hydraulic pump.

Order No.	Description
25017	Remote hand control. Has a push button switch, with a 10 foot cord. Wt., 0.8 lb.
203225	Remote hand control. Heavy-duty with single push button switch in a neoprene housing with 10 foot cord. Housing seals out dust, lint and liquids (unit is not submersible). Wt., 0.8 lb.
10461	Remote foot control, with 10 foot cord. Wt., 3.0 lbs.
251660	Remote foot control, with 10 foot cord. For use with the PE10 style pumps. Wt., 1.0 lb.

SOLENOID & MOTOR CONTROL



**202777
202778
304718**



**309652
309653**



209593



**17627
216209**

Order No.	Description
202777 *	Remote hand control. Has rocker style switch that is momentary advance, spring center hold and detented retract. It comes with a 10 foot cord, for use with 3-way/2 or 3-position valves. Wt., 0.9 lb.
202778 **	Remote hand control. Has rocker style switch that is momentary advance, spring center hold and momentary retract. It comes with a 10 foot cord, for use with 4-way/3-position valves. Wt., 0.9 lb.
304718**	Remote hand control. Has a rocker style switch that is momentary advance, spring center hold and momentary retract. The switch is wired to start and stop the motor when the valve is energized. It comes with a 10 foot cord. To be used with 4-way/2-position valves. Wt., 0.9 lb.
309653	Remote foot control. Can be used in place of either of the above hand controls to control the same type of valves. The switch is momentary on, both advance and retract position, and is spring centered to the hold position. This foot switch comes with 10 foot cord. Wt., 4.0 lbs.
17627	Remote foot control. Same as the 309653, but without a cord. Wt., 2.0 lbs.
309652	Remote foot control. Has same functions as 304718. Supplied with a 10 foot cord. To be used with 4-way/2-position valves. Wt., 4.0 lbs.
216209	Remote foot control. Same as the 309652, but without a cord. Wt., 2.0 lbs.

* For use on solenoid valves that are used on single-acting cylinders
 ** For use on solenoid valves that are used on double-acting cylinders

NOTE: See valves listing to determine which remote to use.

REMOTE AIR MOTOR CONTROLS



209593

This remote hand control has two momentary push buttons, one for advance and one for retract with spring offset to hold. To be used with 4-way/2-position air pilot valves.

Order No.	Description
209593	Remote hand control with 12 foot cord. Wt., 2 lbs.

SUB-PLATES



9510



9620

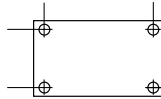

9510 and 9620 attach to the bottom of valve for remote mounting.

For remote mounting of control valves. Sub-plates convert pump-mounted valves to remote-mounted valves quickly and easily.

Order No.	Description
9510	Sub-plate for remote mounting the following valves; 9500, 9501, 9502, 9504, 9506, 9507, 9511, 9552, 9572, 9575, 9576, 9592 and 9594. Wt., 1.5 lbs.
9620	For use with 9500, 9501, 9502, 9552, 9572, 9592 and 9594. Same as 9510, but has integral pressure regulating valve. Wt., 3.8 lbs.

PUMP-MOUNTED SUB-PLATES



9515

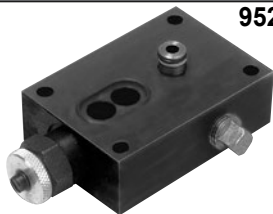

9521

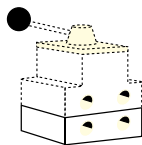

The 9515 and 9521 mount between the pump cover plate and valve.

When fitted between pump cover plate, valve mounting flange, and control valve, provides a separate 3/8" NPTF female port, open to "return" regardless of position of valve. Also provides a separate 3/8" NPTF female pressure port. This sub-plate can be useful when you desire to use one pump with a deck-mounted control valve, plus a separate remote-mounted valve to control another function.

For use with the following valves: 9500, 9501, 9502, 9504, 9506, 9507, 9511, 9520, 9552, 9572, 9575, 9576, 9592, 9594, and 9609.

Order No.	Description
9515	Sub-plate, Wt., 1.3 lbs.
9521	Sub-plate for use under most pump-mounted valves to provide adjustable pressure control on units not equipped with an external pressure regulator. Wt., 3.8 lbs.

AIR FILTER/REGULATOR/LUBRICATOR

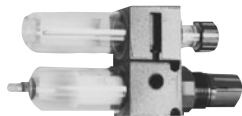

Recommended for use with single-speed air/hydraulic pumps.

Order No.	Description
9531	Filter/regulator. 1/4" NPTF inlet and outlet. Wt., 0.8 lb.

PRESSURE SWITCH

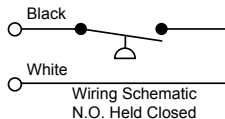

Application: Used in a hydraulic circuit where system pressure must be "held." Automatically (electrically) turns off pump motor when predetermined system pressure is reached.

Attaches directly to control valve manifold or can be mounted in-line to read system pressure. Has a 1/4" NPTF male thread, and a 1/4" NPTF fitting for gauge mounting if required. Adjustable from 1,000 to 10,000 psi. Can also be used to actuate other electrical devices in the system. Wired normally open and held closed by spring pressure.

Order No.	Description
9625	In-line pressure switch with 1/4" NPTF gauge port. Wt., 1.1 lbs.

IMPORTANT: Electrical rating of switch is 5 amps at 250VAC max. To prevent permanent damage to switch, a control relay must be installed to handle currents or voltage exceeding these limits. Pressure switch should never be used to directly actuate the electrical motor.

PILOT-OPERATED AIR CONTROL VALVES



Application: For use when an air pilot signal is required at a set hydraulic pressure. Can be used to shift valves, and start or stop pneumatic pumps.

Attaches directly to control manifold or can be mounted in-line to read system hydraulic pressure. Automatically turns on an air pilot signal when a predetermined system pressure is reached. Has 1/4" NPTF male thread and 1/4" NPTF fitting for gauge mounting if required. Adjustable from 500-10,000 psi. Maximum rating of 25 scfm at 100 psi.

Order No.	Description
9641	Pilot-operated control valve, normally closed, with 1/4" NPTF male thread. Wt., 1.0 lb.
9643	Pilot-operated control valve, normally open, with 1/4" NPTF male thread. Wt., 1.0 lb.

Model Shown:

9755



Accessories

Features

REINFORCED WIRE-BRAID RUBBER HOSES OFFER INCREASED DURABILITY

- 2-ply rated hose reinforced with two braids of high tensile steel wire.
- The rubber covering is oil and weather resistant.
- Hoses are equipped with spring guards.
- 3/8" NPTF fittings on both ends.
- Operating pressure is 10,000 psi. All comply with MHI standard IJ100.
- These hoses are MSHA approved.



Cylinder Return Time

Cylinder No.	9769	9781
	10 Ft. Hose 1/4" I.D.	10 Ft. Hose 3/8" I.D.
C2514C	51 sec.	14 sec.
C556C	1 min., 30 sec.	24 sec.
C5513C	4 min., 12 sec.	59 sec.
C10010C	6 min., 56 sec.	1 min. 3 sec.



Hose with Coupler Half



9754 hose coupler with 9798 hose half coupler and 9800 dust cap.

Ordering Information

Hose Type	Hose I.D.	Hose Length (ft.)	Burst Rating (psi.)	Order Number
Rubber, Wire-Braid	1/4"	3	20,000	9755
Rubber, Wire-Braid	1/4"	6	20,000	9756
Rubber, Wire-Braid	1/4"	6	20,000	9754**
Rubber, Wire-Braid	1/4"	8	20,000	9757
Rubber, Wire-Braid	1/4"	10	20,000	9758
Rubber, Wire-Braid	1/4"	12	20,000	9759
Rubber, Wire-Braid	1/4"	20	20,000	9760
Rubber, Wire-Braid	1/4"	30	20,000	9761
Rubber, Wire-Braid	1/4"	50	20,000	9762

Hose Type	Hose I.D.	Hose Length (ft.)	Burst Rating (psi.)	Order Number
Rubber, Wire-Braid*	3/8"	3	20,000	9733
Rubber, Wire-Braid*	3/8"	6	20,000	9776
Rubber, Wire-Braid*	3/8"	10	20,000	9777
Rubber, Wire-Braid*	3/8"	15	20,000	9734
Rubber, Wire-Braid*	3/8"	20	20,000	9778
Rubber, Wire-Braid*	3/8"	30	20,000	9735
Rubber, Wire-Braid*	3/8"	40	20,000	9736
Rubber, Wire-Braid*	3/8"	50	20,000	9779

* High Flow

**Furnished with 9798 hose half coupler and 9800 dust cap.

Model Shown:
9767



>Features

POLYURETHANE HOSES OFFER HIGHER BURST PRESSURE RATINGS OVER BRAIDED RUBBER.

- Nylon core tube with polyester fiber reinforcement.
- Hoses are equipped with plastic hose guards (except for the 1/4" I.D. polyurethane hoses which have spring guards).
- Withstands the minimum SAE bend radius without shortening service life.
- These hoses last up to seven times longer than rubber hose.
- Suitable for continuous service at temperatures from -40° to 150° F.



BE SAFE!

1. Inspect before and after each use.
2. Replace if any signs of degradation or wear that may affect safety or performance.
3. Keep the product clean.
4. Store properly.



Cylinder Return Time

Cylinder No.	9769	9781
	10 Ft. Hose 1/4" I.D.	10 Ft. Hose 3/8" I.D.
C2514C	51 sec.	14 sec.
C556C	1 min., 30 sec.	24 sec.
C5513C	4 min., 12 sec.	59 sec.
C10010C	6 min., 56 sec.	1 min. 3 sec.

> Ordering Information

Hose Type	Hose I.D.	Hose Length (ft.)	Burst Rating (psi.)	Order Number
Polyurethane	1/4"	2	20,000	9765
Polyurethane	1/4"	3	20,000	9766
Polyurethane	1/4"	6	20,000	9767
Polyurethane	1/4"	6	20,000	9764**
Polyurethane	1/4"	8	20,000	9768
Polyurethane	1/4"	10	20,000	9769
Polyurethane	1/4"	12	20,000	9770
Polyurethane	1/4"	20	20,000	9771
Polyurethane	1/4"	50	20,000	9772
Polyurethane	1/4"	75	20,000	9750
Polyurethane	1/4"	100	20,000	9751

Hose Type	Hose I.D.	Hose Length (ft.)	Burst Rating (psi.)	Order Number
Polyurethane*	3/8"	6	30,000	9780
Polyurethane*	3/8"	6	30,000	9780
Polyurethane*	3/8"	10	30,000	9781
Polyurethane*	3/8"	20	30,000	9782
Polyurethane*	3/8"	50	30,000	9783

* High Flow

**Furnished with 9798 hose half coupler and 9800 dust cap.

Model Shown:

9774



Accessories

Features

NON-CONDUCTIVE HOSE

- For applications requiring electrical isolation.
- 3/8" NPTF fittings on both ends
- Leakage factor of less than 50 micro-ampere.
- Orange polyurethane for easy identification.
- Covering is not perforated, preventing moisture from entering the hose and affecting its overall conductivity.
- Hoses feature a minimum 40,000 psi burst pressure.



BE SAFE!

- Inspect before and after each use.
- Replace if any signs of degradation or wear that may affect safety or performance.
- Keep the product clean.
- Store properly.



Torque Wrench Hoses - Non-Conductive Dual Line



Order Number	Hose Length (ft.)	Hose I.D. (in.)
TWH15	15	1/4"
TWH20	20	1/4"
TWH30	50	1/4"

For torque wrench tools, refer to the tool section.

Ordering Information









Order Number	Couplers / Fitting	Hose I.D. (in.)	Hose Length (ft.)	Burst Rating (psi.)
9773	3/8" Fitting NPTF	1/4"	6	40,000
9774	3/8" Fitting NPTF	1/4"	10	40,000
9775	3/8" Fitting NPTF	1/4"	20	40,000
2000351	3/8" Fitting NPTF	1/4"	15	40,000
2000350	3/8" Fitting NPTF	1/4"	25	40,000
3-3944*	Male / Male Couplers †	1/4"	6	40,000
3-3945*	Male / Male Couplers †	1/4"	10	40,000
3-3946*	Male / Male Couplers †	1/4"	15	40,000
3-3947*	Male / Male Couplers †	1/4"	25	40,000
3-3956*	Male / Female Couplers †	1/4"	6	40,000
3-3957*	Male / Female Couplers †	1/4"	10	40,000
3-3958*	Male / Female Couplers †	1/4"	15	40,000
3-3959*	Male / Female Couplers †	1/4"	25	40,000







* Hoses are prefilled with hydraulic fluid.

† Dust caps are included with coupler.

CYLINDER AND HOSE COUPLERS are designed for use up to 10,000 psi with hydraulic jacks, cylinders, etc. They are the threaded union type for interchanging cylinders in seconds. Each half is valved with a precision ball for a tight shutoff when disconnected. These couplers also permit the separation of cylinders or hose from pump when at 0 psi with minimal oil loss.

NO SPILL, PUSH TO CONNECT COUPLERS are designed to permit high oil flow, the no-spill, push-to-connect couplers with locking collar and flush face design are for high pressure applications. The flush-face concept makes it easy to clean both coupler ends before connecting. Our unique push-to-connect, "dry-break" design eliminates oil spillage. The locking collar makes accidental disconnects a thing of the past. For 10,000 psi operation.

	Order No.	Description
	9795	Complete quick coupler with two 9800 dust caps, 3/8" NPTF.
	9798	Mail (hose) half coupler 3/8" NPTF.
	9796	Female (cylinder) half coupler with 9800 dust cap, 3/8" NPTF.
	9796-V*	Female (cylinder) half coupler with Viton™ seals and 9797 metal dust cap, 3/8" NPTF.
	9796-E	Female (cylinder) half coupler with EPR seals and No. 9797 metal dust cap, 3/8" NPTF.
	9799	Optional metal dust cap (hose half).
	9797	Optional metal dust cap for cylinder half.
	9800	Dust cap for male or female 3/8" NPTF half couplers. (Wt., 0.3 lb.)

	Order No.	Description
	251410	Quick-connect, screw-on female coupling. Used on 700 bar torque wrenches, nut-splitters, hoses, and pumps. 1/4" NPT Female Thread
	251411	Quick-connect, screw-on male nipple. Used on 700 bar torque wrenches, nut-splitters, hoses, and pumps. 1/4" NPT Female Thread
	252364	Metal dust cover for female coupler
	252365	Metal dust cover for male coupler
	9792	No-spill, push-to-connect, Female (cylinder) half quick coupler only. (Wt., 0.3 lb.)
	9793	No-spill, push-to-connect, Male (hose) half quick coupler only. (Wt., 0.3 lb.)
	9794	No-spill, push-to-connect, Complete quick coupler (male and female). Dust caps not included. (Wt., 0.5 lb.)

* Viton™ is an trademarks or registered trademarks of The Chemours Company

Model Shown:

9040, 9052, 9089



Accessories



Accessories for Analog Gauges



9046 - Silicone Fill Kit

Silicone fill kit. 7.5 fl. oz. Requires one bottle to fill 4" gauge; four bottles to fill 6" gauge.



9049 - Dampener Fitting

High-performance pulsation dampener. 1/4" NPTF male x 1/4" NPTF female.

Features

HEAVY-DUTY HYDRAULIC PRESSURE GAUGES

- Gauges feature an easily readable and highly visible, red Day-glo® needle.
- High strength steel bourdon tube ensures high cycle life.
- Stainless steel cases and lens locking rings.
- Have 1/4" NPT connections.
- Gauges are calibrated and comply to ASME B40.1 GRADE B



Typical Set-Up - Mounting Situations

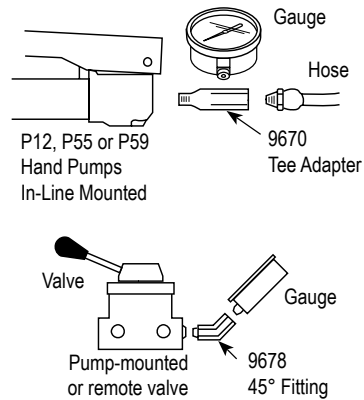

Ordering Information

Order Number	Face Dia. (in.)	Pressure Range (psi.)	Tonnage Range (ton)	Major Graduations (psi.)	Minor Graduations (psi.)	Silicone Filled (Yes/No)	Use With Cylinder Series (ft.)
9040	2.5	0-10,000	-	2500 psi	500 psi	Yes	All
9041	2.5	0-10,000	-	2500 psi	500 psi	No	All
9051	4.0	0-10,000	-	1000 psi	200 psi	No*	All
9052	4.0	0-10,000	-	1000 psi	200 psi	Yes	All
9059	4.0	0-10,000	0-17.5, 0-30, 0-50	2000 psi, 5 Ton	200 psi, .5 Ton on 30, 50 Ton Scales; .2 Ton on 17.5 Ton Scale	No*	RT172, RT302, RT503
9053	4.0	0-10,000	0-5	2000 psi, 1 Ton	200 psi, .1 Ton	No	C & RLS
9055	4.0	0-10,000	0-10	2000 psi, 1 Ton	200 psi, .1 Ton	No*	C, RD, RH, RLS & RSS
9063	4.0	0-10,000	0-25	2000 psi, 5 Ton	200 psi, .5 Ton	No*	C & RD
9065	4.0	0-10,000	0-30	2000 psi, 5 Ton	200 psi, .5 Ton	No*	RH†, RLS & RSS
9067	4.0	0-10,000	0-50	2000 psi, 5 Ton	200 psi, .5 Ton	No*	RH†, RLS & RSS
9069	4.0	0-10,000	0-55	2000 psi, 5 Ton	200 psi, .5 Ton	No*	C, R, RA & RD
9071	4.0	0-10,000	0-60	2000 psi, 5 Ton	200 psi, 1 Ton	No*	RH, except RH6010
9075	4.0	0-10,000	0-100	2000 psi, 10 Ton	200 psi, 1 Ton	No*	C, R, RA, RD, RH, RLS†, RSS† & RT1004†
9077	4.0	0-10,000	0-150	2000 psi, Initial 10 Then 20 Ton	200 psi, 2 Ton	No*	C, R, RD & RLS
9079	4.0	0-10,000	0-200	2000 psi, 20 Ton 10 Then 20 Ton	200 psi, 2 Ton	No*	R, RD & RH†
9089	6.0	0-10,000	0-690	1000 psi	100 psi	No*	All

* Shipped "dry." User can convert to "wet" using liquid silicone No. 9046.

† The tonnage scale on the gauge may vary slightly among different series cylinders due to different effective area.

Model Shown:

DG100



Features

DG100 DIGITAL PRESSURE GAUGES

- Accurate to within 1%, Long-life pressure transducer.
- Pressure values are displayed on large red LEDs in 10 psi or bar increments.
- “Peak” hold feature with reset toggle switch and “Peak On” indicator; Hi/Low set point feature with relay outputs for Hi/Low alarms and/or control signals.
- A slow flashing display indicates pressure below the low limit. Fast blinking display alerts if limit is exceeded.
- High and low limit relays are rated to 5 amps at 115VAC.
- Operating temperature of 0 to 140°F for the electronic display and -20 to 180°F for the transducer.
- Gauge housings are extruded aluminum 1/8" DIN enclosures (NEMA 1 rating).
- When power cable is connected to gauge, display will scroll all characters, performing a self- diagnostic routine.
- 1/4" NPTF male threads for the pressure connection.
- 6-foot input signal cable connects to back of display unit.

Accessories



Accessories for DG100



420778 - Digital Gauge Stand

Gauge stand for DG100. Has angled base mounting to hold gauge at a convenient viewing angle. Wt., 1.2 lbs.



37045 - Auxiliary Power Cord

Auxiliary power cord for use with any 12 or 24VDC battery. Wt., 0.2 lb. *Caution: For use on negative ground systems only.*

Ordering Information

Order Number	Description	Pressure Range	Prod. Wt. (lbs.)
DG100 *	Digital pressure gauge	0 - 10,000 (psi.)	2.3
DG100B *	Digital pressure gauge	0 - 700 (bar)	2.3

* Serviced only at factory.

Model Shown:

9042DG, 9042DG1500

Accessories



Features

- Digital gauge is easier to read and offers better accuracy than a conventional analog gauge.
- The laser welded stainless steel sensor & socket and the IP67 weatherproof rating make this product suitable for use in the most demanding of applications.
- Five pre-programmed engineering units allow technicians to read pressure in the unit of measure most applicable to the process.
- The gauge also features a bar graph display feature for enhanced visibility.
- Includes automatic-off battery conservation, pressure tare, minimum pressure memory and maximum pressure.
- Vibration & shock tested to MIL-STD-202G.
- Agency Compliance / Approval: RoHS, CE, ASME B40.7, UL, cUL 61010-1.
- The gauges are calibrated for life at the factory and can be certified in the field, if required.



Other Digital Gauges - DG100



- **DG100** (psi) digital gauge.
- **DG100B** (bar) digital gauge.

Upgrade to **DG100** or **DG100B** when:

- Hi/Low alarms required.
- Relays triggered by Hi/Low pressure.
- Pressure display needs to be remotely mounted from measurement location.
- Accurate within 1% @ Full Scale.

▶ Power Team's 9042DG was the perfect choice in accurately monitoring the force applied in this H frame press application.



Technical Attributes



- 1 Protective rubber boot
- 2 Back-light and large 0.48" (12.2 mm) display easy reading
- 3 Displays in multiple engineering units: psi, bar, mPa, inHg, kg/cm²
- 4 Weatherproof IP67 enclosure
- 5 2,000 hr. life, (2) AA (LR6) batteries
- 6 Typical Cycle Life: 10,000,000
- 7 1/4" NPTF Male Threads (9042DG); 9/16-18 UNF-2B (9042DG1500)

Technical Specifications

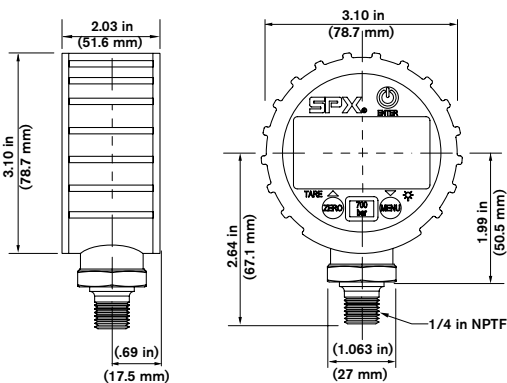

Ordering Information

Order No.	Face Dia. (in.)	Rated Pressure (psi.)	Temp Range (°F)	Tool Use	IP Rating	Batteries Included	Battery Life (hrs.)	F.S. Accuracy	Prod. Weight (lb.)
9042DG	2.5	0-10,000	-4 to +140	All	IP67	2 x AA (LR6)	2,000	0.50%	0.53
9042DG1500	2.5	0-21,750	-4 to +140	All	IP67	2 x AA (LR6)	2,000	0.25%	0.53



Typical Mounting Setups for 9042DG

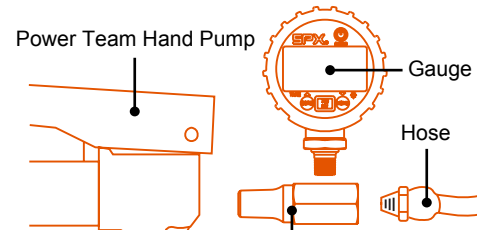

Tee adapter (No. 9670) is used for installing a gauge in line in a hydraulic circuit.

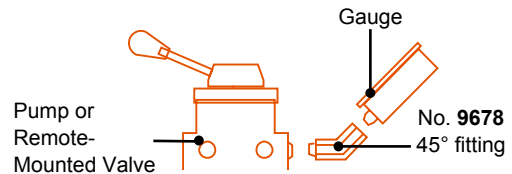

Accessories



Hardware Requirements for 9042DG



- Does your pump have a 3/8" or 1/4" NPTF port?
- Are you direct-plumbing the gauge to your tool or seeking to quick-disconnect?
- Refer to the Power Team Catalog under the accessories section for a comprehensive range of fittings and couplers to meet your needs.











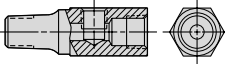

Custom Scale

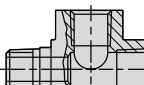
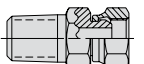
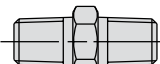
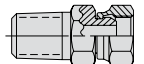



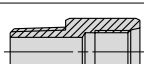

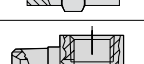

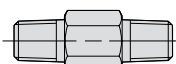

User programmable unit of measure allows you to set a custom scale to have the gauge display torque, force or weight to match the cylinder or tool being used.

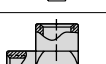

Safety Tip

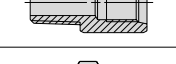
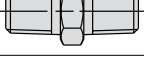
When using couplers to detach the gauge, always use a metal cover (ordered separately) on the pump side (female) coupler when the gauge is removed.

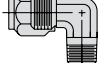
	Order No.	Description
	9190	Hydraulic tubing. 3/8" O.D. x .065" wall, 50 ft. (10 pieces 5 feet long.) Wt. 12.0 lbs.
	9670	Tee adapter. For installing gauge between pump and hose coupling. Has 1/4" and 3/8" NPTF female and 3/8" NPTF male ports. Wt. 0.5 lb.
	9671	Double tee adapter. Permits use of more than one cylinder in series with one pump. Three 3/8" NPTF female ports. Wt. 1.0 lb.
	9672	Service tee. Two 3/8" NPTF female internal, one 3/8" NPTF male external. Wt. 0.6 lb.
	9673*	Swivel connector. 3/8" NPSM male, 1/4" NPSM female. Wt. 0.2 lb.
	9674	Male connector. 1-11/16" long, 1/4" x 3/8" NPTF. Wt. 0.2 lb.
	9675*	Swivel connector. 3/8" NPTF male, 3/8" NPSM female. Wt. 0.2 lb.
	9676*	Swivel connector. 1/4" NPTF male, 3/8" NPSM female. Wt. 0.2 lb.
	9677*	45° swivel connector. 3/8" NPTF male, 3/8" NPSM female. Wt. 0.3 lb.
	9678	45° fitting. Used when mounting gauge at an angle on connection such as 9670. Male and female 1/4" NPTF ends. Wt. 0.3 lb.
	9679	Connector. 1/4" NPTF female and 3/8" NPTF male. Wt. 0.1 lb.
	9680	Coupling. Both ends 3/8" NPTF female. Wt. 0.2 lb.
	9681	Street elbow. Male and female 3/8" NPTF ends. Wt. 0.3 lb.
	9682	Male connector. 1-11/16" long, 3/8" NPTF male ends. Wt. 0.1 lb.
	9683	Male connector. 2-1/4" long, 3/8" NPTF male ends. Wt. 0.2 lb.

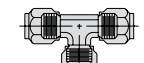
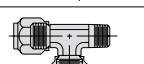
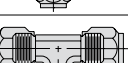
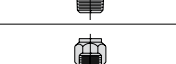
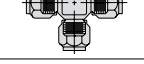





	Order No.	Description
	9684	Male connector. 2-1/4" long, 1/4" NPTF male ends. Wt. 0.2 lb.
	9685	Coupling. 1/4" NPTF female and 3/8" NPTF female. Wt. 0.2 lb.
	9686	90° elbow. 3/8" NPTF female ends. Wt. 0.4 lb.
	9687	Pipe plug. Heat-treated, 3/8" NPTF. Wt. 0.1 lb.
	9688	Pipe plug. Heat-treated, 1/4" NPTF. Wt. 0.1 lb.
	9689	Connector. 1/4" NPTF male and 3/8" NPTF female. Wt. 0.2 lb.
	9690	Male connector. 1-11/16" long, 1/4" NPTF male ends. Wt. 0.1 lb.
	9692	Straight connector. 3/8" tube x 3/8" male NPTF. Wt. 0.2 lb.
	9693	90° elbow. 3/8" tube x 3/8" male NPTF. Wt. 0.2 lb.
	9694	45° elbow. 3/8" tube x 1/4" male NPTF. Wt. 0.2 lb.
	9695	Tee. 3/8" tube. Wt. 0.3 lb.
	9696	Male run tee. 3/8" tube x 1/4" male NPTF. Wt. 0.3 lb.
	9697	Male branch tee. 3/8" tube x 1/4" male NPTF. Wt. 0.3 lb.
	9698	Cross. 3/8" tube. Wt. 0.4 lb.
	9699	45° gauge fitting. 3/8" NPTF male and female, and 1/4" NPTF female at 45°. Wt. 0.6 lb.
	9705	Fitting, swivel. 3/8" NPTF male to 3/8" NPTF female. 90° fitting with internal 370 micron screen. May be rotated 360° about male thread axis.

* **CAUTION:** On part numbers 9673, 9675, 9676 and 9677 the female swivel end of these adapters is a straight pipe thread (NPSM) with a 30° seat. All male pipe fittings that are used with these female swivel adapters must have an internal 30° seat in order to effect a proper seal. All Power Team male fittings are manufactured with a 30° seat except 9687 and 9688.

NOTE: Power Team hydraulic fittings are intended for use with our high pressure hydraulic products and are suitable for use at max. working pressures of 10,000 psi unless otherwise noted.

MANIFOLD BLOCKS

Select from a wide assortment of high pressure manifold blocks to customize your system.



	Order No.	Description
	9691	"Y" Manifold. Extremely useful when connecting two hydraulic cylinders to a single line. Has three 3/8" NPTF ports. Wt. 1.0 lb.
	9634	Manifold block. This manifold is for multiple-cylinder installations, has four 3/8" NPTF ports and two 1/4" mounting holes. 2" Square 1.5" thick. Wt. 1.5 lbs.
	9635	Manifold block. This hex-shaped manifold offers extra versatility with six 3/8" NPTF ports and two 1/4" mounting holes. 2.5" Hex x 1.25" thick. Wt. 2.0 lbs.
	9617	Manifold block. When a multiple-cylinder installation is required, this manifold is invaluable. Has six 3/8" NPTF ports to handle larger multiple-cylinder systems. Wt. 3.0 lbs.
	9648	Manifold block. This 7" long manifold block has seven 3/8" NPTF ports and two 1/4" mounting holes. Wt. 2.7 lbs.
	9627	Manifold block. This 16" long manifold block allows you to mount the 9575 or 9596 valves without interference. Has seven 3/8" NPTF ports and two 1/4" mounting holes. Wt. 6.0 lbs.
	9626	Pump-mounted, manifold block. Converts pump-mounted valves for use with remote-mounted valves. This manifold block is sub-plate mounted on the pump cover plate and provides 3/8" NPTF pressure and return ports. Maximum recommended flow rate is 5 gpm. Note: If used on PE30 or PG30 series pump, 1/2" longer mounting screws are required. Order four (4) No. 11956 screws separately.

Technical Dimensions

Manifold Number	A (in.)	B (in.)	C (in.)
9627	16.00	4.50	1.50
9648	7.00	1.50	1.50

MANIFOLD BLOCKS WITH NEEDLE VALVES

For independent multiple-cylinder operation, feature needle valves for precise manual control.

	Order No.	Description
	9642	2-Port Manifold. Manifold with two needle valves for control of two cylinders. Has four 3/8" NPTF ports. Wt. 8.2 lbs.
	9644	2-Port Manifold. Manifold with four needle valves for control of four cylinders. Has six 3/8" NPTF ports. Wt. 16.2 lbs.

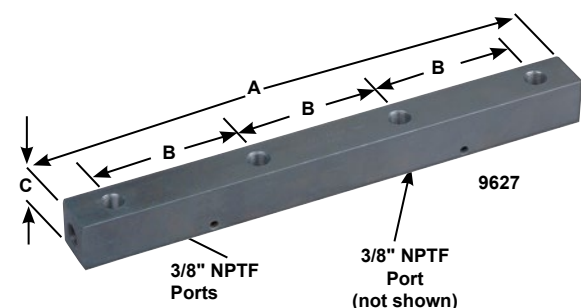
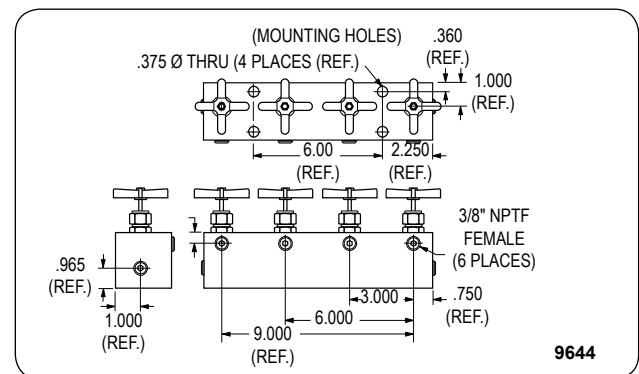
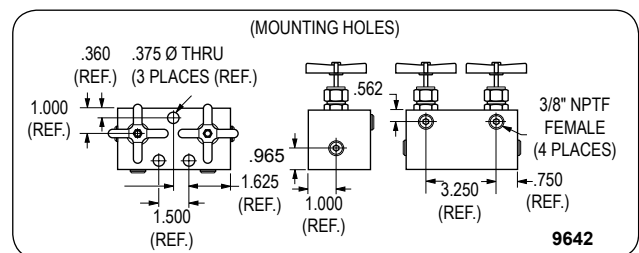

SHOP PRESSES



THE PREFERRED CHOICE FOR HEAVY-DUTY, RIGID SHOP EQUIPMENT

Every piece of shop equipment goes through a detailed fabrication and assembly process, and is thoroughly inspected to ensure maximum performance in the field.

- Wide selection of H-Frame, C-Frame, and load positioning equipment to fit a wide range of applications.
- Turnkey models from available with a variety of power units ranging in manual, electric, air, and gas-driven variations.
- Array of reservoir sizes from 0.25 to 55 gallons
- Valve configurations, such as dump, 2-way, 3-way and 4-way in manual and solenoid options,
- Hydraulic flow up to 420 cu. in. @ 10,000 PSI.





	Section / Series	Shop Equipment	Cylinder Type	Tonnage Range	Pages
	Introduction	—	—	—	147-148
	SPM, SPX	C-Frame	Single-Acting, Spring Return	25	149
	SPM, SPH, SPE	H-Frame	Single-Acting Double-Acting	10	150
	SPA, SPM, SPE	H-Frame Economy	Single-Acting	25	151
	SPA, SPM, SPE	H-Frame Open-End-Access™	Single-Acting Double-Acting	25	152
	SPA, SPM, SPE	H-Frame	Single-Acting Double-Acting	55	153
	SPM, SPE	H-Frame	Single-Acting Double-Acting	100	154
	SPE	H-Frame	Double-Acting	150-200	155-156
	RB	H-Frame Roll-Bed®	Double-Acting	80-200	157-158
	A	Accessories	—	—	159-160
	FC	Floor Cranes	—	—	161
	LR	Load Rotors®	—	2,000 - 6,000 LBS.	162



SELECTING THE RIGHT SHOP EQUIPMENT:

Step 1 What is the largest size of material you will be working with on your application?

Step 2 What capacity, or pressure, is required to perform the work?

Step 3 What is the speed, or frequency, the press will be operated. (ad-hock or production use)?

SHOP EQUIPMENT SIZING CONSIDERATIONS:

Knowing how a hydraulic press operates can help you determine whether or not you need one for your application. If a press is needed, ask yourself these four questions.

1. What is the size of the largest work piece? For arbor and H-Frame presses, this will dictate the throat size (horizontal opening) and daylight (vertical space required).
2. What pressure is required OR what capacity is required? For arbor presses and H-Frame presses this will dictate how much force is required to perform the pressing operation. It is recommended
3. What speed and/or frequency do I need to operate the press?
4. How many parts or operations per shift is required? If the required amounts are quite high, an electric or air model power pump would be more suited verses a manual hand pump.

When selecting Power Team's Shop Equipment, you will need to select the type of press style, cylinder size and prime mover to operate and control the press.

Basic components for our shop equipment:

- A pump (or prime mover) is used to transfer the oil from a reservoir out to the tool. This can be in the form of an electric, air or manual pump.
- A control valve is used to divert or meter the flow / direction / volume of the oil out to the tool.
- A cylinder or work-head is used to fill the area above the piston cap with oil through the A-port. This forces the piston down.
- The control valve then redirects the oil either to the B-port for double-acting cylinders or diverts it back to the reservoir on spring return single-acting cylinders.



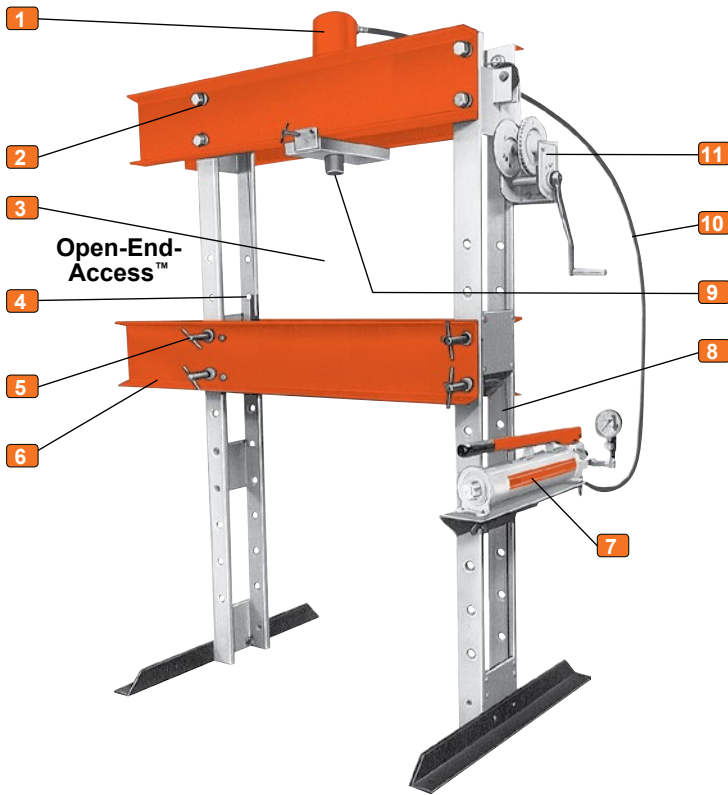

Horizontal pressing capabilities

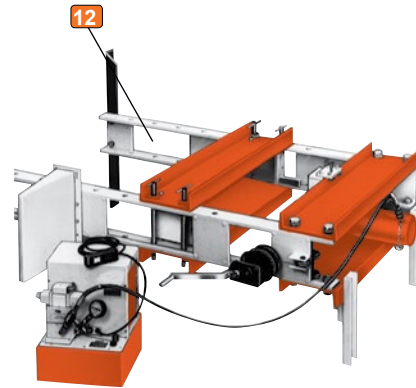

⚠ IMPORTANT SAFETY INFORMATION:
Power Team has protective blankets available which may afford protection from injury to users and others should part breakage occur. Power Team recommends the use of these blankets for all pushing, pulling, pressing, and lifting applications.

- 1 2 TO 1 SAFETY FACTOR**
Hydraulic cylinders meet ASME B30.1 standards. Single or double-acting cylinders are available.
- 2 FULL RATED CAPACITY**
Across width of upper frame, even with work-head moved to one side. (Heavy-duty presses only).
- 3 LARGER WORK AREA** than most competitors' models.
- 4 ALIGNMENT LEVER** for simple pin replacement after raising or lowering the bed.
- 5 CLOSE MANUFACTURING TOLERANCE** allows even load distribution over four alloy steel pins, not two, like some competitors. (Heavy-duty presses only).

- 6 OPEN-END-ACCESS™ FEATURE** on 25 ton press provides additional work area by mounting cylinder on outside for C-frame advantage.
- 7 ELECTRIC, AIR OR HAND HYDRAULIC PUMPS** are available. All are standard Power Team pumps. Externally-adjustable relief valve for precise operator control of working pressure is standard on all electric pumps (except PE10 and PE17 series.)
A 24VAC hand switch for remote control on pumps equipped with solenoid valves.
Note: CSA approved electric pumps are standard on all presses.

- 8 RUGGED UPRIGHTS**, 50 percent stronger than channel iron. Four post design means open side for easy loading of long material.
- 9 FAST CYLINDER APPROACH** to work provided by 2-speed hand, air or electric pumps.
- 10 3/8" I.D. HOSE** on spring return cylinders on heavy-duty presses provides up to six times faster cylinder return than standard 1/4" I.D. hose.
- 11 ONE-PERSON OPERATION** for bed adjustment. Winch unit quickly raises or lowers bed to desired height. Self-locking winch mechanism prevents bed from dropping when handle is released.

- 12 FRAMES CAN BE USED HORIZONTALLY** for pressing jobs on extra-long shafts.
NOTE: Certain features do not apply to Power Team 10 ton, Roll-Bed®, or economy presses.
NOTE: Certain press applications may require guarding. Because of the multitude of possible press uses, it is impossible to design a guard that will meet every customer need. The end-user must provide their own guarding where the situations dictate.

Model Shown:
SPM256C



Shop Equip.

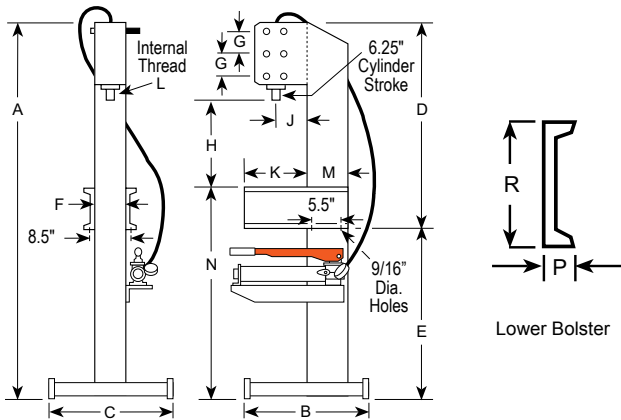

Lower Bolster

>Features

C-FRAME PRESSES

- Open-End-Access™ design makes loading and unloading of work easy.
- Bench mount requires less than 1.5 sq. ft. of space.
- Cylinder head adjusts to three convenient working positions, providing up to 20.25" of "daylight."
- Can be bench-mounted or mounted on optional base.
- Hydraulic cylinder delivers a 6.25" stroke and is driven by a P59 two-speed hand pump.



Optional Pedestal Base



No. 60846 – Provides a stable base for SPM256C. Includes a bracket for mounting the pump on the side of pedestal press. Only 4 sq. ft. of floor space is needed. Wt., 76 lbs.



▶ Technical Dimensions

A	B	C	D	E	F	G	Cyl. Retracted			J	K	L	M	N	P	R	Floor Space
(in.)	(in.)	(in.)	(in.)	(in.)	(in.)	(in.)	(in.)	(in.)	(in.)	(in.)	(in.)	(in.)	(in.)	(in.)	(in.)	(in.)	(in.)
77.63	24.50	24.00	41.63	36.00	6.00	5.00	10.25	15.25	20.25	6.25	12.50	1 1/2 - 16	8.00	43.00	2.00	7.00	24 x 24.50

▶ Ordering Information

Order No.	Cap. (tons)	Type Cyl. Used	Stroke (in.)	Cyl. Model	Speed †† Advance Pressing		Type of Pump	Pump Model	Prod. Wt. (lbs.)
					(in. / stroke)	(in. / stroke)			
SPM256C *	25	Single-Acting	6.25	C256C	0.129	0.03	Hand	P59	240.00
SPX256C *	25	Single-Acting	6.25	C256C	0.129	0.03	—	—	240.00

* SPM256C and SPX256C does not include No. 60846 pedestal base.

†† Typical performance based on pump specifications. Actual speeds may vary with operating conditions.

Model Shown:

SP1010A, SPM1010



Features

H-FRAME

- Ideal for small pressing jobs, repairing small motor armatures, removing and installing gears, bearings, other press-fit parts.
- Bench press has 15.38" x 18" work area. Floor press bed height is adjustable from 5" to 41" with horizontal "daylight" of 21".
- Choices of power sources include: single-speed hand pump, electric/hydraulic or air/hydraulic.
- Hydraulic gauges, hoses and fittings included.



Pump Electrical Specifications

PE10 Series – 1/4 hp, 115VAC, 60 cycle, single-phase. Also available in 230VAC, 50 cycle (add suffix "-220" to order number).

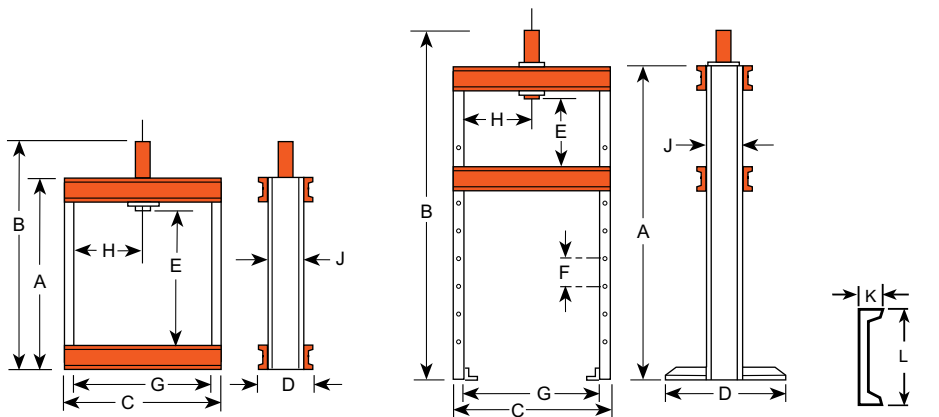

Shop Equip.

Technical Dimensions

Frame	A	B	C	D	E	F	G	H	J	K	L	Bench Space (in.)	Floor Space (in.)
	(in.)	(in.)	(in.)	(in.)	(in.)	(in.)	(in.)	(in.)	(in.)	(in.)	(in.)		
Bench	24.50	33.13	25.25	7.19	15.38	—	22.00	11.00	4.00	1.56	4.00	7.19 x 25.25	—
Floor	59.00	67.63	25.25	28.00	5 - 41	6.00	22.00	2.50 - 18.50	4.00	1.56	4.00	—	28.00 x 28.25

Ordering Information

Order No.	Frame	Cap. (tons)	Type Cyl. Used	Stroke (in.)	Cyl. Model	Speed ††† Advance Pressing		Type of Pump	Pump Model	Prod. Wt. (lbs.)
						(in. / stroke)	(in. / min.)			
SPM1010	222481 Bench	10	Single-Acting	10.13	C1010C	0.06 (in./stroke)	0.06 (in./stroke)	Hand	P55	91.00
SPH1010	222480 Floor	10	Single-Acting	10.13	C1010C	0.06 (in./stroke)	0.06 (in./stroke)	Hand	P55	171.00
SPE1010	222480 Floor	10	Single-Acting	10.13	C1010C	0.53	4.40	Elec. †	PE102	175.00
SP1010A	222480 Floor	10	Single-Acting	10.13	C1010C	0.60	4.00	Air	PA9H	162.00
SPE1010D	222480 Floor	10	Double-Acting	10.00	RD1010	0.53	4.40	Elec. †	PE10	192.00

† "Advance" position holds pressure with motor shut-off. "Return" position advances cylinder with motor running and returns cylinder with motor shut-off.

††† Typical performance based on 100 psi and 10,000 psi pump specifications. Actual speeds may vary with operating conditions.

Model Shown:
SPE256



Features

ECONOMY PRESSES

- Rugged, yet reasonably priced. Handles many “big press” tasks, and perfect for many of the “in-between” jobs you see almost daily.
- Press bed height easily adjustable with winch. Bed will not drop when handle is released.
- Choice of power sources for rapid cylinder advance: two-speed hydraulic hand pump, electric/hydraulic or air/hydraulic. (**Note:** Stroke length limited to 6-1/4” on economy models).



Pump Electrical Specifications

Pump Series	Description
PE17	1/2 hp, 115VAC, 60 cycle, single-phase.
PE21	1 hp, 115VAC, 60 cycle, single-phase.

Both pumps available in 230VAC, 50 cycle, add suffix “-220” to order no.

Shop Equip.

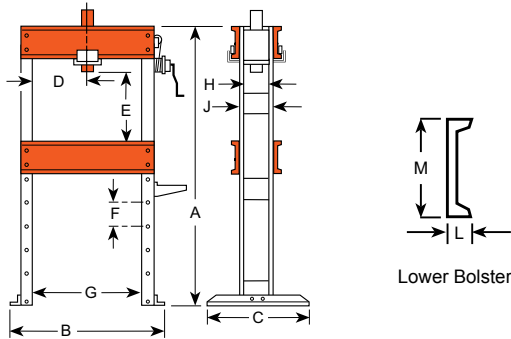

Lower Bolster

Technical Dimensions

A	B	C	D*	E	F	G	H	J	K	L	M	Floor Space
(in.)	(in.)	(in.)	(in.)	(in.)	(in.)	(in.)	(in.)	(in.)	(in.)	(in.)	(in.)	(in.)
58.00	43.00	28.00	3 - 29	6.88 - 43.38	4.50	32.00	5.50	6.50	7.00	2.50	8.00	43 x 28

* Lateral head movement

Ordering Information

Order No.	Cap. (tons)	Type Cyl. Used	Stroke (in.)	Cyl. Model	Speed † † † Advance Pressing		Type of Pump	Valve Type	Pump ‡ Model	Prod. Wt. (lbs.)
					(in. / min)	(in. / min.)				
SPA256	25	Single-Acting	6.25	SPA256	9.8	1.2	Air.	2-Way Foot	PA6	578.00
SPM256	25	Single-Acting	6.25	SPM256	0.129	.129 (in./stroke)	Hand.	Load Release	P59	595.00
SPE256	25	Single-Acting	6.25	SPE256	46.60	3.3	Elec.	2-Way † †	PE172	607.00

† † Holds pressure with motor shut-off. Also has an automatic dump setting. Furnished with a 10' remote motor control.

† † † Typical performance based on 100 psi and 10,000 psi pump specifications. Actual speeds may vary under operating conditions.

‡ Pump standard with press. Other Power Team pumps can be substituted. dBA at idle and 10,000 psi: PE172-67/81 dBA; PE21-70; dBA measured at 3 foot distance, all sides.

Model Shown:
SPE2514

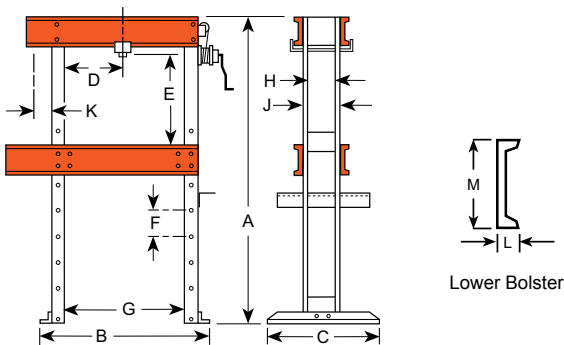

Lower Bolster

Features

OPEN-END-ACCESS™ PRESSES

- Design permits use as both H-Frame and C-Frame press. Cylinder can be mounted on frame extension to handle jobs which won't fit between uprights.
- Open-end-Access™ press models are also available with remote control to enable the operator to view work from all sides with fingertip control of cylinder piston travel.
- Off-center pressing loads of full capacity can be applied across entire width of frame.
- Press bed height easily adjustable with winch. Bed will not drop when handle is released.
- Choice of power sources for rapid cylinder advance: two-speed hydraulic hand pump, electric/hydraulic or air/hydraulic.



Pump Electrical Specifications

Pump Series	Description
PE17	1/2 hp, 115VAC, 60 cycle, single-phase.
PE21	1 hp, 115VAC, 60 cycle, single-phase.

Both pumps available in 230VAC, 50 cycle, add suffix "-220" to order no.

Shop Equip.

Technical Dimensions

A	B	C	D*	E	F	G	H	J	K	L	M	Floor Space
(in.)	(in.)	(in.)	(in.)	(in.)	(in.)	(in.)	(in.)	(in.)	(in.)	(in.)	(in.)	(in.)
58.00	43.00	28.00	3 - 29	6.88 - 43.38	4.50	32.00	5.50	6.50	7.00	2.50	8.00	43 x 28

* Lateral head movement

Ordering Information

Order No.	Cap. (tons)	Type Cyl. Used	Stroke (in.)	Cyl. Model	Speed † † † Advance Pressing		Type of Pump	Valve Type	Pump ‡ Model	Prod. Wt. (lbs.)
					(in. / min)	(in. / stroke)				
SPA2514	25	Single-Acting	14.25	C2514C	9.80	1.2	Air	2-Way Foot	PA6	683.00
SPM2514	25	Single-Acting	14.25	C2514C	0.49 (in./stroke)	0.03 (in./stroke)	Hand	Load Release	P159	693.00
SPE2514	25	Single-Acting	14.25	C2514C	46.60	3.3	Elec.	2-Way † †	PE172	665.00
SPE2514S	25	Single-Acting	14.25	C2514C	52.00	4.0	Elec.	3-Way †	PE213S	759.00
SPE2514DS	25	Double-Acting	14.25	RD2514	52.00	4.0	Elec.	4-Way †	PE214S	787.00

† Solenoid valve with 24VAC remote control hand switch.

† † Holds pressure with motor shut-off. Also has an automatic dump setting. Furnished with a 10' remote motor control.

† † † Typical performance based on 100 psi and 10,000 psi pump specifications. Actual speeds may vary under operating conditions.

‡ Pump standard with press. Other Power Team pumps can be substituted. dBA at idle and 10,000 psi: PE172-67/81 dBA; PE21-70; dBA measured at 3 foot distance, all sides.

Model Shown:
SPE5513DS

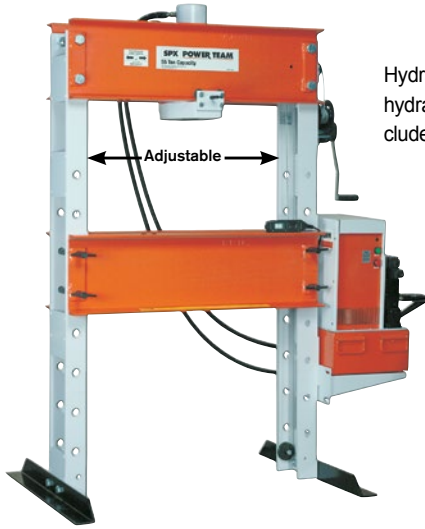

Hydraulic gauge and hydraulic fittings are included with presses.

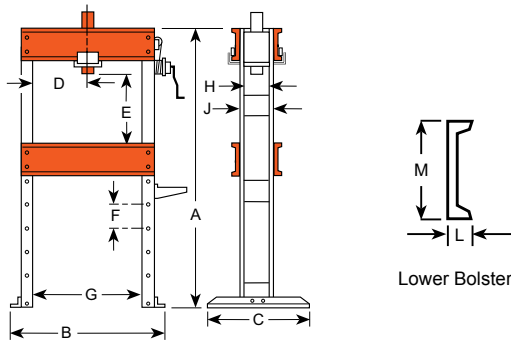

Shop Equip.

Features

H-FRAME SHOP PRESS

- Full off-center pressing at full rated capacity across width of upper frame without buckling or bending.
- Maximum “daylight” is 42” x 36”, making positioning of even bulky work pieces easy.
- Height of press bed is easily adjusted with winch. Friction brake prevents bed from dropping and handle from spinning upon release.
- Presses with single-acting cylinders offer choice of 2-speed hand operated, electric/hydraulic, or air/hydraulic pump. Models with double-acting cylinders have an electric/hydraulic pump.
- Press models equipped with remote control enable operator to view work from all sides with fingertip control of cylinder piston travel.
- Press can be used horizontally for special applications with user-supplied support legs.



Pump Electrical Specifications

Pump Series	Description
PE17 *	1/2 hp, 115VAC, 60 cycle, single-phase.
PE21 *	1 hp, 115VAC, 60 cycle, single-phase.
PQ60 *	2 hp, 230VAC, 60 cycle, single-phase.

* Pumps available in 230VAC, 50 cycle, add suffix “-220” to order no.



Straightening Fixtures



No. SF50 – Straightening fixtures for use with 55-ton shop or 80-ton Roll-Bed® presses (2 ea).. Wt., 104 lbs.

Not part of press, order separately.

Technical Dimensions

A	B	C	D*	E	F	G	H	J	L	M	Floor Space
(in.)	(in.)	(in.)	(in.)	(in.)	(in.)	(in.)	(in.)	(in.)	(in.)	(in.)	(in.)
72.00	48.50	36.00	3.25 - 32.75	6 - 42	6.00	36.00	6.75	8.00	3.00	12.00	48.5 x 36

* Lateral head movement

Ordering Information

Order No.	Cap. (tons)	Type Cyl. Used	Stroke (in.)	Cyl. Model	Speed ††† Advance Pressing		Type of Pump	Valve Type	Pump ‡ Model	Prod. Wt. (lbs.)
					(in. / min)	(in. / min.)				
SPA556	55	Single-Acting	6.25	C556C	4.5	0.5	Air	2-Way Foot	PA6	804.00
SPM556	55	Single-Acting	6.25	C556C	0.23 (in./stroke)	0.015 (in./stroke)	Hand	Load Release	P159	814.00
SPM5513	55	Single-Acting	13.25	C5513C	0.665 (in./stroke)	0.26 (in./stroke)	Elec.	2-Way	P460	960.00
SPE556	55	Single-Acting	6.25	C556C	21.7	1.5	Elec.	2-Way ††	PE172	836.00
SPE556	55	Single-Acting	13.25	C5513C	21.7	1.5	Elec.	2-Way ††	PE172	980.00
SPE5513	55	Single-Acting	13.25	C5513C	24.4	1.9	Elec.	3-Way †	PE213S	1,056.00
SPE5513D	55	Double-Acting	13.25	RD5513	21.7	1.5	Elec.	4-Way	PE174	993.00
SPE5513DS	55	Double-Acting	13.25	RD5513	66.1	5.4	Elec.	4-Way †	PQ604S	1,114.00

† Solenoid valve with 24VAC remote control hand switch.

†† Holds pressure with motor shut-off. Also has an automatic dump setting. Furnished with a 10' remote motor control.

††† Typical performance based on 100 psi and 10,000 psi pump specifications. Actual speeds may vary with operating conditions.

‡ Pump standard with press. Other Power Team pumps can be substituted. dBA at idle and 10,000 psi: PE172—67/81; PE21 Series—70; PQ60—74/76; measured at 3 foot distance, all sides.

Note: Frame is shipped assembled.

Model Shown:
SPE10013DS



Hydraulic gauge and hydraulic fittings are included with presses.

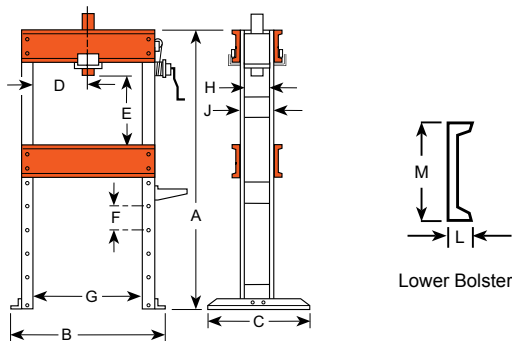

Lower Bolster

Features

H-FRAME SHOP PRESS

- Cylinder work-head glides across upper frame on rollers, locks in place for off-center pressing jobs. May be used horizontally for special pressing applications with user-supplied supports.
- Press bed is raised and lowered by winch which locks in place for insertion of bed retaining pins. Upper bolster can be lowered 8" for convenient positioning on repetitive jobs.
- Generous "daylight" of 42" x 50" accommodates bulky work pieces, uprights are placed for easy side entry of bars or shafts for straightening or bending.
- Choice of single or double-acting cylinder. Hydraulic pump options include: 2-speed hand pump with large 2-gallon reservoir, PE172 electric/hydraulic pump or "PQ" series "Quiet" electric/hydraulic pump with low noise level.



Pump Electrical Specifications

Pump Series	Description
PE17 *	1/2 hp, 115VAC, 60 cycle, single-phase.
PQ60 *†	2 hp, 230VAC, 60 cycle, single-phase.
PQ120 **	3 hp, 460VAC, 60 cycle, three-phase.

* Pumps available in 230VAC, 50 cycle, add suffix "-220" to order no.
† For 115VAC, consult factory.
** Pump available in 220/380VAC, 50 cycle. To order 380VAC, 50 cycle, add suffix "-380" to order no.



Straightening Fixtures



No. SF150 – Straightening fixtures for use with 100 ton shop press and 100, 150, and 200 ton Roll-Bed® presses (2 ea). Wt., 196 lbs.

Not part of press, order separately.

Technical Dimensions

A	B	C	D*	E	F	G	H	J	L	M	Floor Space
(in.)	(in.)	(in.)	(in.)	(in.)	(in.)	(in.)	(in.)	(in.)	(in.)	(in.)	(in.)
77.25	64.00	36.00	7 - 43	2 - 42	8.00	50.00	8.00	10.00	3.38	15.00	36 x 78.25

* Lateral head movement

Ordering Information

Order No.	Cap. (tons)	Type Cyl. Used	Stroke (in.)	Cyl. Model	Speed ††† Advance Pressing		Type of Pump	Valve Type	Pump ‡ Model	Prod. Wt. (lbs.)
					(in. / min)	(in. / stroke)				
SPM10010	100	Single-Acting	10.25	C10010C	0.356 (in./stroke)	0.01 (in./stroke)	Hand	3-Way	P460	1,698.00
SPE10010	100	Single-Acting	10.25	C10010C	35.0	2.9	Elec.	3-Way	PQ603	1,795.00
SPE10010R	100	Single-Acting	10.25	C10010C	11.5	0.8	Elec.	2-Way	PE172	1,690.00
SPE10013DS	100	Double-Acting	13.13	RD10013	35.0	5.8	Elec.	4-Way †	PQ1204S	1,886.00

† Solenoid valve with 24VAC remote control hand switch.

††† Typical performance based on 100 psi and 10,000 psi pump specifications. Actual speeds may vary under operating conditions.

‡ Pump standard with press. Other Power Team pumps can be substituted. dBA at idle and 10,000 psi: PE172—67/81; PQ60—74/76; PQ120—73/78. Measured at 3 foot distance, all sides.

Note: Frame is shipped assembled.

Model Shown:
SPE20013DS



Hydraulic gauge and hydraulic fittings are included with presses.

Shop Equip.

>Features

H-FRAME SHOP PRESS

- Standing 7.5 feet tall, these giants handle the really big jobs.
- May be used horizontally for special pressing applications with user-supplied supports.
- Work-head has wide horizontal travel. Rugged press frame withstands load of rated capacity across full width of frame.
- Winch mechanism provides easy positioning of press bed, locks in place for insertion of retaining pins.
- Upper bolster can be lowered 11" for convenient positioning on repetitive jobs.
- Uprights are placed for easy side entry of bars or shafts for straightening or bending.
- Fast cylinder approach is provided by PQ1204S "Quiet" electric/hydraulic pump.
- Remote control hand switch, enables operator to view work from all sides with fingertip control of cylinder piston travel.



Pump Electrical Specifications

Pump Series	Description
PQ120	3 hp, 460VAC, 60 cycle, three-phase. Also available in 220/380VAC, 50 cycle, add suffix "-380" to order no.

NOTE: To order press with 230VAC, 60 cycle, single-phase pump, order press less PQ1204S. Order pump No. PQ604S separately.



Optional HD Straightening Fixtures



No. SF150 – Straightening fixtures for use with 100 ton shop press and 100, 150, and 200 ton Roll-Bed® presses (2 ea).
Wt., 196 lbs.

Not part of press, order separately.



Adjustable head accommodates a wide array of applications



Winch provides easy positioning of press bed

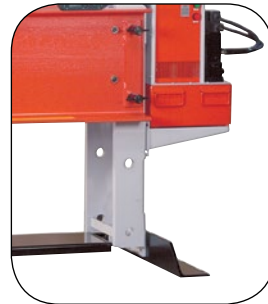

Large footing for a solid base and stability

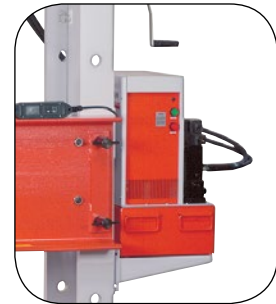

PQ120 Series pump provides the pressure and control

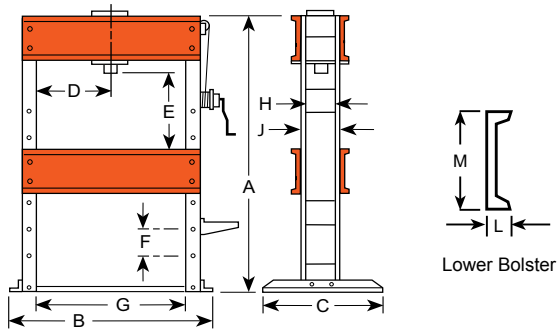

Shop Equip.

▶ Technical Dimensions

A	B	C	D*	E	F	G	H	J	L	M	Floor Space
(in.)	(in.)	(in.)	(in.)	(in.)	(in.)	(in.)	(in.)	(in.)	(in.)	(in.)	(in.)
90.00	71.00	44.00	11 - 39	9 - 43.75	11.00	50.00	12.50	15.00	4.13	18.00	44 x 71

* Lateral head movement

▶ Ordering Information

Order No.	Cap. (tons)	Type Cyl. Used	Stroke (in.)	Cyl. Model	Speed † † † Advance Pressing		Type of Pump	Valve Type	Pump ‡ Model	Prod. Wt. (lbs.)
					(in. / min)	(in. / min.)				
SPE15013DS	150	Double-Acting	13.13	RD15013	24	3.9	Elec.*	4-Way **	PQ1204S	3,015.00
SPE20013DS	200	Double-Acting	13.13	RD20013	18	2.9	Elec.*	4-Way **	PQ1204S	3,276.00

Note: Frame is shipped assembled.

* Pre-wired at factory for 460VAC.

** Solenoid valve with 24VAC remote control hand switch.

† † † Typical performance based on 100 psi and 10,000 psi pump specifications. Actual speeds may vary under operating conditions.

‡ Pump standard with press. dBA at idle and 10,000 psi: 73/78, measured at 3 foot distance, all sides.

Model Shown:
RB10013S



Hydraulic gauge and hydraulic fittings are included with presses.

Shop Equip.

▶ **Roll-bed enables easy loading and unloading of large gears to simplify the pressing operation.**

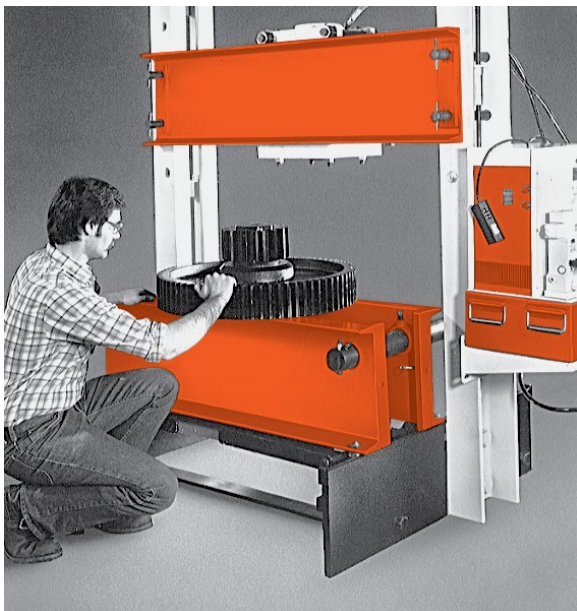

Features

H-FRAME ROLL-BED® PRESS

- The original, patented Roll-Bed® extends out for easy loading and unloading with a crane or other lifting device, supporting loads up to 3,000 lbs.
- Movable work-head glides easily side-to-side for full off-center load capacity across width of upper frame.
- "Daylight" is 50.5" x 60" for 80 and 100 ton models; 51.25" x 64" on 150 and 200 ton presses.
- Fast approach of double-acting, 13.125" stroke cylinder is provided by PQ1204S "Quiet" electric/hydraulic pump with remote control hand switch. Operator can view work from all sides with fingertip control of cylinder piston travel.
- Adjustable lower bed width for secure balancing and centering of heavy jobs.
- Lifting mechanism has a turn crank handle to raise or lower upper bolster (a heavy-duty 1/2" drill motor can replace handle for automatic adjustment). Four locking pins hold bolster in place for pressing.



Optional HD Straightening Fixtures



No. SF50 – Straightening fixtures for use with 55-ton shop or 80 ton Roll-Bed® presses (2 ea). Wt., 104 lbs.

Not part of press, order separately.



No. SF150 – Straightening fixtures for use with 100 ton shop press and 100, 150, and 200 ton Roll-Bed® presses (2 ea). Wt., 196 lbs.

Not part of press, order separately.



Pump Electrical Specifications

Pump Series	Description
PQ120	3 hp, 460VAC, 60 cycle, three-phase. Available in 220/380VAC, 50 cycle, add suffix "-380" to order no.

NOTE: To order press with a 230VAC, 60 cycle, single-phase pump, order press less PQ1204S. Order pump No. PQ604S separately.

NOTE: Different voltage and valve options can be obtained by substituting certain PA, PE or PQ series pumps. Consult the factory.



Lifting screw and locking pins make bolster raising a one-man job.



Bearings make bed positioning smooth and easy.



Lever lowers bed for pressing, raises it for rolling.



Cylinder is easily moved across width of upper bolster.

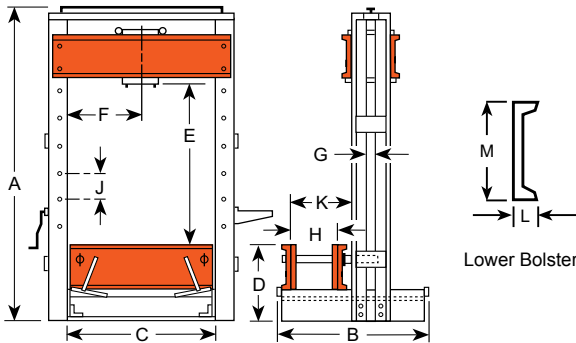

Width adjusts from 4" to over 27" & is secured with locking bolts.

Shop Equip.

Technical Dimensions

Cap. (Tons)	A (in.)	B (in.)	C (in.)	D (in.)	E (in.)	F (in.)	G (in.)	H (in.)	J (in.)	K (in.)	L (in.)	M (in.)	Floor Space (in.)
80	112.63	64.25	50.50	27.00	12 - 60	14.50 - 36.00	3.00	4.00 - 27.25	8.00	36.50	3.38	15.00	64.25 x 60.50
100	112.63	64.25	50.50	27.00	12 - 60	14.50 - 36.00	3.00	4.00 - 27.25	8.00	36.50	3.38	15.00	64.25 x 60.50
150	123.25	68.25	51.25	30.00	9 - 64	13.88 - 37.88	3.00	4.00 - 27.13	11.00	37.25	4.13	18.00	68.25 x 63.25
200	122.25	68.25	51.25	30.00	9 - 64	15.13 - 36.13	3.00	4.00 - 27.13	11.00	37.25	4.13	18.00	68.25 x 63.25

Ordering Information

Order No.	Cap. (tons)	Type Cyl. Used	Stroke (in.)	Cyl. Model	Speed † † † Advance Pressing		Type of Pump	Valve Type	Pump ‡ Model	Prod. Wt. (lbs.)
					(in. / min)	(in. / min.)				
RB8013S	80	Double-Acting	13.13	RD8013	46	7.5	Elec.	4-Way †	PQ1204S	2,886.00
RB10013S	100	Double-Acting	13.13	RD10013	35	5.8	Elec.	4-Way †	PQ1204S	2,944.00
RB15013S	150	Double-Acting	13.13	RD15013	24	3.9	Elec.	4-Way †	PQ1204S	4,458.00
RB20013S	200	Double-Acting	13.13	RD20013	18	2.9	Elec.	4-Way †	PQ1204S	4,546.00

Note: Frame is shipped assembled.

† Solenoid valve with 24VAC remote control hand switch.

††† Typical performance based on 100 psi and 10,000 psi pump specifications. Actual speeds may vary with operating conditions. 3,000 lbs. maximum load can be supported on bed when raised on the rollers.

‡ Pump standard with press. dBA at idle and 10,000 psi: PQ120-73/78; measured at 3 foot distance, all sides.

RUBBER TIRE REMOVING/INSTALLING SET



Pressing rim into new tire on Power Team Press.

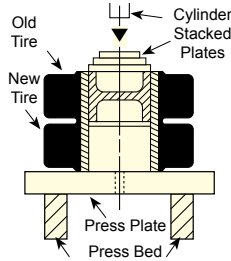

Now an easy way to press solid rubber tires. The TPP200 uses plates instead of combination rings to press a rim from an old tire into a new one. P They can be used on any Power Team press with 55 ton capacity or more.

NOTE: Many tires require 100 tons of force or more, depending on tire size and condition. These plates withstand maximum force of 150 tons.

Order No.	Description
TPP200	Tire press plate set. Includes 13 press plates, spacer pushing adapter and press bed plate.
NOTE: For use on solid rubber tires from 4" to 17 - 3/4" I.D.	

TIRE PRESS PLATE SET, TPP200

Model Shown:

TBP1622, TPP1 - TPP13, TPS6

Shop Equip.



Order No.	Tire Size I.D. (in.)	Tire Size O.D. (in.)
TPP1	4	3.88
TPP2	5	4.88
TPP3	6, 6.25	5.88
TPP4	6.50	6.38
TPP5	8	7.88
TPP6	10	9.88
TPP7	10.50	10.38
TPP8	11.25	11.13

Order No.	Tire Size I.D. (in.)	Tire Size O.D. (in.)
TPP9	12, 12.13	11.88
TPP10	14	13.88
TPP11	15	14.88
TPP12	16	15.88
TPP13	17.75	17.63
TPS6	Spacer/Pushing Adapter	3.75 x 6
TBP1622	Bed Plate	16 x 22 x 2

"V" BLOCKS

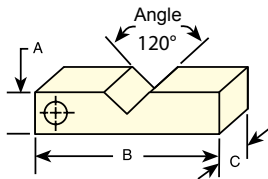

Order No.	Width	Length	Thick
	A (in.)	B (in.)	C (in.)
1890	2.00	9.00	1.25
1891	2.50	11.50	1.75
1892	3.50	14.00	2.00
1893	5.00	14.00	1.50
207395	5.75	23.00	2.50

THREAD ADAPTER

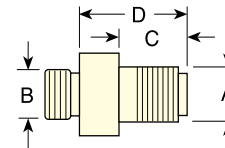

Order No.	A (in.)	B (in.)	C (in.)	D (in.)
38597	1 - 8	1 - 8	0.75	1.31
38953	1.25 - 7	1.5 - 16	2.75	4.38
37368	1.63 - 5.5	—	1.69	2.50
43562	2.25 - 12	—	2.25	3.00
38954	1.63 - 5.5	1.69 - 8	3.25	4.19
43563	2.25 - 12	2.75 - 12	2.25	3.19
46070	2.25 - 12	2 - 4.5	2.25	3.19

PRESS ACCESSORY KIT

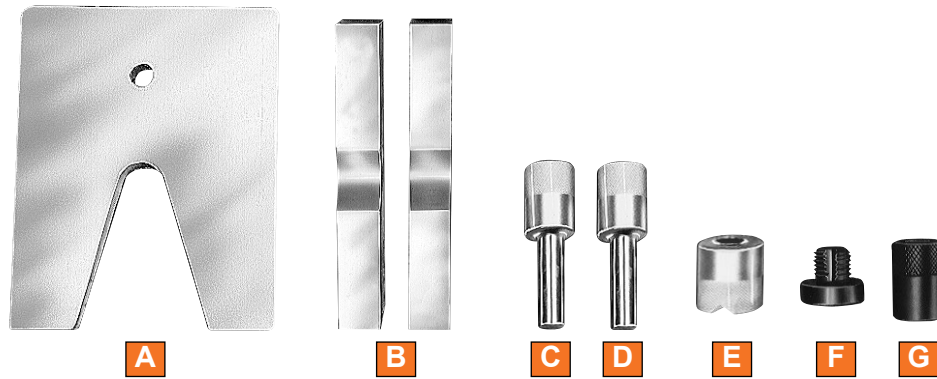

Make your Power Team press even more versatile with one of these accessory sets. These sets will eliminate makeshift set-ups. Many of these items can be used with pullers you already have.

Ordering Information

Use With Press (Ton)	Order No.	V-Throat Press Plate	V-Blocks	Pushing Adapter ⚠	Pushing Adapter ⚠	V-Pushing Adapter	Threaded Adapter		Pushing Adapter
							Single-Acting Cyls.	Double-Acting Cyls.	
							F		
10	SPA10	1888	1890 (2)	201923 1/2" Dia. Shank	201454 3/4" Dia. Shank	34806	38597 †	38597 †	—
25	SPA25	1889	1891 (2)	34510 3/4" Dia. Shank	34511 1" Dia. Shank	34807	38953 ††	38953 ††	—
55	SPA55	—	1892 (2)	34755 1" Dia. Shank	34756 1 1/2" Dia. Shank	34808	37368 ††	38954 ††	—
80/100	SPA100	—	1893** (2)	—	—	36469	43562 †† 46070 ††	43563 †† 46070 ††***	21332
150/200	SPA200	—	207395 (2)	—	44458* 2 1/4" Dia. Shank	44457	—*	—	—

† Included in Set

†† Not Included, Order Separately

* Pushing adapters thread directly into RD15013 and RD20013 cylinders.

** V-blocks, 1893, are recommended for use with 80 ton Roll-Bed® press. Not recommended for use with 100 ton Roll-Bed® press.

*** For 80 ton Roll-Bed® press.

⚠ CAUTION: Pushing adapters are designed for use with specific shaft sizes, and depending on the condition of the shaft ends, the adapter may not withstand the full press tonnage. Always use a protective blanket or other suitable guard when pressing.

Shop Equip.

Model Shown:
FC2200



Shop Equip.

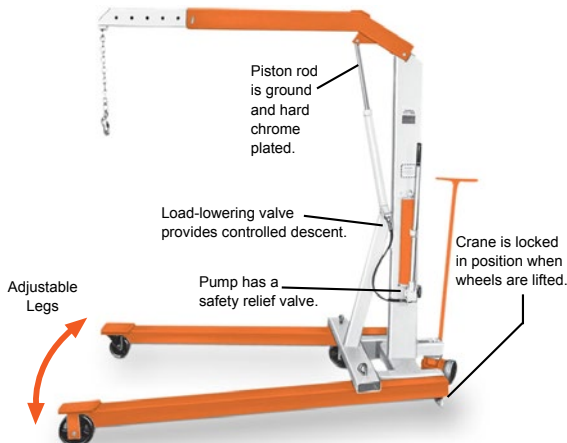
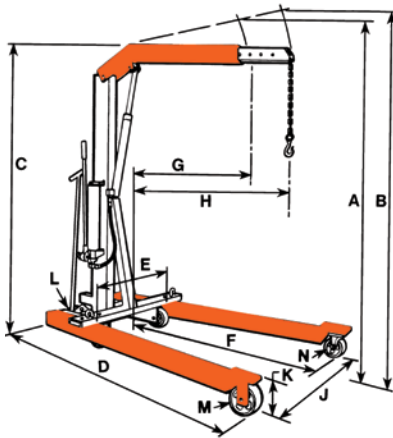

Features

Mobile Floor Cranes

- Adjustable legs spread to clear obstacles (telescoping boom for extra reach)
- Rugged construction, reliable hydraulics.
- Boom collapses completely and legs fold for compact space-saving fold-away storage
- 2-speed hydraulic hand pump provides fast boom travel and precise operator controlled descent.
- Roller bearing wheels and a steering dolly provide ease of mobility. Lifting chain is included.
- U.S. Patent No. 3,367,512

Technical Dimensions

	Description	FC2200	FC4400
A	Max. boom height (ret.)	107"	111"
B	Max. boom height (ext.)	117"	122"
C	Overall height, boom horizontal	80"	82"
D	Overall length	83"	89"
E	Min. throat width	24"	25"
F	Inside leg length	54"	57.5"
G	Eff. boom reach (ret.)	33"	35.5"
H	Eff. boom reach (ext.)	48"	50.5"
J	Inside leg width	24" - 36" - 48" (3-Position)	26" - 40" - 52.5" (3-Position)
K	Leg height	8"	9.5"
L	Dolly wheel diameter	5"	5"
M	Wheel diameter	6"	8"
N	Caster diameter	6"	6"
	Floor space, folded	27" x 38"	31" x 42"
	Height, folded	79"	86"
	Cap. boom ret. (lbs.)	2,200	4,400
	Cap. boom ext. (lbs.)	1,650	3,300

Ordering Information

Order No.	Description
FC2200	2,200 lbs. cap. crane with fold-away feature, adj. leg spread, lifting chain and 2-speed hand pump. Wt., 454 lbs.
FC4400	4,400 lbs. cap. crane with fold-away feature, adj. leg spread, lifting chain and 2-speed hand pump. Wt., 646 lbs.

Model Shown:

LR2000, LR4000, LR6000

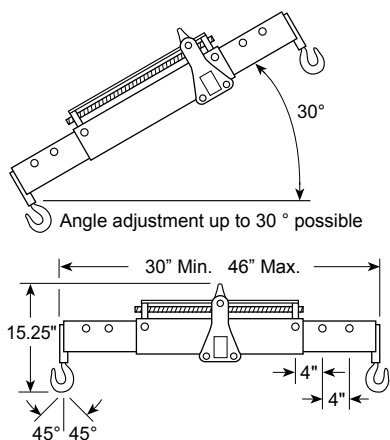

The working length is adjustable in three positions from 30" to 46". Maximum chain angle is 45°

Features

Whenever you have big, heavy components to move or position, nothing helps you get the job done easier and faster than Power Team's Load-Rotors®

- The heavy-duty Load-Rotors®, when used with a crane or hoist, greatly reduce time and effort.
- LR2000 (2,000 lbs. cap.) and LR4000 (4,000 lbs. cap.) heavy-duty lifting slings are just right, for lifting or positioning components.
- LR6000 has a self-locking worm and gear set in the Spread-Tilter™ head permits rapid angle adjustment of the component being handled.



CAUTION

This system should not be used for overhead lifting.

Shop Equip.

Ordering Information

Order No.	Cap.	Chain Size	Chain Lg. with Swivel Hooks	Lifting Eye Opening	Hex Drive End	Gear Ratio	Prod. Wt.
	(lbs.)	(in.)	(in.)	(in.)	(in.)		(lbs.)
LR2000	2,000	0.25	56.00	1.25	0.63	34:1	9.00
LR4000	4,000	0.31	65.00	1.75	0.63	82:1	23.00
LR6000	6,000	0.31	65.00	1.63	0.63	82:1	73.00

JACKS

SELECT FROM A WIDE RANGE OF LIFTING JACK PRODUCTS AND MAINTENANCE SETS TO COMPLETE YOUR SYSTEM REQUIREMENTS

- A hydraulic jack is a powerful lifting or pushing tool designed to provide effective lift over greater distances than a basic mechanical jack.
- Non-inflated air jacks are less than 1" thick, making lifting tasks in small spaces seem routine, tonnages up to 75.3 tons.
- Turnkey maintenance sets offer matched hydraulic system components, adapters and hydraulic spreader, contained in a rugged carrying and storage case.
- Specialty hydraulic jacks support post tension, low height or clearance applications.
- Portable high tonnage jacks are totally self-contained, their modular design allows you to change lifting modules to suit your tonnage or height requirements.





	Section / Series	Page Content	Tonnage Range	Pages
	Introduction	Choosing the Right Jack	—	165-166
	9	Sidewinder Mini Jacks	5 - 20	167
		Low Profile Bottle Jacks	12, 20 & 30	168
		Portable Hydraulic Power Bottle Jacks	2 - 110	169
		Telescoping Bottle Jacks	6-13	170
	J	Toe Jacks	5.5, 11 & 27.5	171
		Economy Toe Jacks	2.5 & 10	172
	RJ	Portable Railroad Edition Jacks and Accessories	100	173-174
		Portable High Tonnage Railroad Jacks and Accessories	55, 100, 150	175-176
	IJ	Inflatable Jacks	1 - 75	177-178
	IJ Accessories	Inflatable Jack Accessories	-	179
	IM	Maintenance Sets	10	180
	SK	10 and 25 Ton Start-Up Kits	10 & 25	181-182
	SJ	Post-Tension and Stressing Jacks and Accessories	20 & 30	183-184



SELECTING THE RIGHT JACK:

Step 1: Select the style jack that best suits the application and your intended lift.

Step 2: How much clearance, or open space, is available? What is the minimum height?

Step 3: How much lift, or extension, is required for the load? What is the tonnage needed?

JACK SIZING CONSIDERATIONS:

1. What do you need to lift?

Depending on the vehicle or machine you need to lift, you will require appropriate equipment. You don't lift a 20 ton truck with the same equipment you would use to lift a 2 ton vehicle.

To choose the right fit, first look at the hydraulic jack capacity. Today, on the market, you can find various sizes of hydraulic jacks, with a lifting capacity going from 1 ton to 300 tons, and even more.

2. What is the free space available?

The best jack in the world is useless if you can't place it under the load. Nowadays, application start height is getting lower and lower, requiring a more compact equipment.

Ground clearance is an important parameter to consider, you need to be able to place the jack without damaging the load.

3. What is the maximum lifting height you would need?

To make the best choice, compare the number of strokes and maximum height of each hydraulic jack.

In addition, ask the how many extensions are available with the hydraulic jack. Some of the equipment has 1 or 2 additional extensions, which will cover more applications with the same equipment.

JACK SERIES:

Hydraulic Bottle Jacks

Choose from this complete line of premium quality, standard bottle jacks. Ideal for use in any number of industrial lifting and pushing applications.

Tonnage Range: 2-110





Inflatable Jacks

Inflatable jacks are easy to use, low maintenance, and lightweight enough to be carried under your arm and moved around in any type of equipment, ideal for mining, vehicle and forklift equipment maintenance and many other uses where your start up height is under a couple of inches.

Non-inflated jacks are less than 1" thick, making lifting tasks in small spaces seem routine.

Tonnage Range: 1.1 - 75.3



Maintenance Sets

Matched hydraulic system components, adapters and a hydraulic spreader, contained in a rugged carrying and storage case. Portable sets are ideal for pushing, pulling, lifting, straightening, or clamping at remote job sites.

Types: Manual or electric drive maintenance sets

Tonnage Range 10 - 25



Portable High Tonnage Jacks

Totally self-contained, modular design allows you to change lifting modules to suit your tonnage or height requirements.

Tonnage Range: 55 - 300

Model Shown:

9210A, 9220A, 9105A, 9205A



Features

COMPACT SIDEWINDER MINI JACK FITS IN YOUR PALM AND DELIVERS 5, 10 & 20 TONS OF LIFTING FORCE.

- Retracted height of just 2.56" for the smallest jack and 5.13" for the 20 ton, allows you to slip this jack into the narrowest of crevices.
- Jacks operate either horizontally or vertically. Handles function in line with base for easier use in confined spaces.
- The perfect addition to any toolbox, this remarkable little jack has multiple uses that are limited only by your imagination. Use it as a jack, or a spreader. Use it to turn your mechanical gear puller (note: puller capacity must match jack capacity) into a hydraulic puller.
- High strength piston and pump linkage for long life.
- All models include over-travel protection.
- Lever Bar included on all models.
- All jacks meet ASME B30.1 standards and carry the Power Team PowerThon™ Lifetime Warranty.

9105A Sidewinder jack is the ideal choice for straightening this crushed box steel .



Jacks

Ordering Information

Order Number	Cap. (tons)	Stroke (in.)	Retracted Height (in.)	Max. Height (in.)	No. Pump Strokes to Ext. Piston	Saddle Dia. (in.)	Base Size Dia. (in.)	Pump Handle Length (in.)	Handle Effort at Rated Cap. (lbs.)	Carry Handle	Prod. Wt. (lbs.)
9105A	5	0.75	2.50	3.38	30	1.14	2.91	9.44	57	No	4.20
9205A	5	1.50	3.50	5.13	38	1.14	2.91	9.44	57	No	5.30
9210A	10	1.19	4.75	5.88	36	1.66	4.33	17.33	62	No	12.10
9220A	20	1.19	5.13	6.31	46	2.08	4.72	23.81	77	No	17.60

Model Shown:

9012A, 9020A, 9130A



Features

THE RIGHT CHOICE FOR THOSE LOWER CLEARANCE JOBS OR APPLICATIONS

- All the quality, features and lifting capacity of the standard jacks in short form. The 12 ton and 20 ton models feature screw extensions for added versatility.
- All jacks operate both vertically and horizontally for use in a variety of lifting, pushing and spreading applications.
- Large base area for increased strength and stability during lifting.
- High strength piston and pump linkage for long life.
- All models include over-travel protection.
- Lever Bar included on all models.
- All jacks meet ASME B30.1 standards and carry the Power Team PowerThon™ Lifetime Warranty.

9130A Low Profile Hydraulic Bottle Jack provides the lifting capacity and low height for this underground mining application.



Jacks

Ordering Information

Order Number	Cap. (tons)	Stroke (in.)	Retracted Height (in.)	Length of Screw Ext. (in.)	Height with Screw Ext. (in.)	No. Pump Strokes to Ext. Piston ‡	Saddle Dia. (in.)	Base Size (in.)	Pump Handle Length (in.)	Handle Effort at Rated Cap. (lbs.)	Carry Handle	Prod. Wt. (lbs.)
9012A	12	3.75	6.75	3	13.50	26	1.88	6.50 x 4.19	23.81	60	Yes	14.00
9020A	20	3.38	7.13	1.56	12.00	22	2.00	7.19 x 5.06	31.50	70	Yes	22.22
9130A	30	3.13	7.13	—	10.25	35	2.38	7.56 x 5.56	39.38	50	Yes	30.20

‡ 2 Speed: Rapid advance≈40 strokes; Lift mode≈160 strokes.

Model Shown:

9030A, 9008A, 9112A



Features

IDEAL FOR INDUSTRIAL LIFTING AND PUSHING APPLICATIONS FOR MRO

- Choose from this complete line of premium quality bottle jacks. Ideal for use in any number of industrial lifting and pushing applications.
- The 9110B, 9015B, 9022B and 9033B feature a beveled base which allows the jack to “follow” the load, reducing the chance of dangerous side-loading.
- Jacks feature a screw extension for quicker setup.
- High strength piston and pump linkage for long life.
- All models include over-travel protection.
- Lever Bar included on all models. All jacks can be used in the vertical, angled or horizontal positions.
- Serrated or contoured saddles help stabilize the load for a safer lift.
- 110 ton jack features dual pumps for time-saving two-speed operation.
- All jacks meet ASME B30.1 standards and carry the Power Team PowerThon™ Lifetime Warranty.

Ordering Information

Order Number	Cap. (tons)	Stroke (in.)	Retracted Height Min. (in.)	Length of Screw Ext. (in.)	Height with Screw Ext. (in.)	No. Pump Strokes to Ext. Piston	Saddle Dia. (in.)	Base Size (in.)	Pump Handle Length (in.)	Handle Effort at Rated Cap. (lbs.)	Carry Handle	Prod. Wt. (lbs.)
9002A	2	4.50	7.13	1.94	13.56	5	1.00	4.69 x 2.56	12.25	75	No	4.80
9003A	3	4.50	7.50	2.38	14.38	10	1.13	4.50 x 2.84	19.25	45	No	5.80
9005A	5	4.75	7.88	2.75	15.38	12	1.38	5.19 x 3.00	21.44	55	No	8.00
9008A	8	4.75	7.88	2.75	15.38	18	1.50	6.00 x 3.50	23.81	75	No	12.1
9112A	12	5.88	9.50	3.13	18.50	26	1.88	6.50 x 4.19	23.81	60	Yes	17.50
9015B	15	6.13	9.06	4.50	19.88	27	2.38	5.13 x 5.50 †	27.56	90	No	18.30
9120A	20	6.25	10.63	3.63	20.50	22	2.00	7.19 x 5.06	31.50	70	Yes	28.50
9022B	22	6.13	9.44	4.31	20.50	36	2.38	6.50 x 6.31 †	27.56	90	Yes	23.60
9030A	30	6.25	11.00	—	17.25	35	2.38	7.56 x 5.56	39.38	50	Yes	41.20
9033B	33	5.63	9.44	4.19	19.75	56	2.56	7.25 x 6.94 †	27.56	88	Yes	32.00
9050A	50	6.75	12.00	—	18.75	36	3.00	9.31 x 7.38	39.38	85	Yes	78.00
9110B	110	6.13	11.81	—	17.94	40/160 ‡	4.38	13.38 x 11.44	27.56	79	Yes	154.30

† Comes with a Beveled Base.

‡ 2 Speed: Rapid advance≈40 strokes; Lift mode≈160 strokes.

Model Shown:
9006X, 9011X, 9013X



Features

THE RIGHT CHOICE FOR THOSE LOWER HEIGHT APPLICATIONS FOR MRO.

- Telescoping jacks offer all of the quality features and capabilities of the standard bottle jack line with a bonus. The super-long stroke of these jacks saves time and effort by eliminating the need to lift or crib. In most applications, the user can place the jack once and complete the lift.
- The 9006X, 9011X and 9013X all feature a unique beveled base that allows the jack to “follow” the load laterally as it is raised, greatly reducing side-loading of the piston.
- High strength piston and pump linkage for long life.
- All models include over-travel protection.
- Lever Bar included on all models.
- All jacks meet ASME B30.1 standards and carry the Power Team PowerThon™ Lifetime Warranty.

Ordering Information

Order Number	Cap. (tons)	Stroke (in.)	Retracted Height (in.)	Length of Screw Ext. (in.)	Height with Screw Ext. (in.)	No. Pump Strokes to Ext. Piston	Saddle Dia. (in.)	Base Size Beveled Base (in.)	Pump Handle Length (in.)	Handle Effort at Rated Cap. (lbs.)	Carry Handle	Prod. Wt. (lbs.)
9006X	6	12.00	8.50	—	20.50	14	1.75	4.75 x 5.25	27.56	79	No	14.00
9011X	11	10.30	7.88	2.69	20.88	25	1.63	6.31 x 6.50	27.56	88	No	19.50
9013X	13	10.00	9.06	3.31	22.44	35	1.88	6.94 x 7.31	27.56	79	Yes	25.00

Model Shown:
J24T, J55T, J106T

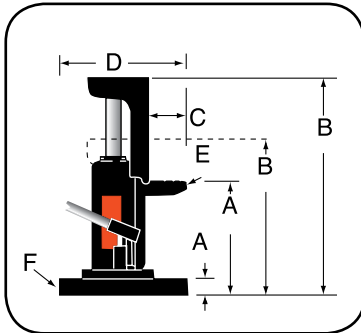

Jacks

Features

LOW HEIGHT INDUSTRIAL LIFTING AND PUSHING APPLICATIONS.

- These bottle jack-style toe jacks are loaded with many of the same features as our standard bottle jacks, but the toe-lift feature and swiveling pump handle socket make them ideal for machinery lifting and positioning.
- An internal pressure relief provides added safety by limiting the jack's lifting capability to the capacity of the toe.
- Spring return is an added feature on the J55T and J106T jacks.
- Swiveling pump handle assembly available on the 5 and 10 ton models. The swiveling jack assembly allows you to access and pump the unit from numerous positions.
- High strength piston and pump linkage for long life.
- All models include over-travel protection.
- Lever Bar included on all models.
- All jacks meet ASME B30.1 standards and carry the Power Team PowerThon™ Lifetime Warranty.

Technical Dimensions

Order Number	Ret.	Ext.	Ret.	Ext.	C	D	E	F
	A		B					
	(in.)	(in.)	(in.)	(in.)				
J24T	0.63	5.50	9.25	14.00	1.88	7.13	2.00	4.94
J55T	1.00	5.88	11.50	16.38	1.88	10.13	3.00	7.25
J106T	1.25	7.13	12.88	18.75	2.50	11.50	3.94	9.50

Ordering Information

Order Number	Cap.	Max. Lift Stroke	Strokes to Ext. Piston	Handle Effort at Max. Load	Carry Handle	Prod. Wt.
	(tons)	(in.)	(1 in.)	(lbs.)		(lbs.)
J24T	2	4.75	14	42.00	Yes	18.30
J55T	5	4.88	22	60.00	Yes	53.00
J106T	10	5.88	31	73.00	Yes	83.80

Model Shown:

J259T, J1095, J58T



Features

HEAVY-DUTY, LOW HEIGHT INDUSTRIAL LIFTING AND PUSHING APPLICATIONS.

- With lifting points on the toe and on the top, these extremely rugged jacks are ideal for machine lifting, rigging, lift truck service and much more.
- Choose from 5.5 ton, 11 ton, or the 27.5 ton lifting capacity.
- All jacks operate both vertically and horizontally.
- Base, toe and pumping assembly swivel independently, allowing the jack to work in confined areas.
- High strength piston and pump linkage for long life.
- Lever Bar included on all models.
- All jacks meet ASME B30.1 standards and carry the Power Team PowerThon™ Lifetime Warranty.

▶ J58T hydraulic toe jack is the perfect choice for the pallet jack application.

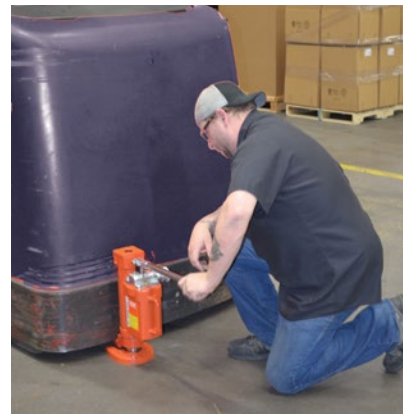
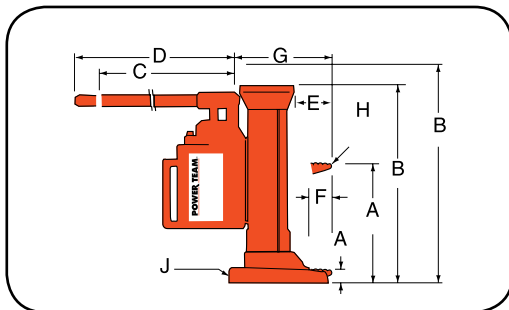

Technical Dimensions

Order Number	Ret.	Ext.	Ret.	Ext.	C	D	E	F	G	H	J
	A		B								
	(in.)	(in.)	(in.)	(in.)							
J58T	1.06	9.38	14.75	23.00	14.50	17.75	2.81	2.19	6.94	1.63	5.13
J109T	1.06	10.38	16.50	25.75	14.50	17.75	3.00	2.19	7.22	2.50	6.75
J259T	2.13	11.38	19.88	29.06	8.25	29.75	5.75	4.00	10.50	3.50	10.63

Ordering Information

Order Number	Cap.	Max. Lift Stroke	Strokes to Ext. Piston	Handle Effort at Max. Load	Carry Handle	Prod. Wt.
	(tons)	(in.)	(1 in.)	(lbs.)		(lbs.)
J58T	5.50	8.25	8.00	83.90	Yes	43.00
J109T	11.00	9.25	13.00	88.00	Yes	64.00
J259T	27.50	9.19	21.00	88.00	Yes	203.00

Model Shown:
RJ100T24E

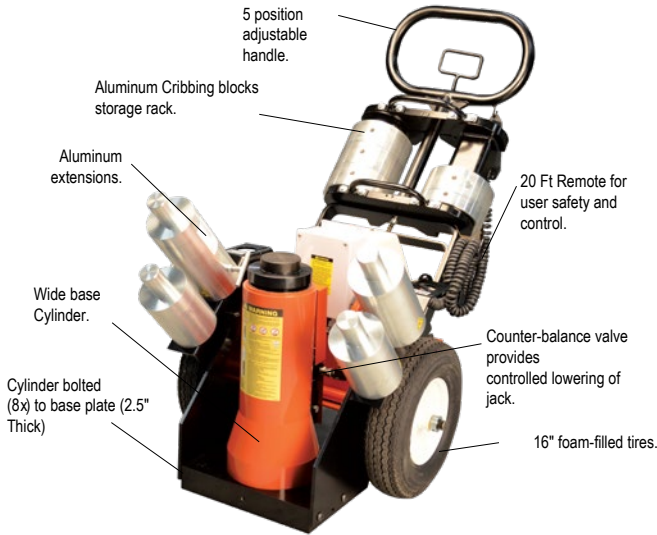

Features

HEAVY-DUTY SELF-CONTAINED INDUSTRIAL LIFTING JACK FOR RAIL MAINTENANCE.

- Wide base cylinder design for stability.
- Double-acting cylinder with locking collar.
- The bottom of the cylinder is a bolted joint, using the base plate as part of the cylinder. This will allow for service of even the oldest or most abused jacks.
- Cribbing storage rack location is such that it allows easy access during cribbing placement and removal.
- Jack has a 20 ft. remote pendant for user safety and control.
- Easy to maneuver, large tires and small footprint make it easy to get into tight spaces.
- Adjustable handle, allows the user to easily to position the jack under loads.

Technical Specifications

Type of Pump	Low Pressure Pump		High Pressure Pump		Current Draw at Max. Internal Relief Settings (amps)	Unload Pressure (psi.)	Internal Relief Pressure (psi.)	Tank (gal.)	Valving
	Flow (cu. in. / min.)	Pressure (psi.)	Flow (cu. in. / min.)	Pressure (psi.)					
Electric	440	440	48	10,000	25	540 - 780	10,000	2	4-Way / 3-Pos. Tandem Center Manual
Air	330		30		NA				

Ordering Information

Order Number	Description	Stroke (in.)	Retracted Height
			A (1 in.)
RJ100T24E	Jack, 100 Ton RR 24" Ret, Elect	14	24
RJ100T37E	Jack, 100 Ton RR 37" Ret, Elect	27	37
RJ100T24A	Jack, 100 Ton RR 24" Ret Air	14	24
RJ100T37A	Jack, 100 Ton RR 37" Ret Air	27	37
RJ100T24A-C*	Jack, 100 Ton RR 24" Ret Air w/Crib Block	14	24
RJ100T24E-C*	Jack, 100 Ton RR 24" Ret Elect w/Crib Block	14	24
RJ100T37A-C*	Jack, 100 Ton RR 37" Ret Air w/Crib Block	27	37
RJ100T37E-C*	Jack, 100 Ton RR 37" Ret Elect w/Crib Block	27	37
RJ100T24A-E**	Jack, 100 Ton RR 24" Ret Air w/Ext	14	24
RJ100T24E-E**	Jack, 100 Ton RR 24" Ret Elect w/Ext	14	24
RJ100T37A-E†	Jack, 100 Ton RR 37" Ret Air w/Ext	27	37
RJ100T37E-E†	Jack, 100 Ton RR 37" Ret Elect w/Ext	27	37

* C models include RJ-CB-S crib set

** 24" - E models include RJ-EXT-S1 set

† Shipping weights 37" - E version includes RJ-EXT-S set

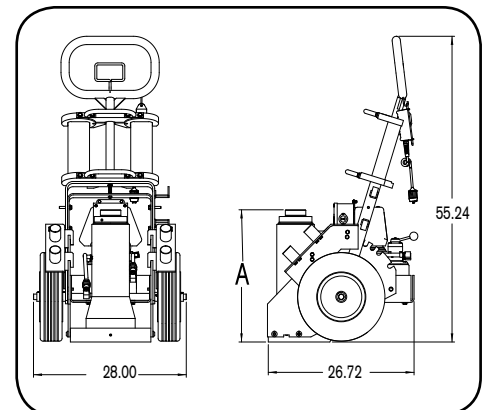

EXTENSIONS



Order No.	Description
RJ-EXT18	Assembly, Extension 18 in. 100 Ton RR Jack
RJ-EXT14	Assembly, Extension 14 in. 100 Ton RR Jack
RJ-EXT11	Assembly, Extension 11 in. 100 Ton RR Jack
RJ-EXT9	Assembly, Extension 9 in. 100 Ton RR Jack
RJ-EXT7	Assembly, Extension 7 in. 100 Ton RR Jack
RJ-EXT5	Assembly, Extension 5 in. 100 Ton RR Jack
RJ-EXT-S	Set, Extensions 100 Ton RR Jack 5, 7, 9
RJ-EXT-S1	Set, Extensions 100 Ton RR Jack 5, 11, 18

CRIBBING BLOCKS



Order No.	Description
RJ-CB10	Assembly, Crib Block 10 in. 100 Ton RR Jack
RJ-CB5	Assembly, Crib Block 5 in. 100 Ton RR Jack
RJ-CB3	Assembly, Crib Block 3 in. 100 Ton RR Jack
RJ-CB1	Assembly, Crib Block 1 in. 100 Ton RR Jack
RJ-CB-S	Set, Crib Blocks 100 Ton RR Jack 1, 3, 5, 10

SPACERS



Order No.	Description
RJ-SP-1	Spacer, 1 in.
RJ-SP-2	Spacer, 2 in.
RJ-SP-3	Spacer, 3 in.
RJ-SP-S	Spacer Set 100 ton RR Jack 1, 2, 3

SWIVEL CAPS



Order No.	Description
RJ-SC-1	Assembly, Swivel Cap 100 Ton RR Jack
RJ-SC-2	Assembly, Swivel Cap 100 Ton RR Jack Long

Jacks

Model Shown:

JEM5526, PMA55S, PME55S



Air pump and cart module.

Electric pump and cart module.

Features

PORTABLE AND COMPACT, IDEAL FOR LOCOMOTIVE/RAIL CAR, MINING AND HEAVY EQUIPMENT MAINTENANCE.

- Modular design allows you to change lifting modules to suit your tonnage or height requirements.
- Select the collapsed height to fit your most frequent application and add jacking modules to suit your needs.
- Exclusive load control system provides positive, chatter-free control when lowering the load.
- Remote operation for maximum operator safety and control, motor or/an valve options.
- Easy to maneuver with large tires and small "footprint" make it easy to scoot into the tightest quarters.
- Adjustable, heavy-duty handle makes this jack easy to move, position under vehicles.
- Shielded and sheltered hydraulic lines for safer, longer, trouble-free service.



Jacks

JACK MODULE EXTENSION

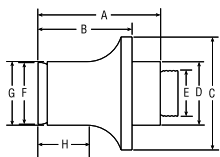

Order Number	Cap. (tons)	A	B	C	D	E	F	G	H	Prod. Wt. (lbs.)
		(in.)	(in.)	(in.)	(in.)	(in.)	(in.)	(in.)	(in.)	
58945	55	8.81	6.81	5.00	2.63	1 11/18-8UNC	2.50	2.63	3.63	21.00
58943	100	9.00	7.00	6.88	3.88	2 3/4-12UNC	3.75	3.88	3.75	40.00
58944	150	8.63	6.63	8.00	4.50	3 1/4-8UNC	4.38	4.50	3.50	50.00

CRIBBING BLOCK SETS - INCLUDES ONE JACK MODULE EXTENSION

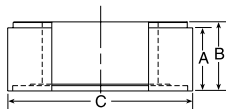

- Convert jack module into stable mechanical cribbing device.
- Increases total stack height up to 20.50".

Order Number	No. in Set	Cap. (ton)	A	B	C	Jack Module Ext. (in.)	Total Stack Height (in.)	Prod. Weight. (lbs.)
			(in.)	(in.)	(in.)			
CBS55	1	55	1.50	1.75	5.50	6.81	20.31	36.00
	4		3.00	3.25				
CBS100	1	100	1.50	1.75	7.38	7.00	20.50	68.00
	4		3.00	3.25				
CBS150	1	150	1.50	1.75	8.75	6.63	20.13	85.00
	4		3.00	3.25				
CBS200	1	200	1.50	1.75	10.00	6.63	20.13	105.00
	4		3.00	3.25				



Pump Module, include Remote Pendant

Pump	Motor Only	Motor & Valve
Air	PMA55	PMA55S
Electric	PME55	PME55S
Electric	PME355	PME355S
Air	PMA355	PMA355S



Jack Modules

Tonnage	Cylinder Stroke	Collapsed Height		
		26"	33"	45"
55	13.13	JM25	JM35	JM45
100	13.13	JM210	JM310	JM410
150	18.13	JM215 †	JM315	JM415
200	18.13	JM220 *	JM320	JM420
300	13.13	Contact Factory		

* Collapsed height; 28" and stroke 13.13"

† Stroke 13.13".

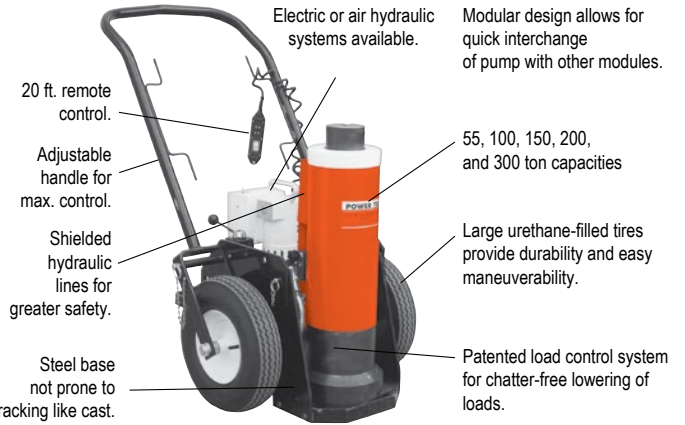

PUMP & CART MODULES

Pump and cart modules contain hydraulic pump, cart, remote control and all hoses and fittings required to connect to a jack module.

JACK MODULES

Jack modules easily separate from the pump and cart module.

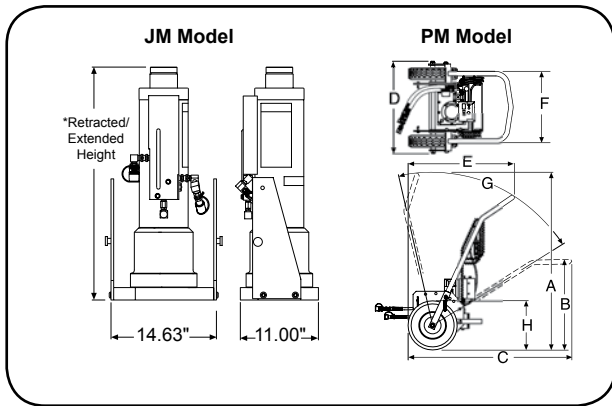

Jacks

Technical Dimensions

Model Series	A	B	C	D	E	F	G *	H
	(in.)	(in.)	(in.)	(in.)	(in.)	(in.)	(deg.)	(in.)
PMA	57.88	29.62	53.25	30.00	34.31	23.38	70°	16" Tire Dia.
PME								

* Total range with varying degree increments.

Ordering Information - Complete with Pump and Jack Modules, Fully Assembled

Order Number	Cap. (tons)	Retracted Height (in.)	Extended Height (in.)	Stroke (in.)	Pump Type	Power Required	Valve Type	Remote Control
JEM5526	55	26.00	39.13	13.13	Electric	25 amps	Manual	Motor Only
JAM10033	100	33.00	46.13	13.13	Air	50 CFM @ 80 ps	Manual	Motor Only
JAR10033	100	33.00	46.13	13.13	Air	50 CFM @ 80 psi	Air Pilot	Motor & Valve
JEM15026	150	26.00	39.13	13.13	Electric	25 amps	Manual	Motor Only
JAM15033	150	33.00	46.13	13.13	Air	50 CFM @ 80 psi	Manual	Motor Only

Model Shown:
IJ2211T

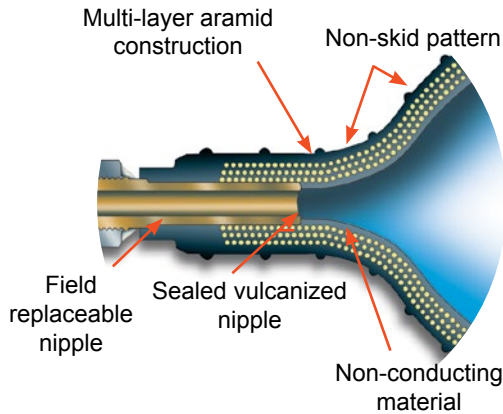

► The non-skid reinforced inflatable jack is perfect for many applications.



Features

LOW HEIGHT, HEAVY-DUTY INDUSTRIAL INFLATABLE AIR JACKS.

- Non-inflated jacks are less than 1" thick, making lifting tasks in small spaces seem routine.
- Constructed of non-conducting, high quality rubber material with multi-layer aramid fiber reinforcement.
- The top and bottom surface of the jack has a skid resistant, interlocking pattern to assist in alignment of two jacks being used together.
- Heavy attachment handles are provided on the two largest jacks for attachment of a rope or hook to help in positioning the jack.
- The jacks can be used at ambient temperatures of -4°F to +122°F (-20°C to + 50°C).
- The controller, shut-off and air hoses are all equipped with an industrial interchange style quick-disconnect air coupler. Female half coupler bodies have a locking collar to help the operator avoid accidentally disconnecting the jack while under load.
- Single jack controller with "dead man" control (part no. 350090) can be used individually, or in multiples to regulate the number of jacks desired.



Safety Hints

BE SAFE!

- INSPECT BEFORE AND AFTER EACH USE.
- REPLACE IF ANY SIGNS OF DEGRADATION OR WEAR THAT MAY AFFECT SAFETY OR PERFORMANCE.
- KEEP THE PRODUCT CLEAN.
- STORE PROPERLY.



Maximum Effective Lifting Area

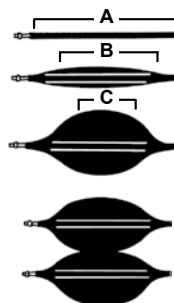

All lifting capacities mentioned in the charts are measured at the maximum effective lifting area (A). As the jack is inflated (B), this effective area decreases (C) due to the rounded shape of the jack. Lifting capacity also decreases (see performance chart).

Stack up to two jacks together to increase effective lifting height.

Performance Specifications

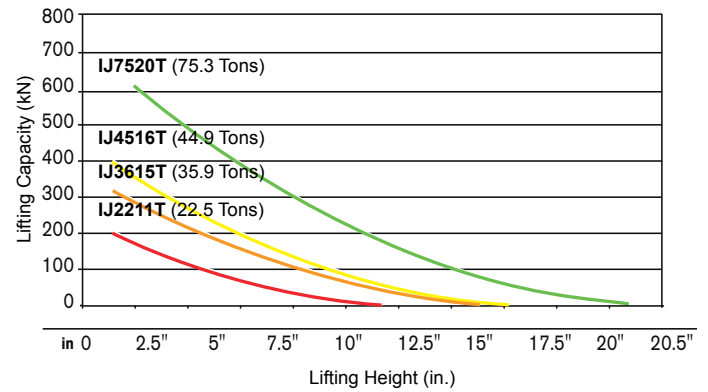
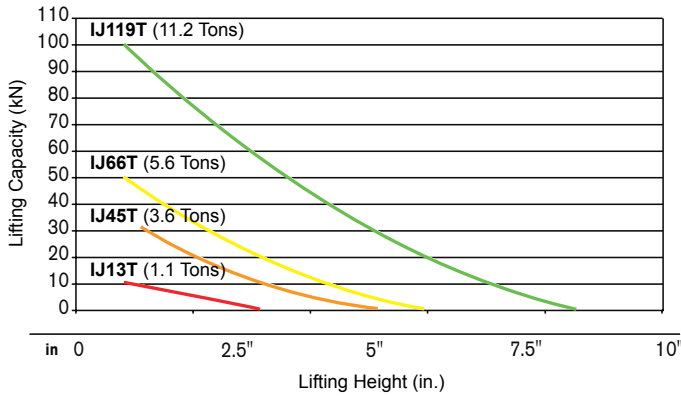

Typical Set-Up

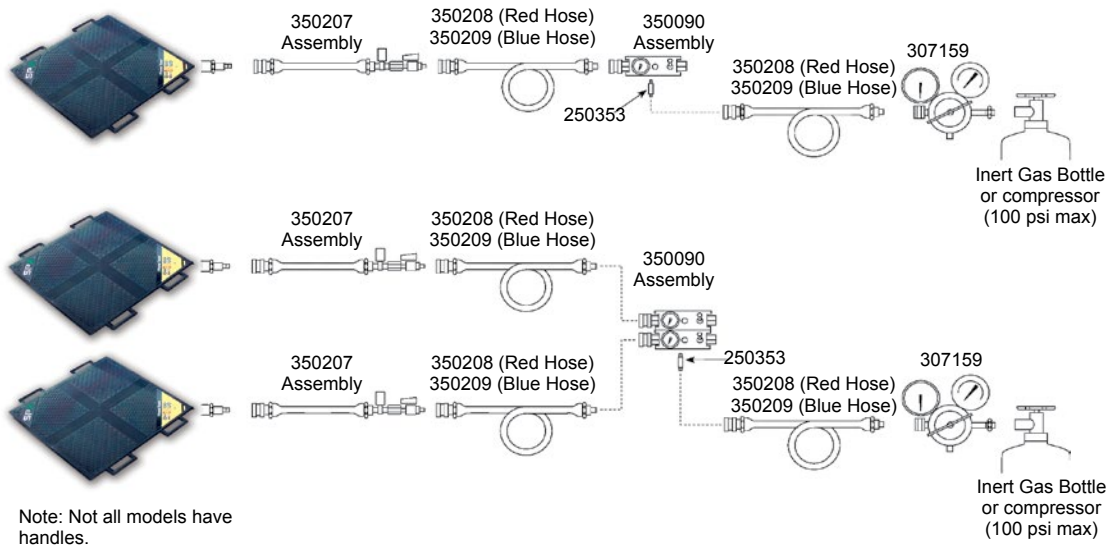

Ordering Information

Order Number	Lifting Cap. (lbs.)	Lifting Height (in.)	Air Volume (cu. ft.)	Water Volume (gal.)	Length (in.)	Width (in.)	Thickness (in.)	Prod. Wt. (lbs.)
IJ13T	2,248	3.1	0.12	0.18	6.00	6.00	0.87	1.30
IJ45T	7,194	5.1	0.57	.048	9.00	9.00	0.87	3.30
IJ66T	11,240	5.9	0.80	0.66	11.00	11.00	0.87	4.40
IJ119T	22,480	8.5	2.70	2.24	15.00	15.00	0.98	9.00
IJ2211T	44,960	11.4	6.67	5.55	20.00	20.00	0.98	15.50
IJ3615T	71,930	15.0	15.89	13.00	26.00	26.00	0.98	29.00
IJ4516T*	89,920	15.9	19.70	16.38	38.00	38.00	0.98	33.00
IJ7520T*	150,610	20.5	42.59	35.40	36.00	36.00	0.98	53.00

* Included molded carry handles.

PRESSURE REDUCING VALVE



Order No.	Description
307159	Pressure reducing valve. Allows use of bottled gases to operate jacks (works on CGA-580 Nitrogen/Argon/Helium bottles). Contains standard bottle fitting on inlet and 1/4" industrial interchange female outlet. Wt., 4 lbs.

AIR CONTROLLER - SINGLE JACK



Order No.	Description
350090	Air controller for single jack. Equipped with relief valve and pressure gauge. Wt., 1.9 lbs.

SHUT-OFF HOSE WITH SHUT-OFF VALVE AND PRESSURE RELIEF VALVE



Order No.	Description
350207	Shut-off hose with shut-off valve and pressure relief valve. Includes a female and male quick coupler. Wt., 0.7 lbs.

AIR HOSES



Order No.	Description
350208	Air hose. Red, 30' long., 3/8" I.D., includes 250341 female and 250342 male quick coupler. Wt., 6.0 lbs.
350209	Air hose. Blue, 30' long., 3/8" I.D., includes 250341 female and 250342 male quick coupler. Wt., 6.0 lbs.

FEMALE QUICK COUPLER



Order No.	Description
250343	Female quick coupler. 1/4" industrial interchange x 1/8" NPT female. Wt., 0.1 lb.

MALE QUICK COUPLER



Order No.	Description
250353	Male quick coupler. 1/4" industrial interchange x 1/8" NPT male. Wt., 0.1 lb.

FEMALE QUICK COUPLER



Order No.	Description
250682	Female quick coupler. 1/4" industrial interchange x 1/4" NPT male. Wt., 0.1 lb.

CONNECTOR 1/8" NPT MALE



Order No.	Description
15235	Connector 1/8" NPT male x 1/4" NPT female. Wt., 0.1 lb.

FEMALE QUICK COUPLER



Order No.	Description
250341	Female quick coupler. 1/4" industrial x 3/8" I.D. hose. Wt., 0.5 lb.

MALE QUICK COUPLER



Order No.	Description
250342	Male Quick coupler. 3/8" I.D. Hose. Wt., 0.1 lb.

Model Shown:
IM10E, IM10H



NOTE: Actual storage box may differ from photo.

Features

TURNKEY, EXTREMELY VERSATILE MECHANICS MAINTENANCE KIT FITS MANY APPLICATIONS.

- Matched hydraulic system components, adapters and hydraulic spreader, contained in a rugged carrying and storage case.
- Portable sets are ideal for pushing, pulling, lifting, straightening, or clamping at remote job sites.
- Cylinders in set are rated at 10 tons at 10,000 psi. Set components are designed for full rated capacity of cylinders.
- Set IM10H/IM10L includes hand operated pump. Set IM10E includes the Quarter Horse® electrically driven portable power unit.



Application Flexibility

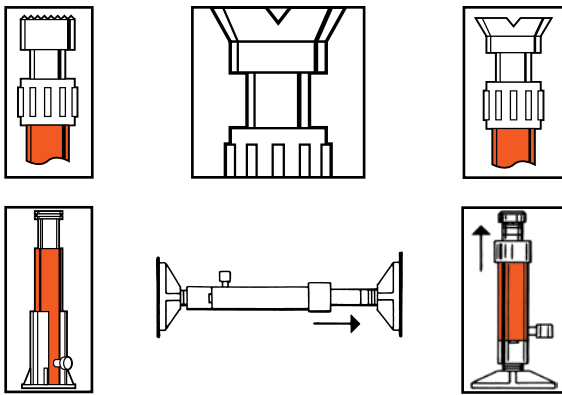

Ordering Information

Order No.	IM10E
CONTENTS OF SET	Items Included Below
Hydraulic spreader	HS2000
Hand pump (electric)	PE102
Hydraulic gauge (10,000 psi)	9041
Tee adapter	9670
Hose & coupler assembly	9754
90° V base	25395
Threaded coupler	25664
Serrated saddle	31772
Flat base	32325
Extension rod - 5" length	350897
Extension rod - 10" length	38909
Extension rod - 18" length	350898
Cylinder support base	420062
Cylinder, 10 ton, 6.13 stroke	C106CBT
Cylinder, 10 ton, 10.13 stroke	C1010CBT
Storage box	350722
Prod. Weight (lbs.)	106.00

Order No.	IM10H	IM10L
CONTENTS OF SET	Items Included Below	Items Included Below
Hydraulic spreader	HS2000	HS2000
Hand pump	P59	P59L
Hydraulic gauge (10,000 psi)	9041	9041
Tee adapter	9670	9670
Hose & coupler assembly	9754	9754
90° V base	25395	25395
Threaded coupler	25664	25664
Serrated saddle	31772	31772
Flat base	32325	32325
Extension rod - 5" length	350897	350897
Extension rod - 10" length	38909	32890
Extension rod - 18" length	350898	350898
Cylinder support base	420062	420062
Cylinder, 10 ton, 6.13 stroke	C106CBT	C106CBT
Storage box	350722	350722
Prod. Weight (lbs.)	89.00	81.00

Model Shown:
SK10T



Features

**VERSATILE 10 TON MAINTENANCE KIT
CONVENIENTLY PACKAGED IN A BOX.**

- 10 ton Start-Up Kit covers a range of lifting, shifting, and positioning needs
- Broad range of cylinder types and strokes to fit many applications
- Neatly packaged in a durable, molded storage case to securely house your equipment and is ready to use upon opening
- SK10TE kit is CE Compliant



Storage Case Dimensions



Plastic Molded Case, 31.5"(L) x 20.5"(H) x 11.5"(W).

Ordering Information

Order No		Kit Contents			
SK10T	SK10TE	Hand Pump	Usable Oil Cap. (in ³ .)	Volume Per Stroke Low / High Press. (in ³ .)	Weight (lbs.)
X	X	P19L	27	0.25 / 0.05	5.10
		Gauge	Type	Primary Units	Face Diameter (in.)
X		9040	analog	psi	2.50
		Hose	Length (ft.)	Burst Rating	I.D. (in.)
X		9754	6.00	2:1	1/4
		Cylinders	Capacity* Short Tons	Stroke (in.)	Collapsed Height (in.)
X	X	C106C	10	6.00	9.75
X	X	RSS101	10	1.00	3.50
X	X	RH123	12	3.00	7.25
X	X	RLS100	10	0.44	1.75
		Spreader	Min. Clearance (in.)	Max Spread (in.)	Weight (lbs.)
X	X	HS2000	0.56	4.00	4.80
		Case	Material	L x H x W (in.)	Weight w/o Product (lbs.)
X	X	2008632	Heavy-Duty Plastic	31.5 x 20.5 x 11.5	12.70

* Values shown in short tons (2,000 lb). To convert to long tons, multiply by 0.893. To convert to metric tons, multiply by 0.907.

Model Shown:
SK25T



NOTE: Storage cases are not included with the 25 ton startup kits, they must be ordered separately.

Features

THE RIGHT CHOICE FOR THOSE HIGHER TON MAINTENANCE KIT NEEDS.

- 25 Ton Start-Up Kit covers a range of lifting, shifting, and positioning needs
- Broad range of cylinder types and strokes to fit many applications
- SK25TE kit is CE Compliant



Optional 25 Ton Storage Cases

MB5

308435OR9

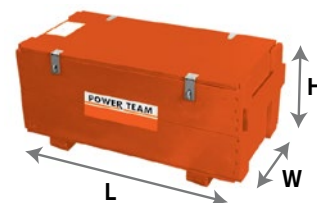
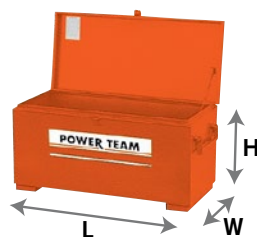

Order No.	Description
MB5	Metal Box Construction, 32" (L) x 19" (W) x 14" (H)
308435OR9	Wooden Box Construction, 36" (L) x 17.5" (W) x 14" (H)

Ordering Information

Order No		Kit Contents			
SK25T	SK25TE	Hand Pump	Usable Oil Cap. (in ³ .)	Volume Per Stroke Low / High Press. (in ³ .)	Weight (lbs.)
X	X	P59L	66	0.72 / 0.15	8.90
		Gauge	Type	Primary Units	Face Diameter (in.)
X		9040	analog	psi	2.50
		Hose	Length (ft.)	Burst Rating	I.D. (in.)
X		9754	6.00	2:1	1/4
		Cylinders	Capacity* Short Tons	Stroke (in.)	Collapsed Height (in.)
X	X	C256C	25	6.00	10.75
X	X	RSS302	30	2.00	4.63
X	X	RH302	30	2.00	6.25
X	X	RLS300	30	0.50	2.31
		Spreader	Min. Clearance (in.)	Max Spread (in.)	Weight (lbs.)
X	X	HS2000	0.56	4.00	4.80

* Values shown in short tons (2,000 lb). To convert to long tons, multiply by 0.893. To convert to metric tons, multiply by 0.907.

Model Shown:
SJ2010, SJ3010



>Features

ONE OF THE MOST DURABLE MONO-STRAND JACKS IN THE INDUSTRY.

- Ideally suited for work on slab-on-grade where dirt, heat and high volume use take their toll.
- Available in single or double-acting models.
- Standard single-acting units have a 10" stroke.
- Standard double-acting units have an 8.5" stroke.
- Service repair is simple and components are long lasting and easily replaced.
- 3" detachable seater nose assembly easily replaced with optional 6" nose assembly.
- The jack of choice for high-rise and elevated work, thanks to fast return time and light weight.
- All hydraulic fluid controls are internal for more efficient and safer operation during tensioning and retraction.



Optional Dead-end Seater

Dead-end seaters for production work and field work available on special order. (Part #400120)

▶ Multi-strand post-tensioning application.



▶ Technical Dimensions

Order No.	A	B	C	Wt. (lbs.)
	(in.)	(in.)	(in.)	
SJ2010	21.00	9.00	6.50	55.00
SJ2010P	22.00	10.20	7.00	76.00
SJ3010	22.00	10.20	7.00	76.00
SJ3010P	22.00	13.20	7.00	76.00
SJ2010DA	18.50	7.50	6.50	42.00
SJ3010DA	18.50	8.50	6.50	52.00

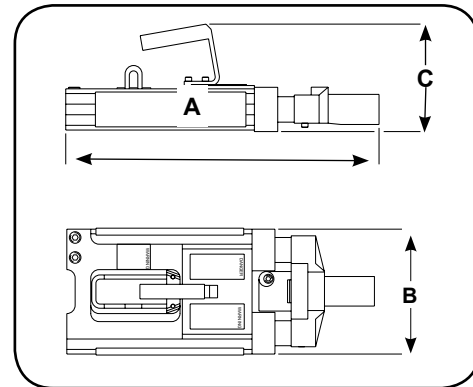

▶ Ordering Information

Order Number	Cap. (tons)	Stroke (in.)	Oil Cap. (cu. in.)	Strand Dia. (in.)	Seater Type (in.)	Int. Press. at Cap. (in.)	Tons at 10,000 psi	Description	Recommended Pumps for this Stressing Jack	Prod. Wt. (lbs.)
SJ2010	20	10.00	45.2	0.375 - 0.50	Spring	8,948	22.4	Post-tension jack with spring seater, 0.50" strand.	PE554P/PE604T	55.00
SJ2010P	20	10.00	45.2	0.375 - 0.50	Power	8,948	22.4	Post-tension jack with power seater, 0.50" strand.	PE554PT/PE604PT	55.00
SJ2010DA	20	8.50	53.0	0.375 - 0.50	Power	7,575	26.4	Double-acting post-tension jack with power seater, 0.50" strand.	PE554PT/PE604PT	42.00
SJ3010	30	10.00	63.6	0.375 - 0.60	Spring	9,549	31.4	Post-tension jack with spring seater, 0.60" strand.	PE554P/PE604T	76.00
SJ3010P	30	10.00	63.6	0.375 - 0.60	Power	9,549	31.4	Post-tension jack with power seater, 0.60" strand.	PE554PT/PE604PT	76.00
SJ3010DA	30	8.50	67.6	0.375 - 0.60	Power	7,554	39.7	Double-acting post-tension jack with power seater, 0.60" strand.	PE554PT/PE604PT	52.00

Jacks

STRESSING JACK ACCESSORIES AND HOSES

Used with Stressing Jack	3" Nose Piece #	3" Wedge Seater #	6" Nose Piece	6" Wedge Seater #	3/8" Dia. Gripper Set #	7/16" Dia. Gripper Set #	1/2" Gripper Set #	19/32" Gripper Set #	Replacement Gripper Handle #	Gripper Retainer Plate # (2 used)
SJ2010	252564	252562	252759	252763	252568	252761	252567	NA	252570	252565
SJ2010P	252564	252562	252759	252763	252568	252761	252567	NA	252570	252565
SJ2010DA	252543	252542	252760	252764	252650	252762	252555	NA	252556	252544
SJ3010	252564	252562	252759	252763	252568	252761	252567	252569	252570	252565
SJ3010P	252564	252562	252759	252763	252568	252761	252567	252569	252570	252565
SJ3010DA	253363	253361	253364	253362	253390	NA	253391	253365	252556	252544

HYDRAULIC & MECHANICAL TOOLS



SELECT FROM A WIDE RANGE OF HYDRAULIC & MECHANICAL TOOLS TO COMPLETE YOUR SYSTEM REQUIREMENTS

- Full range of torque wrenches, low clearance in-line drives and pumps for your bolting applications.
- Specialty tools include nut splitters, spreaders, bead breakers and pipe flange tools.
- Hydraulic clamps for those unique applications requiring higher forces
- Hydraulic testers and accessories to monitor hydraulic circuits
- Wide selection of mechanical tools, such as pliers, pry bars, O-ring picks, thread chasers and more.



	Section / Series	Page Description	Page(s)
	TWHC, TWSD, TWLC, TWSL	High Cycle Torque Wrench, Square Drive Torque Wrench, Low Clearance Torque Wrench, SlimLine Torque Wrench	187-190 191-194 195-199 201-202
	X1	X1E1 - Electric Torque Wrench Pump, X1A1 - Air Torque Wrench Pump	203 204
	PE30 & PE55	Electric Hydraulic Torque Wrench Pump	205-206
	PE55 TWP	Electric Hydraulic Torque Wrench Pump	206
	RWP55	Air Hydraulic Torque Wrench Pump	207
	HNS	Hydraulic Nut Splitter	208
	FLS	Hydraulic Flange Spreader	209-210
	HFS	Pipe Flange, Hydraulic Spreader	211
	HS	Hydraulic Spreaders	212
	CC	Hydraulic C-Clamps & Accessories	213
	BB	Bead Breaker, Tire Removing Tool	214
	HP35	Hydraulic Punches and Accessories	215-216
	HT	Hydraulic Testers and Accessories	217-219
	PLIERS	Retaining Ring Pliers (Internal & External)	220
	HAND TOOLS	Wrenches, Pry Bars, Spanners & Jimmy Bars	221
	SERVICE TOOLS	Pipe Sealant, O-Ring Seal Picks, Thread Chaser, and Magnetic Pick-Up	222

Model Shown:
TWHC3



>Features

QUALITY MEANS LOWER COST OF OWNERSHIP

- Designed for high cycle life (2-3x more than existing technology)
- Increased reliability provided by simple drive assembly means less downtime
- Corrosion resistant material for use in harsh environments

ENHANCED USABILITY:

- Compact nose radius allows the tool to fit in tighter, hard-to-reach spaces
- Low weight, high strength design
- Fast operation, long stroke and optimum flow
- Multi-direction high flow swivel manifold
- Push-button square drive reversal and reaction arm positioning for all models except TWHC50.

DESIGNED WITH SAFETY IN MIND:

- Fully-enclosed drive mechanism for operator safety
- Swivel manifold internal relief valve prevents retract side over-pressurization
- Fine tooth pawl prevents tool 'lock-on'

▶ The TWS50 is the perfect choice in this power generation application.



HANDLES SOLD SEPARATELY



The tool's designed long-stroke mechanism imparts a minimum 30 degree nut rotation per stroke while maintaining a tight and compact nose radius. This is a clear advantage over the short stroke and back-up pawl mechanisms of light alloy competitive models. Fewer parts and reduced torsion in operation equals reduced wear, maintenance and associated costs.

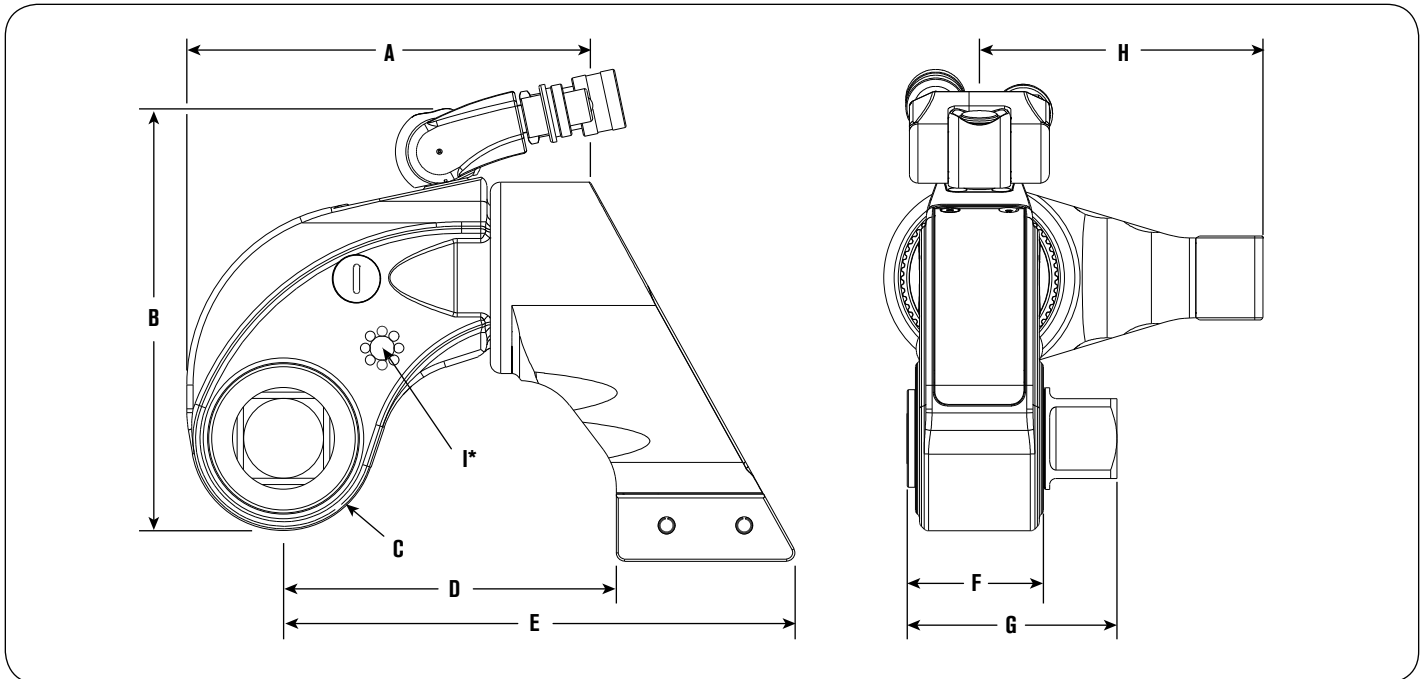

* Dimension I shows thread size (on both sides of the tool) for safety handle or lifting point. TWHC50 model available with lifting points only.

Technical Dimensions

Tool Model	Min Torque (ft. lbs.)	Max Torque (ft. lbs.)	Square Drive (in.)	A	B	C	D	E	F	G	H	I	Prod. Wt. (lbs.)
				(in.)	(in.)	(in.)	(in.)	(in.)	(in.)	(in.)	(in.)	(in.)	
TWHC1	170	1,413	0.75	5.20	5.71	1.10	4.39	6.69	1.56	2.67	3.39	M6 x 1.0	6.2
TWHC3	376	3,136	1.00	6.50	6.83	1.44	5.10	7.78	2.09	3.30	4.14	M6 x 1.0	11.7
TWHC6	726	6,050	150	7.56	7.94	1.73	6.24	9.59	2.40	3.93	5.32	M8 x 1.25	19.4
TWHC50	6,360	53,000	2.50	15.93	14.04	3.46	10.49	17.58	4.53	7.57	10.16	M12 x 1.75	152

Tools

Ordering Information

Order No.	Description
TWHC1	Wrench
TWHC3	Wrench
TWHC6	Wrench
TWHC50	Wrench

Order No.	Description
TWHC1H	Wrench with Handle
TWHC3H	Wrench with Handle
TWHC6H	Wrench with Handle

Order No.	Description
DFTAS000001	Handle for TWHC1
DFTAS000001	Handle for TWHC3
DFTAS000002	Handle for TWHC6

TWHC EXTENDED REACTION ARM TWHC-ERA



Features

- Long reach version of TWHC standard reaction arm
- 3 standard sizes per model (0.98 in./1.97 in./2.95 in.), specials upon request
- Replaces standard reaction arm via quick release locking pin
- Steel alloy construction
- 360° rotation
- Available for full range of tool sizes

Ordering Information

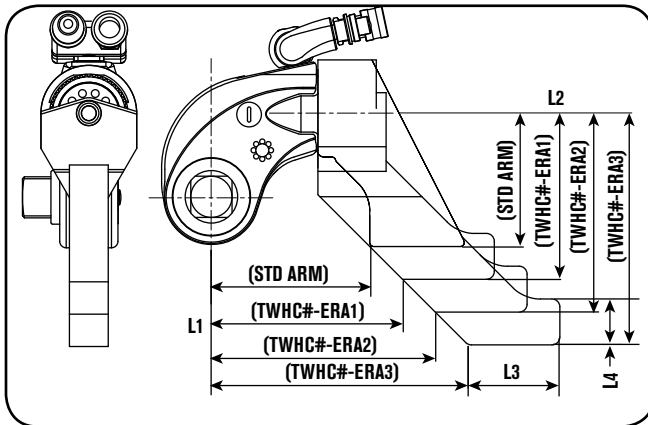

Tool Ref	Order No.	L1 (in.)	L2 (in.)	L3 (in.)	L4 (in.)
STD ARM		4.41	3.39	—	—
TWHC1	TWHC1-ERA1	5.39	4.37	2.36	1.18
	TWHC1-ERA2	6.38	5.35		
	TWHC1-ERA3	7.36	6.34		
STD ARM		5.12	4.13	—	—
TWHC3	TWHC3-ERA1	6.10	5.12	2.76	1.38
	TWHC3-ERA2	7.09	6.10		
	TWHC3-ERA3	8.07	7.09		
STD ARM		6.23	5.35	—	—
TWHC6	TWHC6-ERA1	7.24	6.34	3.74	1.57
	TWHC6-ERA2	8.23	7.32		
	TWHC6-ERA3	9.21	8.31		

TW HANDLE

Tools



Features

- Robust steel construction with ribbed polymer grip
- Multi-position on tool for balanced handling
- Cap-screw locking with positive 'docking'
- Is suitable for all wrench models (TWHC, TWSD, TWLC). However, for larger sizes (TWSD25/TWLC 30/TWHC50) we recommend the use of eye-bolt lifting.

Ordering Information

Order No.	Description	Tool Ref
DFTAS000001	Wrench Handle	TWSD1
		TWSD3
		TWHC1
		TWHC3
		TWLC2

Order No.	Description	Tool Ref
DFTAS000002	Wrench Handle	TWSD6
		TWSD11
		TWHC6
		TWLC4
		TWLC8
		TWLC15

TWHC REACTION PAD TWHC-RP



Features

- In-Line Reaction Pad for TWHC wrenches used as simple pad, or modified platform for specific application (Machine-able/Weld-able platform)
- Replaces standard reaction arm via quick release locking pin
- Steel alloy construction
- 360° rotation
- Available for full range of tool sizes

Ordering Information

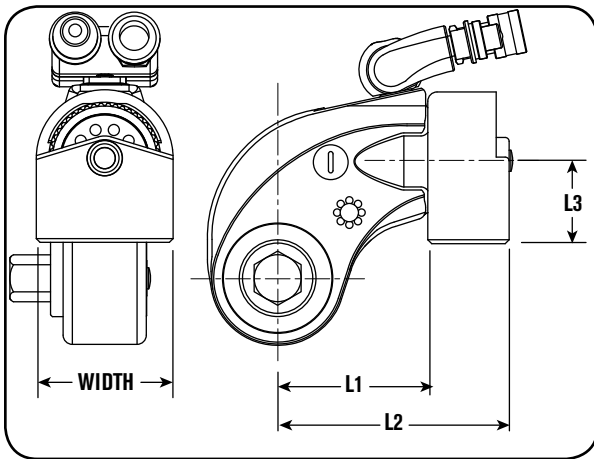

Tool Ref	Order No.	L1 (in.)	L2 (in.)	L3 (in.)	Width (in.)
TWHC1	TWHC1-RP	2.835	4.567	1.93	2.52
TWHC3	TWHC3-RP	3.39	5.43	2.17	2.99
TWHC6	TWHC6-RP	3.90	6.38	2.44	3.50

TWHC LONG REACTION ARM TWHC-LRA



Features

- Tubular extension arm for TWHC wrenches for in-line reaction outside wrench profile
- Replaces standard reaction arm via quick release pin locking
- Steel/light alloy construction (reaction flat machined on tube end)
- Can be cut down to suit specific length
- Available for full range of tool sizes

Ordering Information

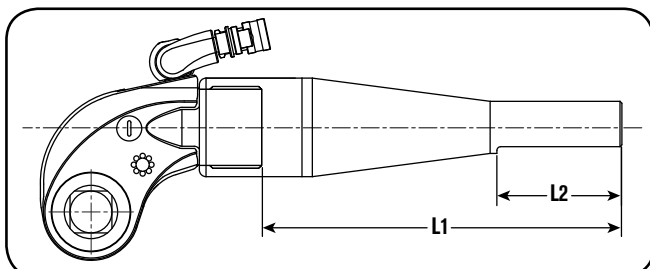

Tool Ref	Order No.	L1 (in.)	L2 (in.)
TWHC1	TWHC1-LRA	19.72	6.00
TWHC3	TWHC3-LRA		
TWHC6	TWHC6-LRA		

Model Shown:
TWSD11



Features

HYDRAULIC SQUARE DRIVE TORQUE WRENCHES

- Corrosion resistant finish, low weight, high strength steel body construction design with superior torsional strength.
- Fast operation cycle, fine tooth ratchet, with floating piston design.
- Multi-axis high flow swivel manifold with internal relief valve prevents retract side over-pressurization
- Push button reversal of square drive
- 360° reaction arm, with push to lock reaction arm.
- Simple design, fully enclosed drive mechanism, provides accurate torque output

NOTE: Standard Reaction Arm included for all models

▶ The TWSD11 is the perfect choice with a large reaction surface to eliminate damage to the gears during the tightening process.

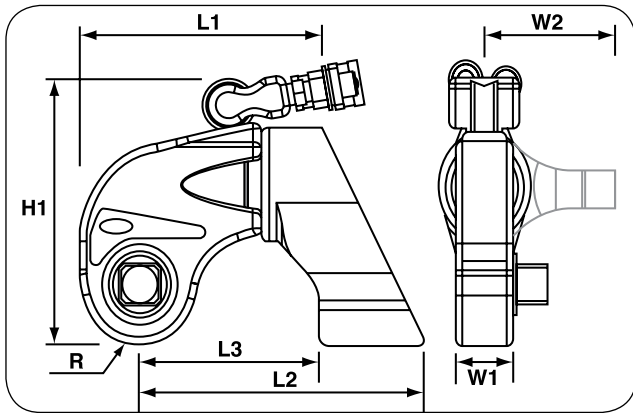

Tools

Technical Dimensions

Tool Model	L1	L2	L3	H1	R	W1	W2	Square Drive	Max. Torque	Tool Wt.
	(in.)	(in.)	(in.)	(in.)	(in.)	(in.)	(in.)	(in.)	(ft. lbs.)	(lbs.)
TWSD1	5.47	6.69	4.41	5.71	1.10	1.30	3.39	0.75	1,390	5.07
TWSD11	9.21	11.50	7.01	9.49	2.20	2.40	6.50	1.50	10,940	28.88
TWSD25	12.01	14.80	9.09	12.40	2.80	2.99	7.87	2.50	24,700	65.04

Ordering Information

Order No.	Description
TWSD1	Wrench - 1,300 lb-ft
TWSD11	Wrench - 10,940 lb-ft
TWSD25	Wrench - 24,500 lb-ft

Order No.	Description
DFTAS000001	Wrench Handle Size 1 Tool Ref. TWSD1 and TWSD3
DFTAS000002	Wrench Handle Size 2 Tool Ref. TWSD06 and TWSD11

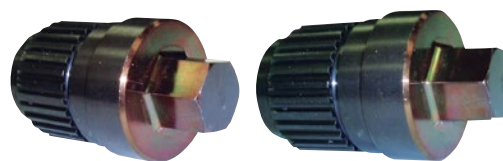

Ordering Information

SQUARE DRIVE - ADAPTERS & SOCKETS

Torque Wrench	Hexagon Drive Size AF (in.)	Order No.		Torque Wrench	Hexagon Drive Size AF (in.)	Order No.	
		TWSD	TWHC			TWSD	TWHC
(TWSD1) (TWHC1)	0.63	TWD1-063	TWHCHD01-063	(TWSD6) (TWHC6)	1.25	TWD6-125	TWHCHD06-125
	0.75	TWD1-075	TWHCHD01-075		1.38	TWD6-138	TWHCHD06-138
	0.88	TWD1-088	TWHCHD01-088		1.50	TWD6-150	TWHCHD06-150
	1.00	TWD1-100	TWHCHD01-100		1.63	TWD6-163	TWHCHD06-163
(TWSD3) (TWHC3)	0.63	TWD3-063	TWHCHD03-063	(TWSD11)	1.13	TWD11-113	-
	0.75	TWD3-075	TWHCHD03-075		1.25	TWD11-125	-
	0.88	TWD3-088	TWHCHD03-088		1.38	TWD11-138	-
	1.00	TWD3-100	TWHCHD03-100		1.50	TWD11-150	-
	1.13	TWD3-113	TWHCHD03-113		1.63	TWD11-163	-
	1.25	TWD3-125	TWHCHD03-125		1.75	TWD11-175	-
	1.38	TWD3-138	TWHCHD03-138	(TWSD25)	1.50	TWD25-150	-
	1.50	TWD3-150	TWHCHD03-150		1.63	TWD25-163	-
1.63	TWD3-163	TWHCHD03-163	1.75		TWD25-175	-	
0.88	TWD6-063	TWHCHD06-063	1.88		TWD25-188	-	
(TWSD6) (TWHC6)	0.75	TWD6-075	TWHCHD06-075	2.00	TWD25-200	-	
	0.88	TWD6-088	TWHCHD06-088	2.25	TWD25-225	-	
	1.00	TWD6-100	TWHCHD06-100	2.50	TWD25-250	-	
	1.13	TWD6-113	TWHCHD06-113	2.75	TWD25-275	-	



Ordering Information

SQUARE DRIVE - IMPACT SOCKETS

Socket Size (in.)	0.75" Drive	1.00" Drive	1.50" Drive	2.50" Drive	Socket Size (in.)	0.75" Drive	1.00" Drive	1.50" Drive	2.50" Drive
	Part No.	Part No.	Part No.	Part No.		Part No.	Part No.	Part No.	Part No.
0.88	TWSIA088	TWSIB088	—	—	3.13	—	TWSIB313	TWSIC313	TWSIF313
1.06	TWSIA106	TWSIB106	—	—	3.38	—	TWSIB338	TWSIC338	TWSIF338
1.25	TWSIA125	TWSIB125	—	—	3.50	—	TWSIB350	TWSIC350	TWSIF350
1.38	TWSIA138	TWSIB138	—	—	3.75	—	TWSIB375	TWSIC375	TWSIF375
1.44	TWSIA144	TWSIB144	—	—	3.88	—	TWSIB388	—	TWSIF388
1.63	TWSIA163	TWSIB163	TWSIC163	—	4.13	—	TWSIB413	TWSIC413	TWSIF413
1.81	TWSIA181	TWSIB181	-	—	4.25	—	TWSIB425	TWSIC425	TWSIF425
2.00	TWSIA200	TWSIB200	TWSIC200	—	4.63	—	—	TWSIC463	TWSIF463
2.19	TWSIA219	TWSIB219	TWSIC219	—	5.00	—	—	—	TWSIF500
2.38	TWSIA238	TWSIB238	TWSIC238	—	5.38	—	—	—	TWSIF538
2.56	—	TWSIB256	TWSIC256	—	5.75	—	—	—	TWSIF575
2.75	—	TWSIB275	TWSIC275	—	6.13	—	—	—	TWSIF613
2.94	—	TWSIB294	TWSIC294	—					

Note: For Long Reach (Extended Length) sockets add "LR" to the end of the part number. For 12 point (bi-hex) sockets, add "BH" to the end of the part number.

TWSD EXTENDED REACTION ARM TWSD-ERA



Features

- Long reach version of TWSD standard reaction arm
- 3 standard sizes per model (0.98 in./1.97 in./2.95 in.), specials upon request
- Replaces standard reaction arm via quick release locking pin
- Steel alloy construction
- 360° rotation
- Available for full range of tool sizes

Ordering Information

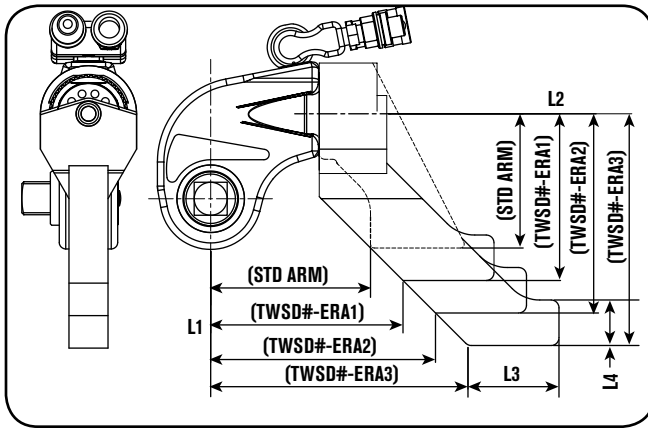

Tool Ref	Order No.	L1 (in.)	L2 (in.)	L3 (in.)	L4 (in.)
STD ARM		4.41	3.39		
TWSD1	TWSD1-ERA1	5.39	4.37	2.36	1.18
	TWSD1-ERA2	6.38	5.35		
	TWSD1-ERA3	7.36	6.34		
STD ARM		4.88	4.13		
TWSD3	TWSD3-ERA1	5.87	5.12	2.76	1.38
	TWSD3-ERA2	6.85	6.10		
	TWSD3-ERA3	7.83	7.09		
STD ARM		5.59	5.35		
TWSD6	TWSD6-ERA1	6.57	6.34	3.74	1.57
	TWSD6-ERA2	7.56	7.32		
	TWSD6-ERA3	8.54	8.31		
STD ARM		7.05	6.5		
TWSD11	TWSD11-ERA1	8.03	7.48	4.33	1.57
	TWSD11-ERA2	9.02	8.46		
	TWSD11-ERA3	10	9.45		
STD ARM		9.09	7.87		
TWSD25	TWSD25-ERA1	10.08	8.86	5.71	1.97
	TWSD25-ERA2	11.06	9.84		
	TWSD25-ERA3	12.05	10.83		

TW HANDLE

Tools



Features

- Robust steel construction with ribbed polymer grip
- Multi-position on tool for balanced handling
- Cap-screw locking with positive 'docking'
- Is suitable for all wrench models (TWHC, TWSD, TWLC). However, for larger sizes (TWSD25/TWLC30/TWHC50) we recommend the use of eye-bolt lifting.

Ordering Information

Order No.	Description	Tool Ref
DFTAS000001	Wrench Handle	TWSD1
		TWSD3
		TWHC1
		TWHC3
		TWLC2

Order No.	Description	Tool Ref
DFTAS000002	Wrench Handle	TWSD6
		TWSD11
		TWHC6
		TWLC4
		TWLC8
TWLC15		

TWSD REACTION PAD TWSD-RP



Features

- Wrench In-Line Reaction Pad for TWSD wrenches used as simple pad, or modified platform, for specific application (Machine-able/Weld-able platform)
- Replaces standard reaction arm via quick release locking pin
- Steel alloy construction
- 360° rotation
- Available for full range of tool sizes

Ordering Information

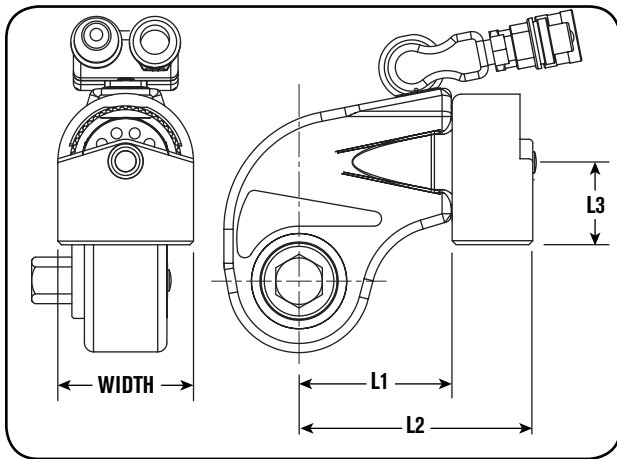

Tool Ref	Order No.	L1 (in.)	L2 (in.)	L3 (in.)	Width (in.)
TWSD1	TWSD1-RP	2.835	4.567	1.713	2.480
TWSD3	TWSD3-RP	3.307	5.354	1.890	2.913
TWSD6	TWSD6-RP	3.681	6.122	2.244	3.543
TWSD11	TWSD11-RP	4.311	7.264	2.579	4.133
TWSD25	TWSD25-RP	5.374	9.587	3.484	5.630

TWSD LONG REACTION ARM TWSD-LRA



Features

- Tubular extension arm for TWSD wrenches for in-line reaction outside wrench profile
- Replaces standard reaction arm via quick release locking pin
- Steel/light alloy construction (reaction flat machined on tube end)
- Can be cut down to suit specific length
- Available for full range of tool sizes

Tools

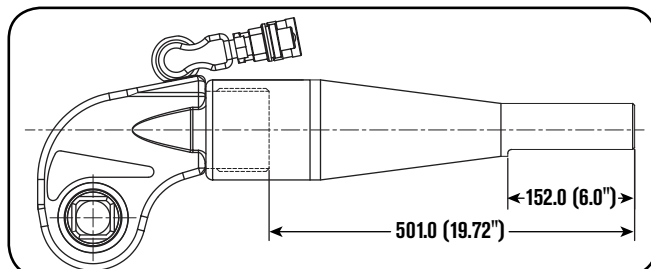

Ordering Information

Tool Ref	Order No.	L1 (in.)	L2 (in.)
TWSD1	TWSD1-LRA	19.72	6.00
TWSD3	TWSD3-LRA		
TWSD6	TWSD6-LRA		
TWSD11	TWSD11-LRA		
TWSD25	TWSD25-LRA		

Model Shown:
TWLC Body



* Links sold separately.
Tool is not shipped with link.

>Features

THE CLEARANCE TOOL FEATURES A LONG NECK, SHORT HEIGHT, AND SMALL NOSE RADIUS FOR INACCESSIBLE BOLTING AREAS FOUND IN INDUSTRY.

- Corrosion resistant finish, low weight, high strength steel body construction design with superior torsional strength.
- Fine tooth ratchet with floating piston design with small nose radius, allows for a fast operation cycle.
- Link pin does not fall out.
- Multi-axis high flow swivel manifold with internal relief valve prevents retract side over-pressurization
- “Hardened” steel reaction pad on TWLC8, 15 & 30
- Simple design, auto-connect drive piston quick interchangeable heads, no tools necessary, consistent torque output
- Replaceable reaction pad on larger models
- Power Team PowerThon™ Limited Lifetime Warranty

Tools

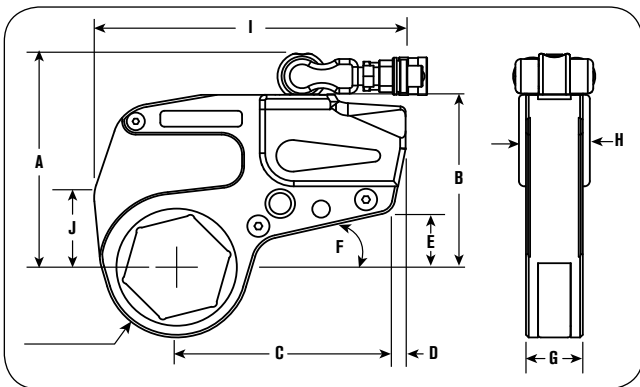

▶ Technical Dimensions

Body Order No.	A (in.)	B (in.)	C (in.)	D (in.)	E (in.)	F (deg.)	G (in.)	H (in.)
TWLC2	5.4	4.1	5.0	0.3	1.4	13	1.3	1.7
TWLC4	6.4	5.1	6.3	0.4	1.7	13	1.7	2.0
TWLC8	7.7	6.2	7.0	1.0	1.6	14	2.1	2.6
TWLC15	8.8	7.3	7.9	1.1	1.7	14	2.5	3.0
TWLC30	10.9	9.4	10.5	1.0	2.4	15	3.2	3.7

Torque Wrench Hoses - Non-Conductive Dual Line

Order No.	Hose Length (ft.)	Hose I.D. (in.)
TWH15	15	1/4"
TWH20	20	1/4"
TWH30	50	1/4"

▶ Ordering Information

Tool Model	Hex Range (in.)	Min. Torque (ft. lbs.)	Max. Torque (ft. lbs.)	Weight (Body Only) (lbs.)
TWLC2	1.25 - 2.38	189	1,575	2.2
TWLC4	1.50 - 3.13	477	3,975	4.4
TWLC8	2.38 - 3.88	954	7,950	7.7
TWLC15	2.56 - 4.63	1,782	14,850	15.4
TWLC30	3.13 - 6.13	3,456	28,800	31.9



Special sizes available upon request.

LOW CLEARANCE - REDUCERS								
Body	Link	Nut A/F	Reducer	Reducer	Reducer	Reducer	Reducer	Reducer
Order No.	Part No.	(in.)	(in.)	Part No.	(in.)	Part No.	(in.)	Part No.
TWLC2	TWL2-032	1.25	—	—	—	—	—	—
	TWL2-036	1.44	—	—	—	—	—	—
	TWL2-041	1.63	1.63 - 1.44	TWR2-041036	1.63 - 1.25	TWR2-041032	—	—
	TWL2-046	1.81	1.81 - 1.63	TWR2-046041	1.81 - 1.44	TWR2-046036	1.81 - 1.25	TWR-046032
	TWL2-050	2.00	2.00 - 1.81	TWR2-050046	2.00 - 1.63	TWR2-050041	2.00 - 1.44	TWR2-050036
	TWL2-055	2.19	2.19 - 2.00	TWR2-055050	2.19 - 1.81	TWR2-055046	2.19 - 1.63	TWR2-055041
TWLC4	TWL2-060	2.38	2.38 - 2.19	TWR2-060055	2.38 - 2.00	TWR2-060050	2.38 - 1.81	TWR2-060046
	TWL4-041	1.63	1.63 - 1.44	TWR4-041036	1.63 - 1.25	TWR4-041032	—	—
	TWL4-046	1.81	1.81 - 1.63	TWR4-046041	1.81 - 1.44	TWR4-046036	1.81 - 1.25	TWR4-046032
	TWL4-050	2.00	2.00 - 1.81	TWR4-050046	2.00 - 1.63	TWR4-050041	2.00 - 1.44	TWR4-050036
	TWL4-055	2.19	2.19 - 2.00	TWR4-055050	2.19 - 1.81	TWR4-055046	2.19 - 1.63	TWR4-055041
	TWL4-060	2.38	2.38 - 2.19	TWR4-060055	2.38 - 2.00	TWR4-060050	2.38 - 1.81	TWR4-060046
	TWL4-065	2.56	2.56 - 2.38	TWR4-065060	2.56 - 2.19	TWR4-065055	2.56 - 2.00	TWR4-065050
	TWL4-070	2.75	2.75 - 2.56	TWR4-070065	2.75 - 2.38	TWR4-070060	2.75 - 2.19	TWR4-070055
TWLC8	TWL4-075	2.94	2.94 - 2.75	TWR4-075070	2.94 - 2.56	TWR4-075065	2.94 - 2.38	TWR4-075060
	TWL4-080	3.13	3.13 - 2.94	TWR4-080075	3.13 - 2.75	TWR4-080070	3.13 - 2.56	TWR4-080065
	TWL8-060	2.38	2.38 - 2.19	TWR8-060055	2.38 - 2.00	TWR8-060050	2.38 - 1.81	TWR8-060046
	TWL8-065	2.56	2.56 - 2.38	TWR8-065060	2.56 - 2.19	TWR8-065055	2.56 - 2.00	TWR8-065050
	TWL8-070	2.75	2.75 - 2.56	TWR8-070065	2.75 - 2.38	TWR8-070060	2.75 - 2.19	TWR8-070055
	TWL8-075	2.94	2.94 - 2.75	TWR8-075070	2.94 - 2.56	TWR8-075065	2.94 - 2.38	TWR8-075060
	TWL8-080	3.13	3.13 - 2.94	TWR8-080075	3.13 - 2.75	TWR8-080070	3.13 - 2.56	TWR8-080065
	TWL8-085	3.38	3.38 - 3.13	TWR8-085080	3.38 - 2.94	TWR8-085075	3.38 - 2.75	TWR8-085070
TWLC15	TWL8-090	3.50	3.50 - 3.38	TWR8-090085	3.50 - 3.13	TWR8-090080	3.50 - 2.94	TWR8-090075
	TWL8-095	3.75	3.75 - 3.50	TWR8-095090	3.75 - 3.38	TWR8-095085	3.75 - 3.13	TWR8-095080
	TWL8-100	3.88	3.88 - 3.75	TWR8-100095	3.88 - 3.50	TWR8-100090	3.88 - 3.38	TWR8-100085
	TWL15-070	2.75	2.75 - 2.56	TWR15-070065	2.75 - 2.38	TWR15-070060	2.75 - 2.19	TWR15-070055
	TWL15-075	2.94	2.94 - 2.75	TWR15-075070	2.94 - 2.56	TWR15-075065	2.94 - 2.38	TWR15-075060
	TWL15-080	3.13	3.13 - 2.94	TWR15-080075	3.13 - 2.75	TWR15-080070	3.13 - 2.56	TWR15-080065
	TWL15-085	3.38	3.38 - 3.13	TWR15-085080	3.38 - 2.94	TWR15-085075	3.38 - 2.75	TWR15-085070
	TWL15-090	3.50	3.50 - 3.38	TWR15-090085	3.50 - 3.13	TWR15-090080	3.50 - 2.94	TWR15-090075
	TWL15-095	3.75	3.75 - 3.50	TWR15-095090	3.75 - 3.38	TWR15-095085	3.75 - 3.13	TWR15-095080
	TWL15-100	3.88	3.88 - 3.75	TWR15-100095	3.88 - 3.50	TWR15-100090	3.88 - 3.38	TWR15-100085
TWLC30	TWL15-105	—	—	—	—	—	—	—
	TWL15-425	4.25	4.25 - 3.88	TWR15-425388	4.25 - 3.75	TWR15-425375	4.25 - 3.50	TWR15-425350
	TWL15-110	—	—	—	—	—	—	—
	TWL15-115	—	—	—	—	—	—	—
	TWL15-463	4.63	4.63 - 4.25	TWR15-463425	4.63 - 3.88	TWR15-463388	4.63 - 3.75	TWR15-463375
	TWL30-080	3.13	3.13 - 2.94	TWR30-080075	3.13 - 2.75	TWR30-080070	3.13 - 2.56	TWR30-080065
	TWL30-085	3.38	3.38 - 3.13	TWR30-085080	3.38 - 2.94	TWR30-085075	3.38 - 2.75	TWR30-085070
	TWL30-090	3.50	3.50 - 3.38	TWR30-090085	3.50 - 3.13	TWR30-090080	3.50 - 2.94	TWR30-090075
	TWL30-095	3.75	3.75 - 3.50	TWR30-095090	3.75 - 3.38	TWR30-095085	3.75 - 3.13	TWR30-095080
	TWL30-100	3.88	3.88 - 3.75	TWR30-100095	3.88 - 3.50	TWR30-100090	3.88 - 3.38	TWR30-100085
	TWL30-105	—	—	TWR30-105100	—	TWR30-105095	—	TWR30-105090
	TWL30-425	4.25	4.25 - 3.88	TWR30-425388	4.25 - 3.75	TWR30-425375	4.25 - 3.50	TWR30-425350
	TWL30-110	—	—	—	—	—	—	—
	TWL30-115	—	—	—	—	—	—	—
	TWL30-463	4.63	4.63 - 4.25	TWR30-463425	4.63 - 3.88	TWR30-463388	4.63 - 3.75	TWR30-463375
TWL30-120	—	—	—	—	—	—	—	
TWL30-500	5.00	5.00 - 4.63	TWR30-500463	5.00 - 4.25	TWR30-500425	5.00 - 3.88	TWR30-500388	
TWL30-130	—	—	—	—	—	—	—	
TWL30-135	5.38	5.38 - 5.00	TWR30-135125	5.38 - 4.63	TWR30-135120	5.38 - 4.25	TWR30-135115	
TWL30-145	5.75	—	—	—	—	—	—	
TWL30-150	—	—	—	—	—	—	—	
TWL30-155	6.13	—	—	—	—	—	—	
AVAILABLE UPON REQUEST								

Tools

Nut A/F (in.)	TWLC2					TWLC4					TWLC8				
	Link Order No.	Radius R (in.)	I (in.)	J (in.)	Weight (Link Only) (lbs.)	Link Order No.	Radius R (in.)	I (in.)	J (in.)	Weight (Link Only) (lbs.)	Link Order No.	Radius R (in.)	I (in.)	J (in.)	Weight (Link Only) (lbs.)
1.13	TWL2-026					-					-				
1.06	TWL2-027					-					-				
1.13	TWL2-029					-					-				
1.19	TWL2-030					-					-				
1.25	TWL2-032	1.24	7.09	1.50	4.41	-					-				
1.31	TWL2-033					TWL4-033					-				
1.38	TWL2-035					TWL4-035					-				
1.44	TWL2-036					TWL4-036					-				
1.50	TWL2-150					TWL4-150	1.44	8.94	2.09	8.82	-				
1.56	TWL2-040	1.36	7.13	1.57	4.41	TWL4-040					-				
1.63	TWL2-041					TWL4-041					-				
1.69	TWL2-043					TWL4-043					-				
1.75	TWL2-044	1.46	7.20	1.57	4.41	TWL4-044	1.54	8.94	2.09	8.82	-				
1.81	TWL2-046					TWL4-046					-				
1.88	TWL2-188					TWL4-188					TWL8-188				
1.94	TWL2-049	1.57	7.28	1.69	4.41	TWL4-049	1.65	8.94	2.09	8.82	TWL8-049				
2.00	TWL2-050					TWL4-050					TWL8-050				
2.06	TWL2-052					TWL4-052					TWL8-052				
2.13	TWL2-054	1.67	7.28	1.69	4.41	TWL4-054	1.75	8.94	2.09	8.82	TWL8-054	1.99	10.79	3.03	15.43
2.19	TWL2-055					TWL4-055					TWL8-055				
2.25	TWL2-057					TWL4-225					TWL8-057				
2.31	TWL2-059	1.79	7.28	1.69	4.41	TWL4-059	1.87	8.94	2.09	8.82	TWL8-059				
2.38	TWL2-060					TWL4-060					TWL8-060				
2.44	-					TWL4-062					TWL8-062				
2.50	-					TWL4-063	1.97	8.94	2.09	8.82	TWL8-063	2.09	10.79	3.03	16.53
2.56	-					TWL4-065					TWL8-065				
2.63	-					TWL4-067					TWL8-067				
2.69	-					TWL4-068	2.09	9.02	2.20	8.82	TWL8-068	2.20	10.79	3.03	16.53
2.75	-					TWL4-070					TWL8-070				
2.81	-					TWL4-071					TWL8-071				
2.88	-					TWL4-073	2.19	9.02	2.20	9.92	TWL8-073	2.30	10.79	3.03	16.53
2.94	-					TWL4-075					TWL8-075				
3.00	-					TWL4-077					TWL8-077				
306	-					TWL4-313	2.32	9.06	2.28	9.92	TWL8-313	2.44	10.91	2.83	17.64
3.13	-					TWL4-080					TWL8-080				
3.19	-					-					TWL8-081				
3.25	-					-					TWL8-083				
3.31	-					-					TWL8-084				
3.38	-					-					TWL8-085	2.64	10.91	2.83	17.64
3.44	-					-					TWL8-087				
	-					-					TWL8-089				
3.50	-					-					TWL8-090				
3.56	-					-					TWL8-091				
3.63	-					-					TWL8-092				
3.69	-					-					TWL8-094				
3.75	-					-					TWL8-095	2.89	10.91	2.83	7.64
3.81	-					-					TWL8-097				
	-					-					TWL8-388				
3.88	-					-					TWL8-100				

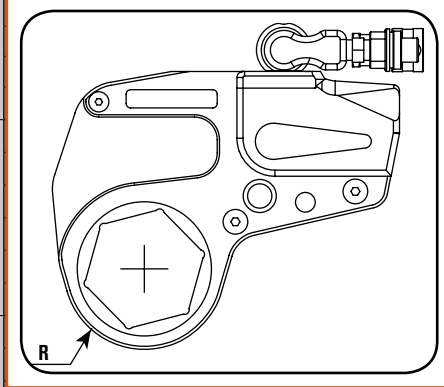

Tools

NOTE:
The sizes listed on these pages encompass both heavy hex and standard hex nut sizes.
Check your local SPX FLOW Power Team Office for availability as some items may be special order.

Nut A/F (in.)	TWLC15					TWLC30					Nut A/F (in.)	TWLC30 (Continued)								
	Link Order No.	Radius R (in.)	I (in.)	J (in.)	Weight (Link Only) (lbs.)	Link Order No.	Radius R (in.)	I (in.)	J (in.)	Weight (Link Only) (lbs.)		Link Order No.	Radius R (in.)	I (in.)	J (in.)	Weight (Link Only) (lbs.)				
2.44	TWL15-062					-					4.81	TWL30-122								
2.50	TWL15-063					-						TWL30-123								
2.56	TWL15-065	2.38	12.32	3.46	27.56	-					4.88	TWL30-124	3.90	15.75	4.29	62.83				
2.63	TWL15-067					-				4.94	TWL30-125									
2.69	TWL15-068					-				5.00	TWL30-500									
2.75	TWL15-070					-				5.06	TWL30-129									
2.81	TWL15-071					-				5.13	TWL30-130									
2.88	TWL15-073	2.48	12.32	3.46	27.56	-					5.19	TWL30-132	4.13	15.75	4.29	62.83				
2.94	TWL15-075					-				5.25	TWL30-133									
3.00	TWL15-077					-				5.38	TWL30-135									
3.06	TWL15-313	2.62	12.32	3.46	28.66	-					5.44	TWL30-538					4.33	15.75	4.29	62.83
3.13	TWL15-080									5.50	TWL30-138									
3.19	TWL15-081					TWL30-080	3.03	15.47	4.09	58.42	5.56	TWL30-140	4.57	15.75	4.29	65.04				
3.25	TWL15-083					TWL30-081					5.63	TWL30-141								
3.31	TWL15-084	2.83	12.32	3.46	29.76	TWL30-083					5.69	TWL30-143								
3.38	TWL15-085					TWL30-084					5.75	TWL30-144					6.06	TWL30-154		
3.44	TWL15-087					TWL30-085					5.81	TWL30-145							6.13	TWL30-155
	TWL15-089					TWL30-087														
3.50	TWL15-090					TWL30-089														
3.56	TWL15-091	TWL30-090																		
3.63	TWL15-092					TWL30-091	3.27	15.47	4.09	58.42	5.88	TWL30-148	4.57	15.75	4.29	65.04				
3.69	TWL15-094					TWL30-092					5.94	TWL30-149								
3.75	TWL15-095	3.07	12.44	3.15	29.76	TWL30-094					6.00	TWL30-150								
3.81	TWL15-097					TWL30-095					6.06	TWL30-151								
	TWL15-388					TWL30-097					6.13	TWL30-152								
3.88	TWL15-100					TWL30-388														
4.00	TWL15-102					TWL30-100														
4.06	TWL15-103					TWL30-102	3.50	15.47	4.09	60.63										
4.13	TWL15-105	3.25	12.44	3.15	30.86	TWL30-103					5.94	TWL30-153								
4.19	TWL15-106					TWL30-105					6.00	TWL30-154								
4.25	TWL15-425					TWL30-106					6.06	TWL30-155								
4.31	TWL15-110					TWL30-425														
4.38	TWL15-111					TWL30-110	3.62	15.47	4.09	60.63										
4.44	TWL15-113					TWL30-111					5.94	TWL30-156								
4.50	TWL15-114	3.44	12.44	3.15	30.86	TWL30-113					6.00	TWL30-157								
	TWL15-115					TWL30-114					6.06	TWL30-158								
4.56	TWL15-116					TWL30-115					6.13	TWL30-159								
4.63	TWL15-463					TWL30-116														
4.69	-					TWL30-463	3.90	15.75	4.29	62.83										
4.75	-					TWL30-119														
						TWL30-120														

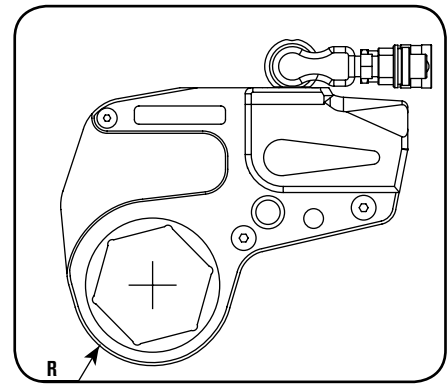

Tools

TO SPECIFY A TWLC SOLUTION:

1. Find a link for your application (nut size)
2. Choose the appropriate drive body
3. Add reducers for additional nut sizes

NOTE: Please order Drive Body and Link separately and pay attention to the same size, for Example TWLC2 and TWL2-041.

TWLC REACTION BAR TWLC-RB

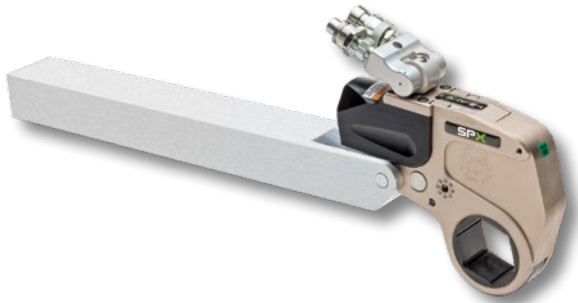

Features

- In-Line Extension Reaction Bar for TWLC wrenches allows extended reach on the same plane
- Pin engagement, no tools required
- Available for full range of tool sizes



Reaction Accessories

Power Team offers a varied range of alternative and optional reaction accessories which help to find a reaction point solution no matter how unusual the bolted application is.

Ordering Information

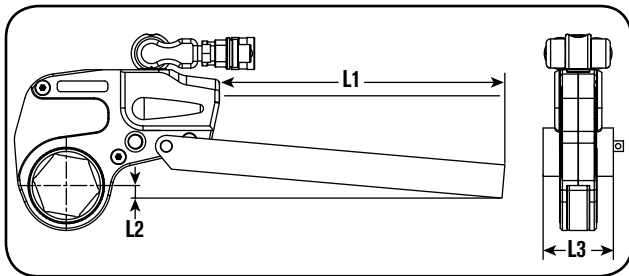

Tool Ref	Order No.	L1 (in.)	L2 (in.)	L3 (in.)
TWLC2	TWLC2-RB	15.00	1.10	2.17
TWLC4	TWLC4-RB	18.00	1.38	2.60
TWLC8	TWLC8-RB	18.00	1.46	3.35
TWLC15	TWLC15-RB	20.00	1.57	4.01
TWLC30	TWLC30-RB	20.00	1.38	5.00

TWLC REACTION PADDLE TWLC-RP



Features

- Off-Set Reaction Arm for TWLC wrenches allows off-set reaction within wrench profile
- Pin engagement, no tools required
- Light alloy construction
- Available for full range of tool

Ordering Information

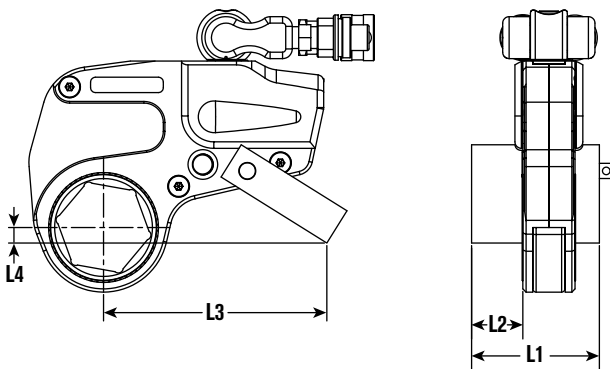

Tool Ref	Order No.	L1 (in.)	L2 (in.)	L3 (in.)	L4 (in.)
TWLC2	TWLC2-RP	3.31	1.38	5.59	0.51
TWLC4	TWLC4-RP	4.29	1.81	7.01	0.75
TWLC8	TWLC8-RP	5.37	2.25	8.66	1.02
TWLC15	TWLC15-RP	6.50	2.76	9.92	1.77
TWLC30	TWLC30-RP	7.874	3.39	12.48	1.73

HAVE A UNIQUE APPLICATION?
DOES STANDARD PRODUCT NOT FIT?



CUSTOM REACTION PADS AND REDUCERS ARE AVAILABLE.

Contact SPX FLOW, or an authorized Power Team distributor, for more details!

WHEN NOTHING ELSE WILL WORK,
SPLIT ADAPTERS ARE MADE TO ORDER
AND AVAILABLE UPON REQUEST.



TWLC15 split adapter,
closed position



TWLC15 split adapter,
open position

Model Shown:

TWSL4-046 Link (left) & TWSL4-060 Link with TWLC4 Drive Body (right)



Features

ENGINEERED TO FIT INACCESSIBLE APPLICATIONS WITH MINIMAL CLEARANCE.

- Dynamic engineering modeling (Finite Element Analysis and optimized tool design to extend life and durability).
- The SlimLine links use the same quick change Drive Body as the existing TWLC links
- Small nose radius, fits all standard API and ANSI flanges.
- Rigid steel body construction with corrosion resistant plating.
- Fully-enclosed drive mechanism for operator safety.
- Swivel manifold has an internal relief valve to prevent retract side over-pressurization.
- Multi-axis swivel technology for free positioning of tool and hoses.

Tools

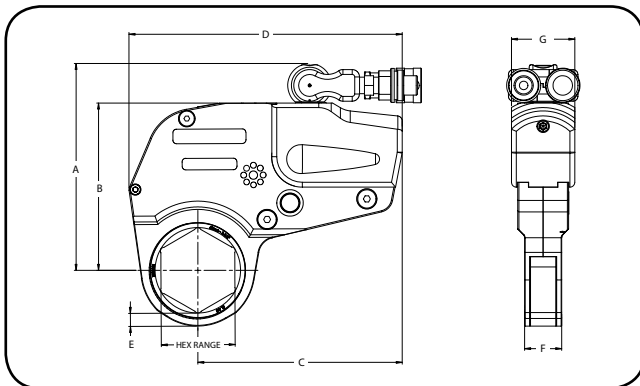

Drive Body interchanges with the TWLC & TWSL link sizes

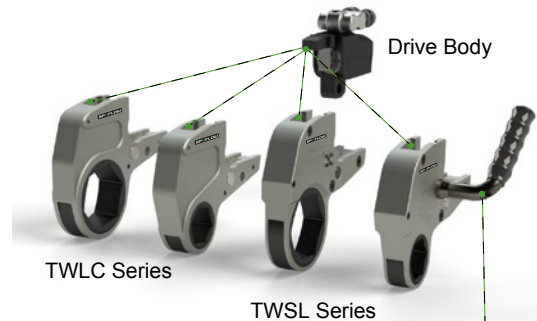

Optional Handle
Order #: DFTAS000002

The Drive Body is designed to interchange with the TWLC (Low Clearance) and the new TWSL (SlimLine) Links, lowering your tool investment across each series to broaden your application reach.

Technical Dimensions

Order No.	A	B	C	D	E	F	G
	(in.)	(in.)	(in.)	(in.)	(in.)	(in.)	(in.)
TWSL4	6.61	5.39	6.61	8.83	0.42	1.20	2.04

NOTE: Sizes; TWSL2-# and TWSL8-#, contact factory for details.

► Technical Fit Overview



► The TWSL's narrow width and reduced radius design enables the tool to fit into tight areas where standard low clearance links cannot.



SlimLine Application Range

Due to the compact design, the maximum torque of the TWSL links vary depending on link size, reference the information below for complete details.

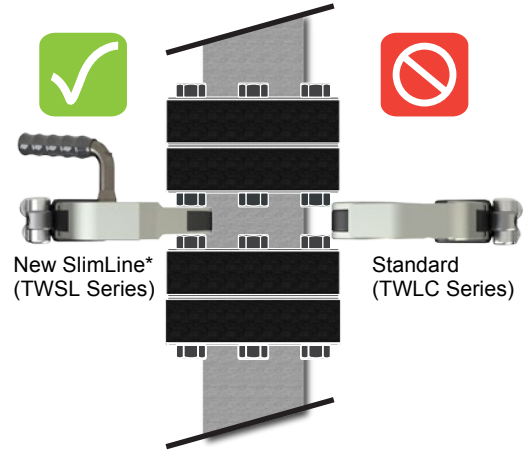

*Shown with optional handle, order # DFTAS000002.

► Torque Wrench Drive Body Ordering Information for SlimLine

Drive Body Order No.	Hex Range for SlimLine		SlimLine Min. Torque (ft. lbs.)	SlimLine Max. Torque (ft. lbs.)	Weight (Link Only) (lbs.)
	(in.)	(in.)			
TWLC2	1.13	2.38	Contact Factory for Details		2.2
TWLC4	1.81	3.13	505	2,639 - 4,210	4.4
TWLC8	2.25	3.94	Contact Factory for Details		7.7

Note: Links are sold separately from the drive body, refer to the tables below.

► Torque Wrench Link Ordering Information for SlimLine

Link Order No.	Hex Range for SlimLine		SlimLine Min. Torque (ft. lbs.)	SlimLine Max. Torque (ft. lbs.)	Weight (Link Only) (lbs.)
	(in.)	(in.)			
TWSL2-#	1.13	2.38	Contact Factory for Details		
TWSL4-#	1.81	3.13	505	2,639 - 4,210	8.0 - 8.4
TWSL8-#	2.25	3.94	Contact Factory for Details		

Note: The “#” suffix will be replaced with the actual link size in a numeric value.

► TWSL4 SlimLine Link Reference Table*

Nut A/F (in.)	Link Order No.	Max. Torque (ft. lbs.)	Weight (Link Only) (lbs.)
1.81	TWSL4-046	2,639	8.0
2.00	TWSL4-050	3,271	8.2
2.19	TWSL4-055	3,568	8.2
2.38	TWSL4-060	3,867	8.3
2.56	TWSL4-065	4,210	8.4
2.75	TWSL4-070	4,210	8.4
2.94	TWSL4-075	4,210	8.4
3.13	TWSL4-080	4,210	8.4



Other Related Items

Contact your nearest Power Team sales representative for assistance in sizing the proper tool for your application, or go to powerteam.com website for details about other available link sizes not listed.



Pumps



Hoses



Tools

Model Shown:
X1E1-PT



Features

THE POWER TEAM X1E1-PT: SOLD FOR YEARS TO END CUSTOMERS.

- Base pump unit: Power Team PE55 series – the standard in the industry
- Two-speed high-performance pump
- Retract side internal relief-valve protects tools
- 4-way / 2-position solenoid valve standard
- Utilizes rugged electrical controls
- External adjustable pressure regulator
- Hand remote standard
- For single or double-acting tools



CAUTION

THIS PUMP SHOULD NOT BE USED FOR LIFTING APPLICATIONS, IT'S DESIGN FOR TORQUE WRENCH APPLICATIONS ONLY.

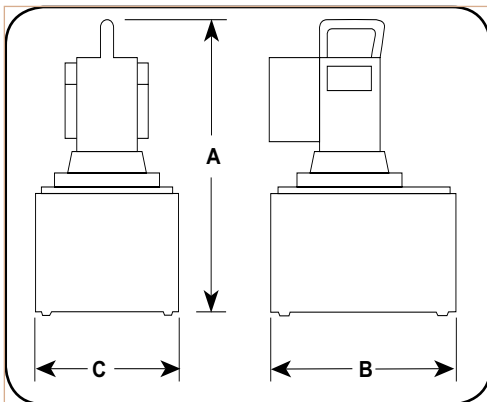

Ordering Information

Order No.	A	B	C	Description	Electric Motor	Oil Delivery per min.	Oil Reservoir Cap.	Prod. Wt.
	(in.)	(in.)	(in.)		Volt	(cu. in.)	(gal.)	(lbs.)
X1E1-PT	18.00	13.00	13.88	Electric-Powered Torque Wrench Pump	110VAC	55	2.5	72.80
X1E2-PT	18.00	13.00	13.88	Electric-Powered Torque Wrench Pump	220VAC	55	2.5	72.80

Model Shown:
X1A1-PT



> Features

X1A1-PT FEATURES THE SAME RUGGED TIME-PROVEN DESIGN AS THE POWER TEAM X1E1-PT.

- Base pump unit, Power Team PA55 series – the standard in the industry
- Two-speed high-performance pump
- Retract side internal relief-valve protects tools
- 4-way / 2-position air valve standard
- External adjustable pressure regulator
- Hand remote standard



CAUTION

THIS PUMP SHOULD NOT BE USED FOR LIFTING APPLICATIONS, IT'S DESIGN FOR TORQUE WRENCH APPLICATIONS ONLY.

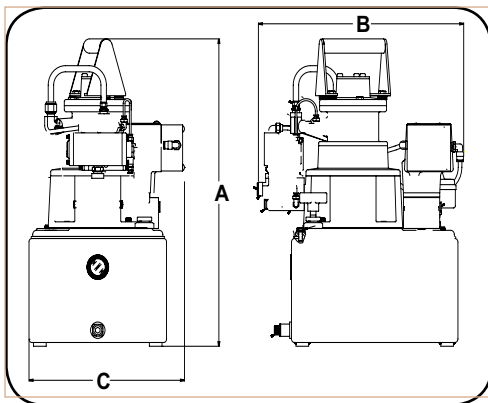

▶ Ordering Information

Order No.	A	B	C	Description	Oil Delivery per min. (cu. in.)	Oil Reservoir Cap. (gal.)	Prod. Wt. (lbs.)
	(in.)	(in.)	(in.)				
X1A1-PT	18.75	18.00	10.75	Air-Powered Torque Wrench Pump	55	2.5	75.00

Tools

Model Shown:
PE30TWP



Features

VANGUARD® ELECTRIC HYDRAULIC TORQUE WRENCH PUMPS.

- Two-speed general duty pump.
- External adjustable pressure regulator.
- Retract side internal relief valve protects tool.
- Hand remote control with 20 ft. cord.
- Use for single or double-acting tools.



CAUTION

THIS PUMP SHOULD NOT BE USED FOR LIFTING APPLICATIONS, IT'S DESIGN FOR TORQUE WRENCH APPLICATIONS ONLY.

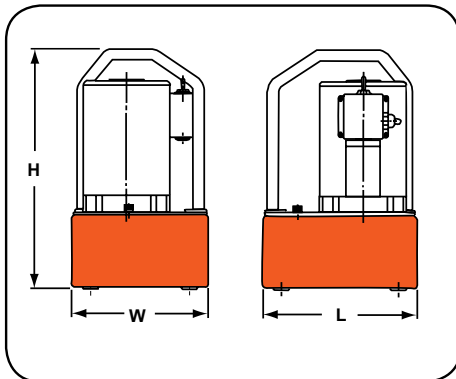

Tools

Ordering Information

Order No.	Width (in.)	Length (in.)	Height (in.)	Electric Motor (4,000 rpm)	Oil Delivery per min. (cu. in.)	Oil Reservoir Cap. (gal.)	Usable Oil (cu. in.)	Prod. Wt. (lbs.)
PE30TWP	13.82	13.13	16.62	1 hp, 115VAC / 60Hz, 13 amps		1.25	280	68.00
PE30TWP-E110*	13.82	13.13	16.62	110VAC / 50Hz, 13 amps	300 @ 100 psi 30 @ 10,000 psi	1.25	280	68.00
PE30TWP-E220*	13.82	13.13	16.62	220VAC / 50Hz, 7 amps		1.25	280	68.00

* CE Approved - designed for 50 Hz applications

Model Shown:

PE55TWP, PE55TWP-4



Features

VANGUARD® ELECTRIC HYDRAULIC TORQUE WRENCH PUMPS.

- Two-speed high-performance pump.
- External adjustable pressure regulator
- Retract side internal relief valve protects tool.
- Hand remote control with 20 ft. cord.
- Use for single or double-acting tools.
- Four-tool manifold allows use of up to four tools simultaneously.



CAUTION

THIS PUMP SHOULD NOT BE USED FOR LIFTING APPLICATIONS, IT'S DESIGN FOR TORQUE WRENCH APPLICATIONS ONLY.

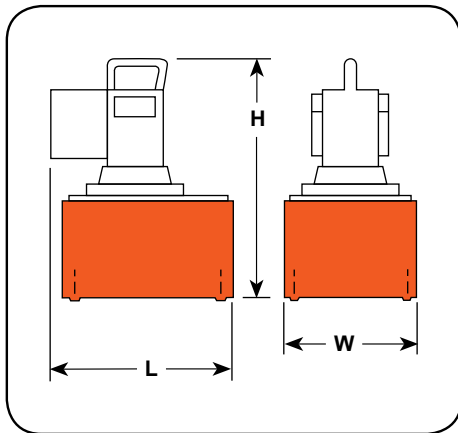

Ordering Information

Order No.	Width (in.)	Length (in.)	Height (in.)	Electric Motor (12,000 rpm)	Oil Delivery per min. (cu. in.)	Oil Reservoir Cap. (gal.)	Usable Oil (cu. in.)	Prod. Wt. (lbs.)
PE55TWP	17.14	9.50	18.12	1-1/8 hp, 115VAC, 25 amps		1.25	280	75.00
PE55TWP-E110*	17.14	9.50	18.12	110VAC / 50Hz, 25 amps	704 @ 0 psi	1.25	280	75.00
PE55TWP-E220*	17.14	9.50	18.12	220VAC / 50Hz, 13 amps	56 @ 10,000 psi	1.25	280	75.00
PE55TWP-4	18.49	9.50	19.15	1-1/8 hp, 115VAC, 25 amps		1.25	280	78.00
PE55TWP-4-E110*	18.49	9.50	19.15	110VAC / 50Hz, 25 amps	704 @ 0 psi	1.25	280	78.00
PE55TWP-4-E220*	18.49	9.50	19.15	220VAC / 50Hz, 13 amps	56 @ 10,000 psi	1.25	280	78.00

* CE Approved - designed for 50 Hz applications

Model Shown:
RWP55-4

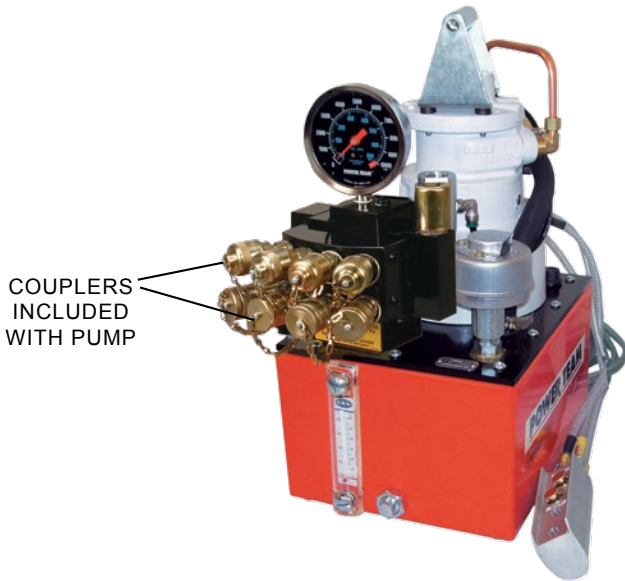

Features

AIR HYDRAULIC TORQUE WRENCH PUMP

- Use where air is the preferred source of power.
- Powerful 3 hp motor starts under load.
- External adjustable pressure regulator.
- Retract side internal relief valve protects tools.
- Use for single or double-acting tools.
- Four-tool manifold allows use of up to four tools simultaneously.
- 25 ft. pneumatic remote controller included.



CAUTION

THIS PUMP SHOULD NOT BE USED FOR LIFTING APPLICATIONS, IT'S DESIGN FOR TORQUE WRENCH APPLICATIONS ONLY.

Tools

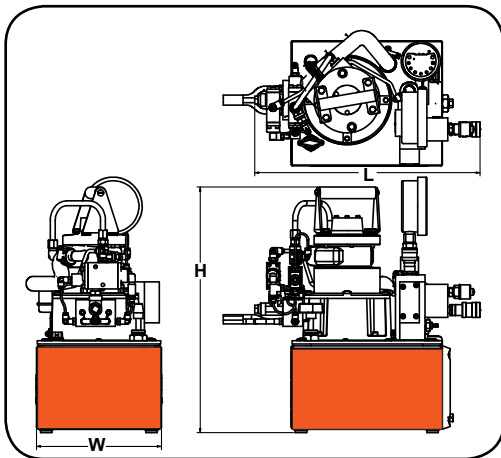

Ordering Information

Order No.	Width (in.)	Length (in.)	Height (in.)	Air Motor	Oil Delivery per min. (cu. in.)	Oil Reservoir Cap. (gal.)	Usable Oil (cu. in.)	Prod. Wt. (lbs.)
RWP55	16.55	9.50	19.83	3 hp, 50 cfm @ 80 psi	465 @ 100 psi 55 @ 10,000 psi	2.50	590	78.00
RWP55-4 (4-TOOL MANIFOLD)	16.55	9.50	19.83	3 hp, 50 cfm @ 80 psi	465 @ 100 psi 55 @ 10,000 psi	2.50	590	78.00

Model Shown:

HNS150, HNS150A, HNS225



Features

HYDRAULIC NUT SPLITTERS

- Specially designed “tool steel” cutter blade penetrates the nut to the precise point where it cracks, stopping short of the bolt threads.
- Dial-in” feature on HNS150 makes adjustment of splitter simple, without the worry of damaging the bolt.
- Nut splitter features a dramatically improved cutter blade with an 800% greater resistance to chipping and breaking over previous models.
- Compact size allows you to use it in confined areas where it will deliver enough force to split the toughest “fused” or rusted-on grade 2H nuts.
- All models feature a rugged one-piece cutting frame coupled to a heavy-duty hydraulic cylinder.

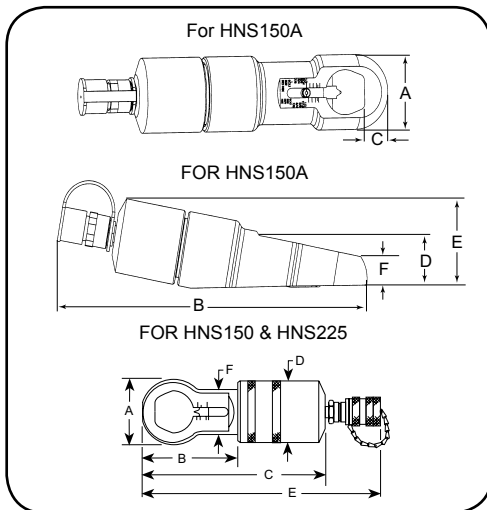

Align mark on cutter blade with scale.



Ordering Information

Order No.	A	B	C	D	E	F	Head Thickness (in.)	Replacement Blade	Prod. Wt. (lbs.)
	(in.)	(in.)	(in.)	(in.)	(in.)	(in.)			
HNS150	2.88	3.38	0.65	2.75	10.38	2.06	1.0	308840	8.10
HNS150A	3.02	14.20	1.03	2.11	3.70	1.16	1.0	351985	15.80
HNS225	4.25	6.00	14.38	3.88	—	3.25	1.5	308022	29.00

NUT GRADE CAPACITIES

Order No.	2 or A	5 or B	8 or C	2H
HNS150	1/2 - 1-1/2 in. hex	1/2 - 1-1/2 in. hex	1/2 - 1-5/16 in. hex	1/2 - 1-1/8 in. hex
HNS150A	1/2 - 1-1/2 in. hex	1/2 - 1-1/2 in. hex	1/2 - 1-5/16 in. hex	1/2 - 1-1/8 in. hex
HNS225	1-1/8 - 2-1/4 in. hex	1-1/8 - 2-1/4 in. hex	1-1/8 - 2-1/16 in. hex	1-1/8 - 1-11/16 in. hex

Model Shown:
FLS15, FLS15-ST



Features

INTEGRATED WEDGE CONCEPT IDEAL FOR CREATING SPACE FOR FLANGE SURFACE CLEANING AND REPAIR

- 33,000 pound wedge-driven spreader. Jaws fully supported by wedge for excellent durability.
- Low friction provided by heavy-duty extended-life lubricant, ideal for flanges with narrow gaps (only 0.2 inches required for entry).
- Compact and lightweight design (only 9.9 inches long at a weight of 7 pounds).
- Ergonomically balanced handle included.
- Suitable for the offshore environment due to superior corrosion resistance
- Quick adjustments for various tasks due to interchangeable shoes (both stepped and serrated)
- Easy and quick maintenance without special tools required.
- Includes female half coupler & mates to standard 3/8" male half coupler (9798).

FLS15 Spreader

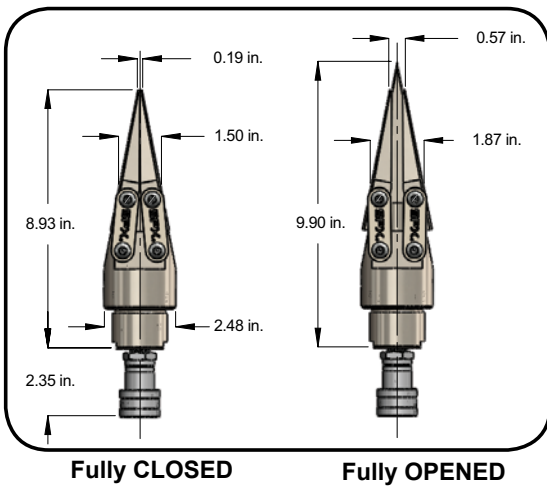

FLS15-ST Spreader

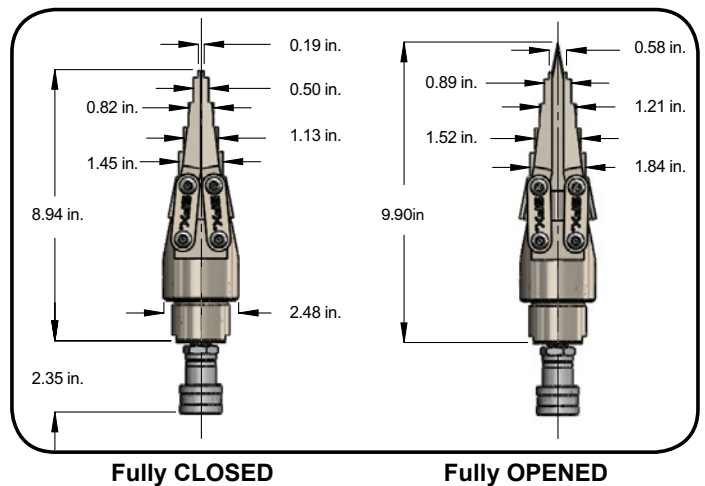

Tools

Order No.	Maximum Spreading Force (lbs.)	Minimum Tip Clearance (in.)	Maximum Tip Spread (in.)	Spreader Type	Oil Cap. (cu. in.)	Maximum Operating Pressure (psi.)	Prod. Weight (lbs.)
FLS15	33,000	0.197 Inches	0.59 Inches	Hydraulic	1	10,000	7.00
FLS15-ST							



TYPICAL APPLICATIONS:

- Pipe and flange repair
- Removing elbows
- Couplers & gasket and metal seal replacement
- Heavy equipment maintenance

OTHER OPTIONAL ACCESSORIES

HANDLE		
	Order No.	Description
	2008410	Lightweight spreaders handle is designed for use with FLS15 or FLS15-ST. Wt., 0.12 lbs.

STEPPED BLOCK		
	Order No.	Description
	SB15	Use to increase the wedge opening. Designed to use with FLS15 or FLS15-ST. (1 piece).



STEPPED SHOE		
	Order No.	Description
	2008083*	Lightweight spreader stepped shoe with an interlocking friction-free smooth, parallel wedge design, Wt. 0.64 lbs.

SERRATED SHOE		
	Order No.	Description
	2008082*	Lightweight spreader serrated shoe.

PUMP		
	Order No.	Description
	P19L	Two-speed, single-acting hand pump . 29 cu. in. oil capacity. Wt. 5.10 lbs.

HOSE		
	Order No.	Description
	9764	Hydraulic hose assembly.

ANALOG GAUGE		
	Order No.	Description
	9040	Pressure gauge.

COUPLER & GAUGE ADAPTER		
	Order No.	Description
	9798	Male half coupler.
	9670	Gauge adapter

* Part number is for one shoe only. Two shoes required per spreader.

Tools

Model Shown:
HFS3A



▶ HFS6AP59L spreader offers up to 10 tons of spreading force to safely separate this flange.



Tools

Features

CONTROLLED AND GUIDED FLANGE SEPARATION TOOL

- You'll never again have to resort to "hammer and chisel" methods that waste time and effort. Flange spreaders should be used in pairs to provide even spreading force.
- Use HFS3A for applications where total thickness of flanges and max. spread gap is 3 or less, and flange bolts are a min. of 0.69" diameter.
- Use HFS6A if total thickness of flanges and max. spread gap is 6" or less, and flange bolts are a min. of 0.81" diameter.



OPTIONAL WEDGE ENDS

Standard 60° wedge is suitable for most flanges; 30° "thin" and 60° "blunt" wedges are optional.



350823



350822



350549



350550

Ordering Information

Order No.	Cap. (ton)	Standard Wedge Type	Optional Wedges		Min. Flange Opening			Min. Flange Opening			Min. Combined Flange Opening (in.)	Pin Dia. (in.)	Prod. Wt. (lbs.)
			30° Thin	60° Blunt	60° Std. (in.)	60° Blunt (in.)	30° (in.)	60° Std. (in.)	60° Blunt (in.)	30° (in.)			
HFS3A	5	60° Sharp	350823	350822	0.06	1.00	0.06	1.25	1.25	0.72	3.50	0.69	9.00
HFS6A	10	60° Sharp	350549	350550	0.06	1.50	0.06	2.00	2.00	0.97	6.56	0.81	18.00

Model Shown:
HS2000, HS3000



Features

HYDRAULIC SPREADERS OFFER A GREATER FORCE THAN TRADITIONAL MECHANICAL TOOLS.

- Use to lift machines to spread concrete forms or rebar and perform straightening jobs.
- Conforms to ASME B30.1 standard.
- High strength alloy steel forged upper and lower jaws on HS2000.
- Jaws are spring-return to retract automatically when pressure is released.

HS2000 (FORGED STEEL)

- 1 ton capacity spreader, full 2,000 lbs. capacity at 10,000 PSI with 4" spread.
- Can be "dead-ended" at 4" spread under full load.

HS3000 (HIGH GRADE DUCTILE IRON)

- 1.5 ton capacity spreader, full 3,000 lb. capacity at 10,000 psi. with 11.5" spread.
- Needs only 1.25" clearance to engage jaws.
- Can be "dead-ended" at 11.50" spread at full load.

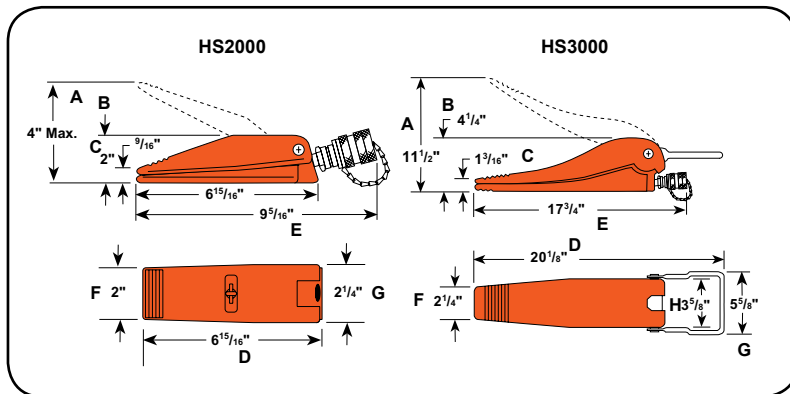

Ordering Information

Order No.	Cap. (ton)	Max. Spread (in.)	A	B	C	D	E	F	G	H	Oil Cap. (cu. in.)	Min. Clearance Required (in.)	Prod. Wt. (lbs.)
			(in.)	(in.)	(in.)	(in.)	(in.)	(in.)	(in.)	(in.)			
HS2000	1.0	4.00	4.00	2.00	0.56	6.94	9.31	2.00	2.25	—	0.63	0.56	4.80
HS3000	1.5	11.50	11.50	4.50	1.19	20.13	17.75	2.25	5.63	3.63	3.50	1.25	22.00

Model Shown:
CC10



Features

- In 5, 10 and 25 ton capacities. For use with Power Team general purpose single-acting series cylinders of comparable capacity.
- For clamping, pressing and bending. Ideal for welding and metal fabrication for fit-up of sheet or plate steel.
- Clamps withstand full rated capacity of the cylinders for which they are intended.

Note: To minimize the effects of off-center loading, the CC5, CC10 and CC25 should be used with the optional 350144 and 350145 swivel caps.

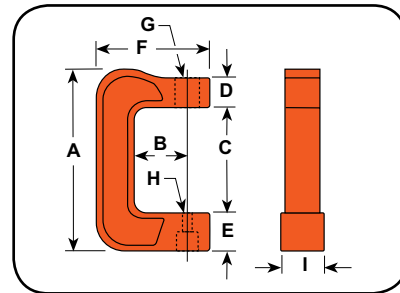

Ordering Information

Order No.	Cap. (ton)	A (in.)	B (in.)	C (in.)	D (in.)	E (in.)	F (in.)	G (in.)	H (in.)	I (in.)	Use With Cyl. No.	Prod. Wt. (lbs.)
CC5	5	12.38	3.75	7.31	2.00	2.50	7.75	1 1/2" - 16 UN	0.88	3.00	C51C-C57C	25.00
CC10	10	15.88	6.00	9.81	2.00	3.00	10.75	2 1/4" - 14 UNS	0.88	3.50	C101C-C1010C	50.00
CC25	25	21.00	6.00	13.00	3.00	4.00	12.31	3 5/16" - 12 UNS	1.44	4.63	C251C-C2514C	96.00

OTHER OPTIONAL ACCESSORIES WITH CC5, CC10 & CC25 HYDRAULIC CLAMPS

SWIVEL CAPS



Order No.	Cap. (ton)	A (in.)	B (in.)
350144*	5 - 10	1.38	0.75
350145	25	2.00	1.00

THREADED ADAPTERS

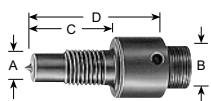

Order No.	Cap. (ton)	A (in.)	B (in.)	C (in.)	D (in.)
38597	10	1 - 8	1 - 8	0.75	2.00
38953	25	1.5 - 16	1.5 - 16	2.75	4.38

V PUSHING ADAPTERS

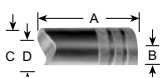

Order No.	Cap. (ton)	A (in.)	B (in.)	C (in.)	D (in.)
34806**	10	2.63	1 - 8	1.50	1.00
34807**	25	3.13	1.25 - 7	1.75	1.25

* May be used with CC5

** Must be used with a threaded adapter.

PUSHING ADAPTERS

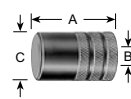

Order No.	Cap. (ton)	A (in.)	B (in.)	C (in.)
25228**	10	2.38	1 - 8	1.50
28229**	25	2.88	1.25 - 7	1.75

PUSHING ADAPTERS

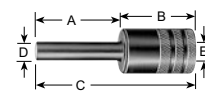

Order No.	Cap. (ton)	A (in.)	B (in.)	C (in.)	D (in.)	E (in.)
201923**	10	3.13	2.25	5.38	0.50	1 - 8
34510**	25	3.25	2.63	5.88	0.75	1.25 - 7

PUSHING ADAPTERS

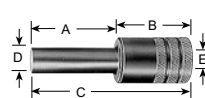

Order No.	Cap. (ton)	A (in.)	B (in.)	C (in.)	D (in.)	E (in.)
201454**	10	3.06	2.63	5.69	0.75	1 - 8
34511**	25	3.25	2.63	5.88	1.00	1.25 - 7

PUSHING ADAPTERS

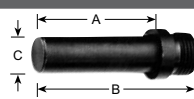

Order No.	Cap. (ton)	A (in.)	B (in.)	C (in.)
309874*	5	2.03	2.78	0.63

Tools

Model Shown:

BB1600



> Features

TIRE REMOVING TOOL

- Made to fit into the pry bar pocket
- Hydraulic pressure does all the unseating.
- Lightweight and portable.



RECOMMENDED PRODUCTS



P59L hydraulic hand pump and 9764 hose recommended to be used with BB1600.

▶ BB1600 bead breaker and the P59L hand pump is the perfect choice for this tire removal application.



▶ **Ordering Information**

Order No.	Cylinder Capacity (@ 10,000 psi.)	Stroke (in.)	Rim Size (in.)	Prod. Wt. (lbs.)
BB1600	11.20	4.00	25" - 49"	22.50
BB1601	11.20	4.00	25" - 49"	24.00

For use with single, two, or three-piece rims

Model Shown:

HP35S



Features

- Punch smooth, precise holes in seconds. Much faster than drilling.
- Fully portable for construction, maintenance and service applications, or can be mounted on a workbench for production jobs.
- Has carrying handle for precise locating.
- Rugged, forged steel C-Frame for great strength and durability.
- Dual-action, spring-loaded stripper holds material during punching operation, strips material from punch on return. Scribe lines on stripper aid in locating the punch.



RECOMMENDED PRODUCTS

The PE172 electric/hydraulic pump is an ideal power source, which is included in item # HP35SP.

Tools

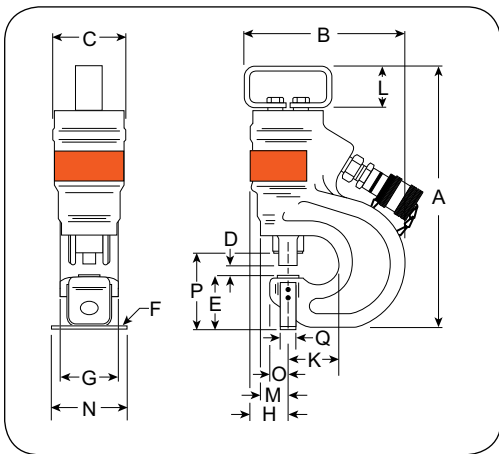

Technical Dimensions

Order No.	Cap. (ton)	Max. Oper. Press. (psi)	Oil Cap. (cu. in.)	Max. Material Thickness (in.)	A (in.)	B (in.)	C (in.)	D (in.)	E (in.)	F (in.)	G (in.)	H (in.)	K (in.)	L (in.)	M (in.)	N (in.)	O (in.)	P (in.)	Q (in.)
HP35	35	10,000	4.6	0.50	13.75	9.00	3.75	0.56	2.88	0.25	3.00	1.81	2.81	2.25	1.50	3.50	0.88	4.00	0.75

Model Shown:
HP35SP



Ordering Information

Order No.	Description	Prod. Wt. (lbs.)
HP35	Punch only, includes metal case and die change tools.	42.50
HP35S	Punch with punches and dies. Includes HP35 punch, metal case and 250459 punch/die set.	44.00
HP35P *	Punch set with pump. Same as HP35SP, but does not include punch/die set.	86.30
HP35SP *	Punch set with pump. Includes HP35 punch, PE172 electric/hydraulic pump, 9756 hose, 9798 hose half coupler, 250459 punch/die set, metal case.	87.80
250459	Punch/die set for round holes. Includes one each: PD437 0.44" punch/die, PD562 0.56" punch/die, PD688 0.69" punch/die, PD812 0.81" punch/die.	1.50

* NOTE: Available in 220VAC, 50 Hz. Order with suffix "-220".

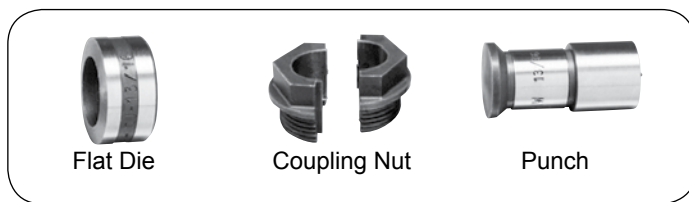

Flat Die

Coupling Nut

Punch



Optional Coupling Nut Wrench



Order No.	Description
252000	Makes punch/die changes easier without "rounding-off" coupling nuts. Wt., 0.5 lbs.

Tools

PUNCH / DIE SETS FOR HP35 HYDRAULIC PUNCHES				
Punch Size (in.)	Punch Style	Hole Dia. (in.)	Punch with Flat Die Set	Punch with Bevel Die Set
0.25	○ Round	0.25	—	—
0.31		0.31	PD313	—
0.38		0.38	PD375	PD375B
0.44		0.44	PD437	PD437B
0.53		0.53	PD531	PD531B
0.56		0.56	PD562	PD562B
0.69		0.69	PD688	—
0.78		0.78	PD781	—
0.81		0.81	PD812	—

Model Shown:
HT50A, HT200



>Features

75 AND 200 GPM IN-LINE HYDRAULIC TESTERS

- Accurately measure oil flow, pressure and temperature on in-plant equipment, forklifts, machine tools and more.
- Temperature and flow readings are in Imperial and Metric and accurate to within $\pm 2\%$ of full scale.
- Dual pressure gauges for high and low pressure readings. Low pressure gauge is automatically shut-off and protected as pressure rises beyond its maximum reading.
- Automatic pressure compensating feature lets you increase flow without affecting pressure setting.
- Reverse flow through tester will not cause damage. A replaceable safety disc ruptures if pressure exceeds upper limit.
- Solid state voltage regulator eliminates errors caused by voltage change during testing.

50 GPM IN-LINE HYDRAULIC TESTER

- Troubleshoots systems with capacities to 50 gpm at pressures less than 5,000 psi. Accurately measure oil flow to $\pm 5\%$, pressure to within 2% and temperature readings within 1%.
- Pressure gauge is liquid filled to dampen system pulsation.

Tools

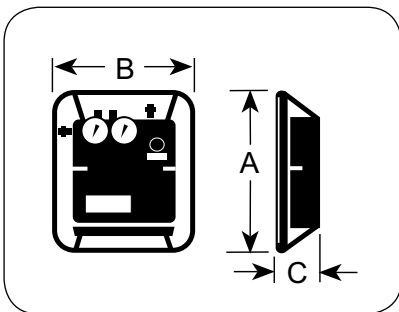

Ordering Information

Order No.	Max. Flow (gpm)	Scale	Flow Range		Max. Oper. Press. (psi.)	Temp. Scale Range (°F)	Port Sizes	A	B	C	Prod. Wt. (lbs.)
			(gpm)	(l/min..)				(in.)	(in.)	(in.)	
HT50A	50	—	0 - 50	0 - 200	5,000	20 - 240	1-1/16-12UN Female O-Ring with Union Adapt 3/4" NPTF female.	12.25	6.25	10.00	30.30
HT75	75	High	15 - 75	50 - 300	5,000	100 - 250	3/4" NPT Swivel	13.75	11.88	5.75	18.20
		Low	3 - 15	10 - 60							
HT200	200	High	25 - 200	100 - 750	5,000	100 - 250	1 1/2" SAE Split Flange	15.88	13.25	6.75	28.20
		Low	5 - 40	20 - 150							

DUAL GAUGE CONVERSION KIT FOR 50 GPM TESTER.



Provides more precise low pressure readings. Remove pressure gauge block and gauge from tester and replace it with this block. Install high pressure gauge from tester (0-5,000 psi) onto this new block.

Order No.	Description
307281	Dual gauge conversion kit. Consists of gauge mounting block, pulsation dampener, thermal overload protector, low pressure gauge and gauge protector. Low pressure gauge calibrated 0-600 psi (0-42 bar). Wt. 1.0 lb.

AUXILIARY POWER CORDS FOR USE WITH 75 AND 200 GPM TESTERS



CAUTION: For use on negative ground systems only.

Order No.	Description
37045	Auxiliary power cord. For use with any 12 or 24VAC battery to remotely power tester. Wt. 0.1 lb.

HOSES



Order No.	Description
9785	Hose, 3/4" I.D. x 3/4" NPTF male both ends. 10 ft. length. 2,250 psi working pressure. (2 req'd on 50 and 75 gpm testers). Wt., 0.7 lb.
9786 *	Hose, 1" I.D. x 1-1/4" NPT male both ends. Recommended max. flow 90 gpm, with a working pressure of 4,000 psi. Wt., 14.0 lbs.
9787 *	Hose, 1-1/4" I.D. x 1-1/4" NPT male both ends. Recommended max. flow 140 gpm, with a working pressure of 3,000 psi. Wt., 21.0 lbs.
9788 *	Hose, 1-1/2" I.D. x 1-1/2" NPT male both ends. Recommended max. flow 200 gpm, with a working pressure of 2,500 psi. Wt., 25.0 lbs.

* Hose assemblies are all 4-ply spiral wound wire, 10 ft. long. For use with 200 gpm testers.

HOSE REDUCER BUSHINGS

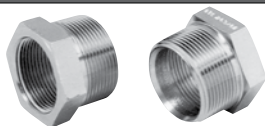

Order No.	Description
203264	Consists of two hose reducer bushings, 1-1/4" NPT female x 1-1/2" NPT male end. Needed to adapt 9786 1" I.D. hose and 9787 1-1/4" I.D. hose to tester. Wt., 2.2 lbs.

Tools



Typical Set-up: Testing the pump, relief valve, and directional valve

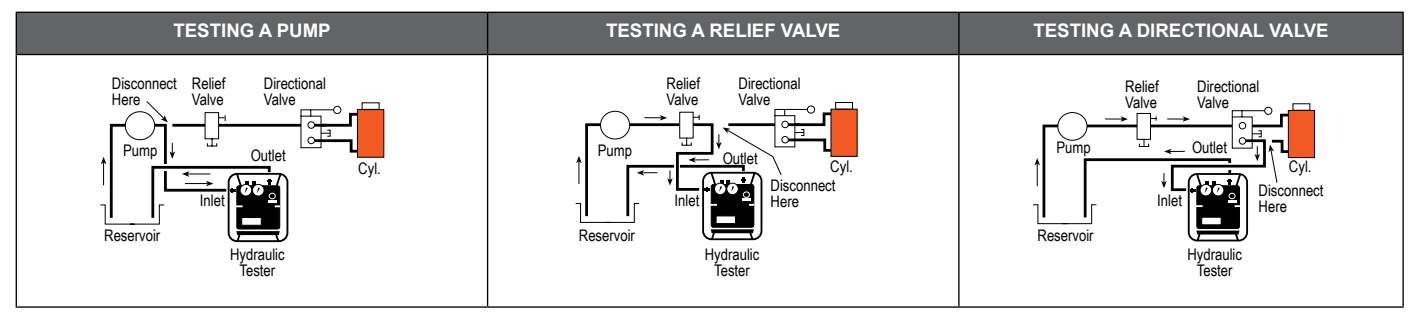

HYDRAULIC FITTINGS FOR USE WITH ALL TESTERS.

	16954	90° Swivel Adapter. 3/4" NPTF male x 3/4" NPSM female. Wt., 0.8 lb.		26073	Swivel adapter. 3/4" NPTF female x 1/2" NPSM female. Wt., 0.3 lb.
	22041	Coupler. 3/4" NPTF male x 3/4"-16 female ORB. Wt., 0.5 lb.		26074	45° Swivel Adapter. 3/4" NPSM female x 3/4" NPTF male. Wt., 0.6 lb.
	22042	Coupler. 3/4" -16 female ORB x 1-1/16"-12 female 37° JIC. Wt., 0.4 lb.		26075	Swivel Adapter. 3/4" NPSM female x 3/4" NPTF female. Wt., 0.4 lb.
	22043	Coupler. 3/4" -16 female ORB x 9/16"-18 female 37° JIC. Wt., 0.4 lb.		26076	Swivel Adapter. 3/4" NPTF male x 3/4" NPSM female. Wt., 0.4 lb.
	22044	Coupler. 3/4" -16 female ORB x 1/2"-20 female 37° JIC. Wt., 0.4 lb.		26077	Cap. 3/4" NPTF. Wt., 0.6 lb.
	27737	Swivel Adapter. 3/4" -16 male x 3/4" NPSM female. For use with No. 9785 hose, which has 3/4" NPTF male thread. Wt., 0.3 lb.		26078	Plug. 3/4" NPTF. Wt., 0.3 lb.
	27287	Coupler. 3/4" -16 UNF female ORB x 7/8"-14 UNF female 37° JIC. Wt., 0.4		26079	Adapter. 3/4" NPTF female x 1-1/16" -12 male ORB. Wt., 0.4 lb.
	13449	Cap. 1-1/16"-12 UNF female, 3/4" O.D. tube, 37° flare. Wt., 0.2 lb.		208402	45° Union Adapter. 7/8"-14 UNF male 37° JIC x 3/4" NPTF female. 3,000 psi working pressure. Wt., 0.6 lb.
	26068	45° Swivel Adapter. 1" NPTF male x 3/4" NPSM female. Wt., 0.8 lb.		208401	45° Union Adapter. 7/8"-14 UNF male 37° JIC x 3/4" NPTF female. Wt., 0.7 lb.
	26069	Swivel Adapter. 1" NPTF female x 3/4" NPSM female. Wt., 0.5 lb.		206753	Coupler. 1-15/16"-12 UNF female 37° JIC x 3/4" NPTF female. Wt., 1.1 lbs.
	26070	Adapter. 1" NPTF male x 3/4" NPTF female. Wt., 0.3 lb.		26666	Connector. 1-5/16"-12 UNF male 37° JIC x 3/4" NPTF male. Wt., 0.4 lb.
	26071	Service Tee. 3/4" NPTF female (2) x 3/4" NPTF male. Wt., 0.9 lb.		28984	Straight Adapter. 3/4" NPTF female x 1-3/16" -12 UN male 37° JIC. Wt., 0.6 lb.
	26072	Swivel Adapter. 3/4" NPSM female x 1/2" NPTF male. Wt., 0.4 lb.		28985	Straight Adapter Union. 1-3/16"-12 UN female 37° JIC x 3/4" NPTF female. Wt., 1.3 lbs.

NOTE: The recommended maximum working pressure on the above fittings is 5,000 psi (except the 208402 is 3,000 psi).

HT200 HYDRAULIC TESTER ACCESSORIES

Attach to the HT200 hydraulic tester by the use of flanged-head adapters and split flanges, or by a set of female straight adapters.



FLANGED HEAD ADAPTER UNIONS & SPLIT FLANGE KIT	
Order No.	Description
203154	Straight flange adapter. 1-1/2" flanged-head to 1-1/2" NPSM female swivel. Wt., 2.2 lbs.
203155	45° flange adapter. 1- 1/2" flanged-head by 1-1/2" NPSM female swivel. Wt., 3.2 lbs.
203156	90° flange adapter. 1-1/2" flanged-head by 1-1/2" NPSM female swivel. Wt., 4.2 lbs.
203017	Split Flange Kit. Consists of four flange halves and attaching bolts to permit use of 1-1/2" I.D. flange adapters listed at left. Wt., 2.9 lbs.

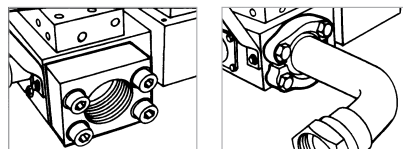



FEMALE STRAIGHT FLANGE ADAPTER	
Order No.	Description
203003	Consists of two female straight flange adapters with attaching bolts. When attached to inlet/outlet ports, allows connection of 1-1/2" NPT male hose ends to tester. Wt., 8.5 lbs.

HORSESHOE LOCK RING PLIER

	For removing horseshoe lock rings used on hydraulic brakes, differentials, etc. Plier is 8" long; max. spread: 15/16"	
	Order No.	Description
	714	Horseshoe lock ring plier. Wt., 0.4 lb.
7313	External snap ring plier easily removes snap rings used to retain bearings on shafts. Max. spread: 17/16".	

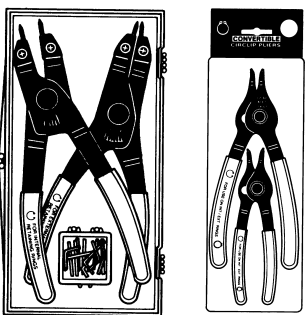
RETAINING RING PLIER KITS

	Choose from four sets; internal ring, external ring and convertible pliers for either internal or external rings.	
	Order No.	Description
	7053K	Replaceable tip pliers kit. This versatile kit contains (1) internal and (1) external pliers with (8) tip sets. Two sets each: .038 dia. 90° bend, .047" dia. straight, .047" dia. 90° bend, .070" dia. straight. Recommended for 1/4"-2" rings. Packaged in plastic storage case. Wt., 0.8 lb.
	15702	Replaceable tip kit (only) for 7053K.
	7123K	Convertible pliers kit. Contains 1120 (.038" dia./straight tip) and No. 1340 (.070" dia./straight tip). Each pliers "converts" to handle both internal and external rings. Packaged in a reusable plastic storage case. Wt., 0.8 lb.
7125K	Convertible pliers kit. Contains 1125 (.038" dia./45° bent tip) and No. 1345 (.070" dia./45° bent tip). Each pliers "converts" to handle both internal and external rings. Packaged in a reusable plastic storage case. Wt., 0.8 lb.	
	7406K	Professional pliers kit. Contains (6) retaining convertible pliers to handle both internal and external rings from 1/4"-2". Includes straight and 90° off-set pliers with .038", .047", and .070" tip diameters. Includes Nos. 1120, 1131, 1320, 1329, 1340 and 1349. Packaged in an impact resistant storage case. Wt., 2.0 lbs.

REPLACEMENT TIPS FOR 7300 AND 7301 PLIERS

Order No.	Description
209201	Replacement tips (pr.) for the 7300 and 7301 pliers. Wt., 0.1 lb. Fed. Spec.:GGG-P-480

RETAINING RING PLIERS SELECTION GUIDE

Order No.	Type of Pliers	Tip Bend	Tip Size Dia. (in.)	For Internal Rings † Bore Dia. (in.)	For External Rings † Shaft Dia. (in.)	Order No.	Type of Pliers	Tip Bend	Tip Size Dia. (in.)	For Internal Rings † Bore Dia. (in.)	For External Rings † Shaft Dia. (in.)
0100	Internal	Str.	0.038	0.375 - 1.023	—	1120	Convertible	Str.	0.038	0.375 - 0.562	0.250 - 0.672
0200	External	Str.	0.038	—	0.250 - 0.875	1125*	Convertible	45°	0.038	0.375 - 0.562	0.250 - 0.672
0300	Internal	Str.	0.070	1.062 - 1.750	—	1131**	Convertible	90°	0.038	0.375 - 0.562	0.250 - 0.672
0400	External	Str.	0.070	—	0.938 - 1.438	1320	Convertible	Str.	0.047	0.625 - 1.023	0.687 - 0.875
0500	Internal	Str.	0.090	1.812 - 3.500	—	1329	Convertible	90°	0.047	0.625 - 1.023	0.687 - 0.875
0600	External	Str.	0.115	—	1.500 - 3.500	1340	Convertible	Str.	0.070	1.062 - 1.750	0.938 - 1.438
7300	Internal	Str.	0.120	3.062 - 6.000	—	1345*	Convertible	45°	0.070	1.062 - 1.750	0.938 - 1.438
7301	External	Str.	0.120	—	3.543 - 6.500	1349**	Convertible	90°	0.070	1.062 - 1.750	0.938 - 1.438

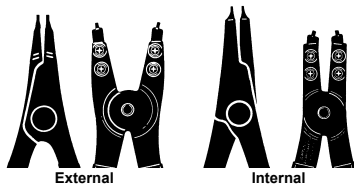

Fed. Spec.:GGG-P-480-E



* 45° Angled Tips

** 90° Angled Tips

† Capacities are shown for basic style rings.

CAUTION: Always wear safety goggles when using pliers

RATCHETING CHAIN WRENCHES

 <p>7400</p>	Special head design allows you to turn wrench in either direction. Ratcheting action makes it possible to re-grip without removal. Fits parts of most any size and shape.	
	Order No.	Description
 <p>7401</p>	7400	Chain wrench, cap. 0.50" to 4.75" O.D. (Capacity= 333 ft. lbs.) Handle length: 12.50". Wt., 2.0 lbs.
	209199	Replacement chain with pin for 7400 chain wrench (16" long).
	7401	Chain wrench, cap. 3" to 6.75" O.D. (Capacity= 666 ft. lbs.) Handle length: 19.00" Wt., 5 lbs.
	209200	Replacement chain with pin for 7401 chain wrench (24" long).

ADJUSTABLE GLAND NUT WRENCH

	Designed to handle 2" to 6" dia. hydraulic cylinder gland nuts on many construction vehicles. Fits 0.25" and 0.31" dia. pin holes. Features a 0.75" sq. drive.	
	Order No.	Description
	1266	Adjustable gland nut wrench. Wt., 3.0 lbs.
	204928	Replacement pin for 1266 (2 required)

ADJUSTABLE HOOK SPANNER WRENCH

	Needed wherever turret adjusting nuts or packing gland nuts are used. Adjust 1.5" to 4". Handle overall length: 19".	
	Order No.	Description
	885	Adjustable hook spanner wrench. Wt., 3.0 lbs.



ADJUSTABLE HOOK SPANNER WRENCH

	Replace many fixed-size wrenches and cover a range of capacities needed to service industrial tractors and other equipment. Drop-forged jaws adjust to eleven positions for a capacity of 4.75" to 12.75" O.D. Handle overall length: 24"; diameter: 1".	
	Order No.	Description
	7307	Spanner wrench with one 0.38" thick jaw. Wt., 7.3 lbs.
	7308	Spanner wrench with two interchangeable jaws: one 0.38" thick, one 0.75" thick. Wt., 11.0 lbs.

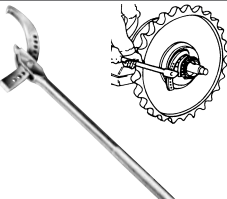
HEAVY-DUTY ADJUSTABLE SPANNER

	Extra heavy construction. Has one 0.75" thick, eleven-position hook-jaw for a capacity of 4.75" to 12.75" O.D. Drop-forged. Handle length: 25.75"; handle dia.: 0.94".	
	Order No.	Description
	7309	Heavy-duty adjustable hook spanner wrench. Wt., 13.3 lbs.

PRY BARS

 <p>7162</p>	Our rolling head pry bars are an extremely popular and useful tool. Head may be used for almost any prying job since a great deal of leverage can be obtained. Long tapered body may be used as a lining-up drift.	
	Order No.	Description
 <p>7163 7164 7165</p>	7162	Pry bar; 0.38" round, 6" long. Wt., 0.3 lb.
	7163	Pry bar; 0.44" round, 12" long. Wt., 0.6 lb.
	7164	Pry bar; 0.56" round, 16" long. Wt., 1.1 lbs.
	7165	Pry bar; 0.75" round, 18" long. Wt., 2.2 lbs.

JIMMY BARS

	Ideal for general lifting or prying. Heat treated chrome alloy steel to resist bending or breaking.	
	Order No.	Description
	7166	Jimmy bar; 0.63" round, 18" long. Wt., 1.4 lbs.
	7167	Jimmy bar; 0.75" round, 24" long. Wt., 2.5 lbs.
	7168	Jimmy bar; 0.88" round, 30" long. Wt., 4.3 lbs.

"MAJOR PERSUADER" JIMMY BARS

	Two big jimmy bars for big jobs. Forged from chrome alloy steel.	
	Order No.	Description
	7420	Jimmy bar; 0.88" round, 46" long. Wt., 7.5 lbs.
	7421	Jimmy bar; 1" round, 54" long. Wt., 11.3 lbs.

HTS50 HEAVY-DUTY PIPE SEALANT WITH PTFE



- Seals new or damaged threads; resists water, chemicals and oils.
- Replaces conventional tape methods; forms a clog-free seal.
- Effective at 10,000 psi.

When “plumbing” a hydraulic system, there’s now a better answer than tapes which can tear or shred, possibly plugging filters, valves or gauges. This compound combines the lubricating qualities of PTFE with a fast curing anaerobic sealant. Seals all metal fittings, plugs and threaded joints quickly and easily. Cures to form a permanent seal which is inert to hydrocarbons, most acids, chemicals, solvents and steam. Allows adjustment up to 16 hours after assembly; won’t loosen under vibration. Prevents galling of mating parts upon disassembly. Withstands temperatures from 65° F to +375° F.

Note: Product labeling may vary from picture.

Order No.	Description
HTS50	Sealant, 50 ml. tube. Wt., 0.4 lb.

O-RING SEAL PICKS

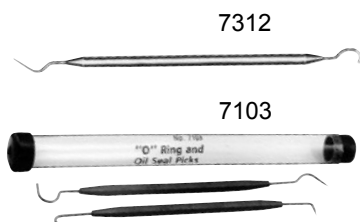

Even the seemingly simple job of removing and installing O-ring seals can be difficult without the aid of the proper tool. The 7312 is constructed with plastic & steel O-ring seal pick does the job with ease. Two special picks in set 7103 get right to the trouble areas.

Order No.	Description
7312	O-ring seal pick. Wt., 0.1 lb.
7103	Set of two O-ring seal picks. Wt., 0.1 lb.

UNIVERSAL OUTSIDE THREAD CHASER



Restore damaged threads on shafts, housings, cages, etc., for re-assembly of matching parts. Eliminates need for thread-cutting equipment. Will not harm threads. V-pads and dies can be replaced. Cap. 1-1/4" to 5" O.D.

Order No.	Description
7402	Thread chaser, complete (with 6 dies: threads per inch – 4, 5, 6, 7, 7.5, 8, 9, 10, 11, 11.5, 12, 14, 16, 18, 20 and 24). Wt., 4.5 lbs.
202817	Metric die set (3 dies: mm per thread: 1, 1.25, 1.5, 1.75, 2, 2.5, 3, 3.5, and 4). Wt., 0.2 lb.

MAGNETIC PICK-UP TOOL



Has permanent magnetic head for retrieving parts from otherwise inaccessible places.

Order No.	Description
7395	Pick-up tool with pocket clip. 6" lg. Wt., 0.1 lb.

Tools

PULLERS

POWER TEAM OFFERS THE WORLD'S MOST COMPLETE LINE OF PULLING EQUIPMENT, ENABLING USERS TO REMOVE AND INSTALL PARTS WITH SPEED AND SAFETY, FOR EFFECTIVE REPAIR JOBS.

Range includes:

- Mechanical Pullers
- Hydraulic Pullers
- Puller Sets
- Bi-Directional™ Pullers
- High Tonnage Pullers
- Accessories & Adapters



	Section / Series	Page Description	Page(s)
	Introduction	Puller Basics: Basic Puller Scenarios, Choosing the Right Pullers	225-228
	1020-1027, 1035-1050	Mechanical 2 & 3-Jaw Pullers	229-230
	927-939	Mechanical Bi-Directional™ Pullers	231-232
	1150-1154, 1165-1166, 1121-1130, 679-680	Pulling Attachments	233-234
	981, SS2, 1178	Blind Hole Puller Set, Slide Hammer Puller Set & Sliding Hammer Only	235
	7136, 1173-1174, 1155-1158	Bearing Cup Remover, Pilot Bearing Pullers, Basic Slide Hammer Units, Reversible-Jaw Slide Hammer Pullers, Slide Hammer Pullers with Cup Pulling Attachments	236
	1180-1182 IPS10B, IPS10HB	Puller Sets	237
		Puller Adapters	239-240
	IPS10M, IPS17M	Manual Puller Sets	241
	PB	Protective Blankets	242
	MB	Metal Boxes	242
	PT, PTPH	Posi-Lock® Mechanical & Hydraulic Pullers & Sets	243-246
	PH63C, PH83C, PH113C, PH303C	Hydra Lock-Jaw™ 2 & 3-Jaw Pullers	247
	K82-K83 HST11, 1188	Lock-Jaw™ Puller Accessories Kits Hydraulic Straightening Tool, Long Jaw Set	248
	PH	Hydraulic Pullers	249-250
	PPH	Bi-Directional™ Hydraulic Pullers	251-252
	IPS	Hydraulic Puller Sets	253-257
	PHP	Bearing Pusher	258
	PH	Enforcer 55 & Enforcer 100	259-260
	PR	Roller Bearing Puller / Installer	261-262
	7180, 27793-27797	Bearing, Bushing, Seal Drivers	263



SELECTING THE RIGHT PULLER:

Step 1 Determine if you are pulling a shaft or hole out of something?

Step 2 Is your application requiring pulling and pushing?

Step 3 What is the reach, spread, and force required to perform the application?

PULLER SIZING CONSIDERATIONS:

1. Determine the type of puller or puller combination needed?
2. Which puller type is best suited for gripping the part?
3. Is a combination of puller types required?
4. Determine the reach needed for your particular pulling problem. The puller you select must have a reach equal, or greater than, the corresponding sizes of the part to be pulled.
5. Determine the spread needed. The spread is determined by the width of the part being pulled. The pullers spread should be greater than the width of the part to be pulled
6. Estimate the force needed to solve your pulling problem. A puller with the proper reach and spread will usually have enough capacity to remove the corresponding part. (Note: When in doubt, always use a puller with a larger capacity than what may be needed. Rusted parts, or parts with a large area of resistance, may need more pulling force).

PULLER SELECTION OPTIONS:

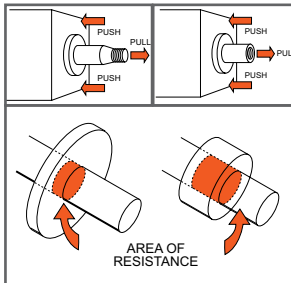

PULLING A PRESS-FITTED SHAFT FROM A HOUSING

A shaft with a threaded end can be removed without damage by using one of our slide hammer, manual or hydraulic Bi-Directional™ Puller, in conjunction with the proper threaded adapter. Removal is easy! If the shaft to be removed has external threads, simply choose one of our female threaded adapters of proper size/thread. If the shaft has internal threads, simply choose the correct size male threaded adapter.

Note: Manual pullers require that the shaft being pulled is no more than twice the diameter of the pullers forcing screw. To determine the recommended tonnage for hydraulic pullers, multiply the diameter of the shaft to be pulled by ten. Example: For a 1" shaft, we recommend 10 tons of pulling force.

SUGGESTED TOOLS:



Slide hammer puller matched with a set of threaded adapters is a perfect tool for light duty pulling needs.

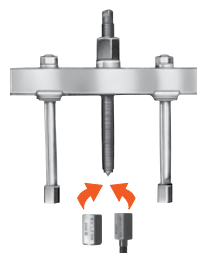

Bi-Directional™ Puller matched with a set of threaded adapters make for an extra versatile pulling tool.

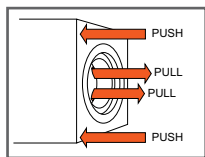

PULLING INTERNAL BEARING RACES, RETAINER, SEALS, ETC.

By extending the narrow jaws of an internal pulling attachment through the center of the part to be pulled, a straight pull is insured, and damage to the housing is avoided. While parts within a “blind hole” in a housing do present a problem, Power Team has the internal pulling attachment or a combination of an internal pulling attachment and puller to handle the situation.

SUGGESTED TOOLS:



Internal pulling attachments have narrow jaws which extend through the center of the part to be pulled. They provide a straight pull and avoid damaging housings. Internal attachments feature adjustable jaws to fit various diameter parts.



Slide hammer with internal attachment is ideal for removing parts from blind holes, especially where there is no housing to brace puller legs against.



Bi-Directional™ Puller with internal attachment is available in both manual and hydraulic versions.

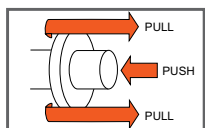

PULLING A GEAR, BEARING, WHEEL, PULLEY, ETC., FROM A SHAFT

In order to perform a proper pull, be certain that you firmly grip the gear, bearing, wheel, pulley, etc., and apply force to the shaft. Use a 3-jaw puller, instead of a 2-jaw, whenever possible for better gripping power and a more uniform displacement of pulling force.

SUGGESTED TOOLS:



Jaw-type pullers:
Either manual or hydraulic. For extra force and convenience, use a hydraulic puller. Both are available in 2 or 3-jaw configurations and are used to grip the outer circumference of a part or can be used with a pulling attachment, such as a bearing / pulley attachment.



Bi-Directional™ Puller:
Can thread directly into a threaded part for easy and secure removal. Bi-Directional™ Pullers can be used in conjunction with bearing/pulley attachments which grip the part from behind. A wide assortment of male and female threaded adapters are available as well as metric adapters.



Slide Hammers:
Best suited for light-duty tasks. Slide hammers can be used for multiple pulling problems when combined pulling attachments.



Bearing/pulley Attachments:
Provide a “knife-like” edge to get behind parts for added versatility and secure removal of parts. Great for parts that don’t offer adequate grip with jaw-type pullers.



Adapters:
Whether you need an adapter compatible with any number of threaded hole sizes, protecting the part to be pulled or for assisting the installation of a component; Power Team offers a variety of adapters to assist in the removal or installation of parts.



▶ Puller with a bearing pulling attachment was used to take a bearing off a utilities well pump motor.

WHY OUR ROLLED PULLER THREADS ARE SUPERIOR:

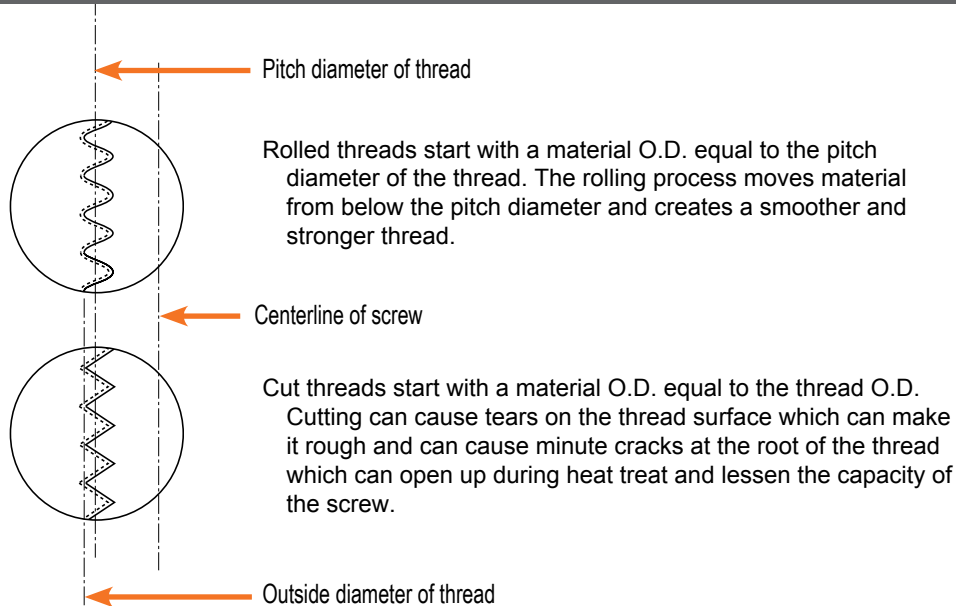

Features	Benefits
<ul style="list-style-type: none"> • Lock-Jaw™ feature on jaw-type pullers. 	<ul style="list-style-type: none"> • The harder the pulling force, the tighter the jaws grip.
<ul style="list-style-type: none"> • 2-way, 3-way and 2/3-way combination pullers: 1 to 37 ton mechanical pullers 2.13" to 27.63" reach 3.25" to 44.00" of spread 5 to 50 ton hydraulic pullers 	<ul style="list-style-type: none"> • Select a specific puller for a specific application, or select one or more pullers for general applications.
<ul style="list-style-type: none"> • Forged alloy steel jaws. 	<ul style="list-style-type: none"> • Strongest possible part. The grain of the material follows the contour of the part.
<ul style="list-style-type: none"> • Machined puller jaw toes. 	<ul style="list-style-type: none"> • Larger and stronger pulling toe than most competitors!
<ul style="list-style-type: none"> • Alloy steel heads (forged or flame cut). 	<ul style="list-style-type: none"> • Heat treated and designed for maximum strength.
<ul style="list-style-type: none"> • Rolled "V" threads. 	<ul style="list-style-type: none"> • Stronger and smoother than cut threads.
<ul style="list-style-type: none"> • Special coating on threads. 	<ul style="list-style-type: none"> • Resists corrosion, traps lubrication better than black oxide.
<ul style="list-style-type: none"> • Heat treated alloy steel cross bolts. 	<ul style="list-style-type: none"> • Designed for maximum shear strength.

▲ CAUTION: The puller application photos shown in this catalog are shown without protective blankets for clarity of photos. Power Team strongly recommends you always make your pull with a protective device in place.



Operator safety comes first!

High levels of force are being exerted with your pulling system. You must respect this force, and observe safety precautions at all times.

A few easy tips to remember:

- 1. Wear safety glasses at all times!** Protect your eyes from possible flying parts.
- 2. Keep your pulling tools in shape!** Clean and lubricate the pullers forcing screw frequently, from threads to tip, to assure long service life and proper operation.
- 3. Cover work with a protective blanket!** With high forces being exerted on the part being pulled, breakage may sometimes result. By covering the work with a protective blanket, reduce the danger of flying parts.
- 4. Apply force gradually!** The component should give a little at a time. Do not try speed removal by using an impact wrench on the puller screw.
- 5. Use the right size puller!** If you have applied maximum force and the part has not moved, go to a larger capacity puller. Resist sledging.
- 6. Align puller legs and jaws!** Be sure the setup is rigid and that the puller is square with the work.
- 7. Mount puller so grip is tight!** Tighten the adjusting strap-bolts when using a jaw type puller. Always use a 3-jaw puller whenever possible. A 3-jaw puller gives a more secure grip, and pulling power. Apply force gradually. Never use an extension on a wrench. Never use an impact wrench. Never strike the end of the forcing screw.
- 8. Do not couple puller legs!** The tonnage capacity of a Bi-Directional™ Puller is reduced when longer than standard legs are used, or when legs are in compression. The chance of breaking, bending or misaligning legs increases. Keep reach to a minimum. Use shortest legs possible to reach the workpiece. Thread legs into workpiece, pulling attachment or adapters evenly. Uneven legs will cause greater pull or push on one side, creating a bending action which could cause damage to workpiece or cause a leg to break. The sliding plates must always be on the opposite side of the cross block from the forcing screw nut or hydraulic cylinder.

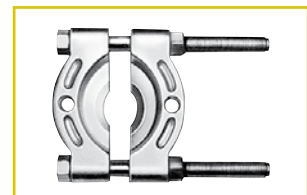
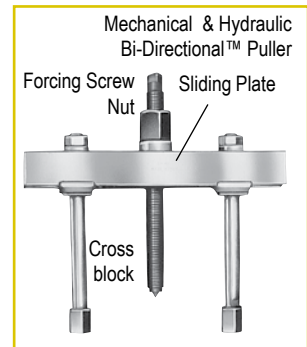

Bearing pulling attachments:

These attachments may not withstand the full tonnage of the pullers with which they are used. The shape and condition of the part being pulled affects the tonnage at which the puller blocks and/or studs may bend or break. Always select the largest attachment which will fit the part to be pulled.



CAUTION

It is impossible to predict the exact force required for every pulling job. Setup requirements and the size, shape and condition of the parts being pulled vary a great deal. In addition, the Power Team pulling system is so versatile, it is possible that components in a pulling setup may have different tonnage ratings.

The lowest “capacity” component, then, determines the capacity of the setup. For example: When an accessory with a 1 ton capacity is used with a 10 ton capacity puller, the setup can be used only at a force of one ton.

These tools should be used only by trained personnel familiar with them.

Always wear eye protection during a job since work parts, or the pulling tool itself, may break and parts may fly. It is recommended to cover the work with a Power Team protective blanket or use a shield while force is being applied.

If you are at all unsure which tool or attachment to select, contact the Power Team factory.

Model Shown:
1024



>Features

VERSATILE DESIGN OFFER A TIGHT GRIP FOR YOUR PULLING APPLICATIONS.

- Lock-Jaw™ feature on all pullers. The harder the pull, the tighter the grip for removing gears, bearings and countless other press fitted parts.
- 2-way, 3-way and 2/3-way combination pullers make it easy to select a specific puller for your application.
- Forged from high quality steel, heat treated and subjected to rigorous tests which exceed rated puller capacity.
- Forcing screw threads are rolled, not cut, creating a smoother and stronger thread.
- Heat treated alloy steel cross bolts for maximum shear strength.
- Machined puller jaw toes produce larger and stronger pulling toes.
- Meets Fed. Spec.: GGG-P-00781-D



Choosing the right size puller

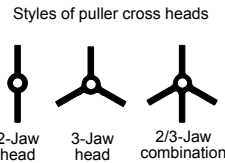

Compare the "reach" and "spread" of the pulling job with that of the pullers listed. The puller selected must have dimensions greater than those of the job.

▶ Two-jaw head puller example.

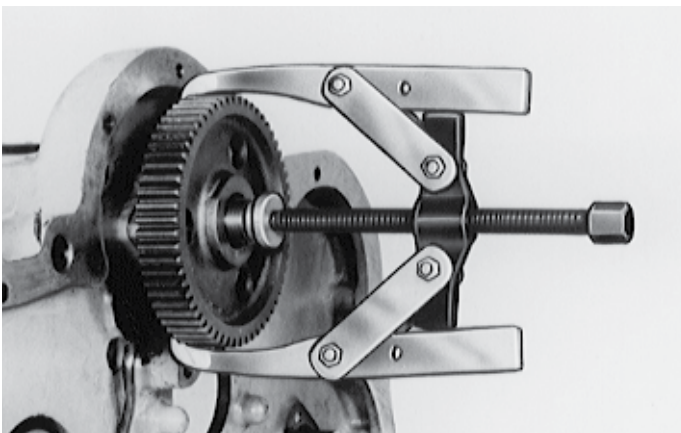

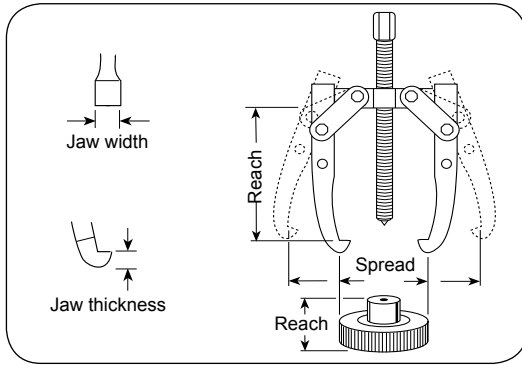

Ordering Information

Order No.	Cap. (tons)	Jaw Type	Max.		Jaw		Screw Size (in.)	Weight (lbs.)
			Reach (in.)	Spread (in.)	Thickness (in.)	Width (in.)		
	1	2-Jaw	2.13	3.25	0.14	0.25	5/16 - 24 x 3.88	0.31
		3-Jaw	2.13	3.25				0.31
	2	2-Jaw *	3.38	4.00	Upper 0.19 Lower 0.13	Upper 0.25 Lower 0.50	3/8 - 24 x 4.88	0.88
		2/3-Jaw *	3.38	4.75				0.88
	5	2/3-Jaw *	3.25	6.00	Upper 0.31 Lower 0.25	Upper 0.38 Lower 0.50	9/16 - 20 x 6.94	0.75
		2/3-Jaw *	3.25	7.00				0.75
	5	Long 2-Jaw *	5.50	6.00	Upper 0.31 Lower 0.25	Upper 0.38 Lower 0.75	9/16 - 20 x 6.94	2.00
		Long 2/3-Jaw *	5.50	7.00				3.63
	7	2-Jaw *	5.00	9.00	Upper 0.31 Lower 0.34	Upper 1.00 Lower 1.00	11/16 - 18 x 9.00	4.50
		2/3-Jaw *	5.00	10.50				6.13
	7	Long 2-Jaw	8.75	9.50	0.34	1.00	11/16 - 18 x 9.00	5.38
		Long 2/3-Jaw	8.75	11.00				8.13
	13	2-Jaw	11.00	12.00	0.56	1.00	13/16 - 16 x 12.00	10.81
		Long 2-Jaw	15.25	15.50				13.00
		2/3-Jaw	11.00	12.00				16.25
		Long 2/3-Jaw	15.25	17.00				18.75
	17.5	Long 2-Jaw	14.50	14.00	0.56	1.00	1 - 14 x 13.50	23.00
		Long 2-Jaw	18.75	16.00				26.00
		3-Jaw	14.50	14.00	0.81	1.28		33.00
		Long 3-Jaw	18.75	16.00				37.00
	25	Long 2-Jaw	22.25	20.00	1.06	1.50	1 1/4 - 12 x 16.63	42.75
		Long 3-Jaw	22.25	20.00				60.00

* Reversible Jaws

Model Shown:
927, 938, 939

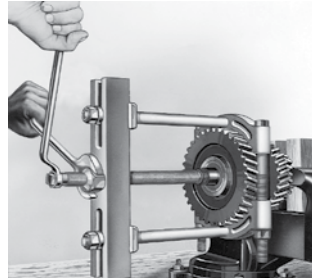
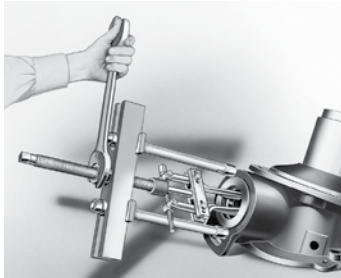

Features

VERSATILE DESIGN OFFERS A TIGHT GRIP FOR YOUR PULLING APPLICATIONS.

- Can apply a pushing or pulling force, depending on how the puller is set up.
- Optional leg kits adapt your Bi-Directional™ Puller to extra long or extra short reach.
- A wide variety of threaded adapters, bearing pulling attachments and internal pulling attachments can be used in combination with our Bi-Directional™ Puller.
- Meets Fed. Spec.: GGG-P-00781-D



Selection and Capacity Rating

Each Bi-Directional™ Puller specified tonnage “capacity” is determined using its standard legs in tension. Using longer legs, or a setup in which the legs are in compression, will reduce the “capacity.” Always select the largest “capacity” puller and the shortest legs that will fit the job.



Puller Adapters



Male/Female

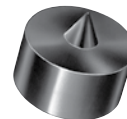

Shaft Protector



Female



Step Plate

For more information, see page 240.

ASSEMBLING THE TOOL TO APPLY PUSHING OR PULLING FORCE:

1. Determine if you want the tool's forcing screw to push or pull.
2. To exert pushing force, the forcing nut is installed beneath the cross block, as shown on left.
3. To cause the forcing screw to pull, the forcing nut is placed on top of the cross block.
4. The sliding plates must always be placed on the opposite side of the cross block from the forcing nut.

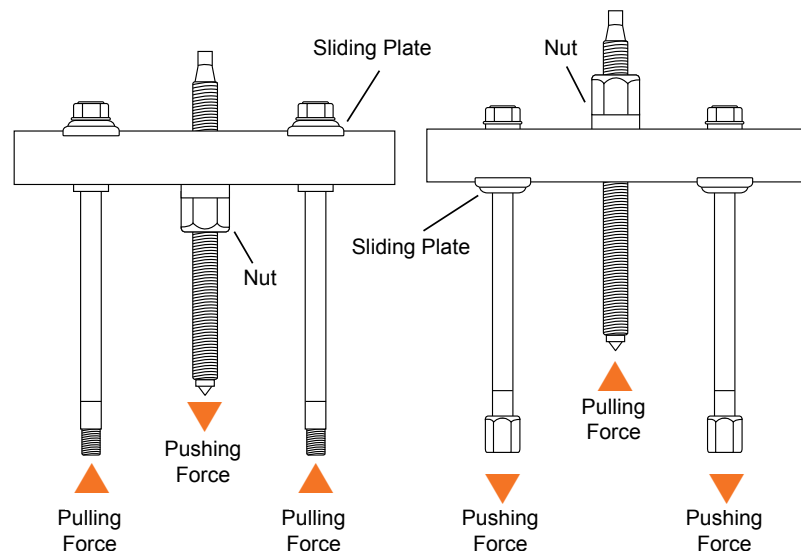

Ordering Information

10 TON MECHANICAL BI-DIRECTIONAL™



10 Ton Capacity can be used with 1123 bearing pulling attachment or 679 pulley pulling attachment. May also be used with 1150, 1151, 1152, or 1153 internal pulling attachments.

Order No.	Max.		Screw Size (in.)	Weight (lbs.)	Notes
	Reach (in.)	Spread (in.)			
927	8.25	2.13 - 7.25	3/4 - 16 x 12.00	7.00	1/2" of forcing screw tip end is threaded 5/8"-18. 1100 legs and 24827 leg ends included.

17.5 TON MECHANICAL BI-DIRECTIONAL™

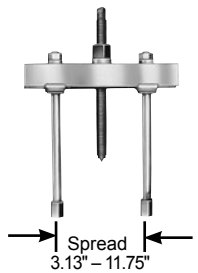

17.5 Ton Capacity can be used with 1124 and 1130 bearing pulling attachments or 679 and 680 pulley pulling attachments. May also be used with 1150, 1151, 1153, 1165, or 1166 internal pulling attachments.

Order No.	Max.		Screw Size (in.)	Weight (lbs.)	Notes
	Reach (in.)	Spread (in.)			
938	11.13	3.13 - 11.75	1 - 14 x 13.25	20.75	Leg ends threaded 5/8"-18. 1106 legs and 24827 leg ends included.

30 TON MECHANICAL BI-DIRECTIONAL™



30 Ton Capacity can be used with 1126 and 1127 bearing pulling attachments or 680 pulley pulling attachment (two 8012 adapters are required to connect 680 to puller). Can be used with 1165 internal pulling attachment.

Order No.	Max.		Screw Size (in.)	Weight (lbs.)	Notes
	Reach (in.)	Spread (in.)			
939	10.50	7.00 - 16.25	1 1/2 - 12 x 17.25	44.00	Leg ends threaded 1"-14. 1109 legs and 28390 leg ends included.

ACCESSORIES - PULLER LEGS

	Order No.	Leg Length (in.)	Weight (lbs.)			Order No.	Leg Length (in.)	Weight (lbs.)	
927	1103	4.75	1.00		938	1104	16.50	6.50	
	1100	6.75	1.50			1105	22.50	9.00	
	1102	11.75	2.25			1108	30.00	11.50	
	1101	15.75	3.25			1109	8.00	8.00	
938	1107	4.50	2.50		1110	18.00	15.00		
	1106	9.50	4.50		1111	28.00	22.00		

Model Shown:

1166



Features

RECOMMENDED FOR THE REMOVAL OF BEARINGS, BEARING CUPS, BUSHINGS AND OIL SEALS.

- Handles internal pulling jobs, such as, bearing/bearing cup removal, bushing removal, oil seals, etc.
- Remove hard to get at parts easily and without damage!
- Use with corresponding Power Team Slide Hammer or Bi-Directional™ Puller
- Adjustable jaws fit various diameters
- Meets Fed. Spec.: GGG-P-00781-D

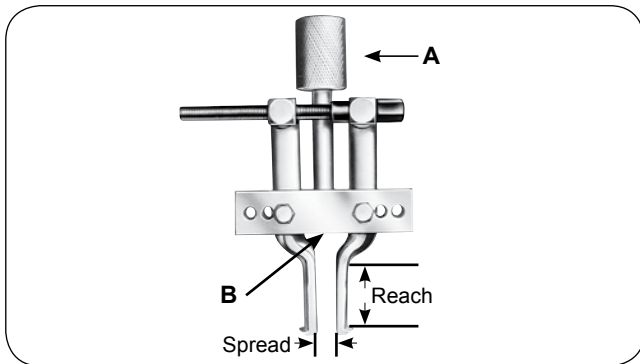

CAUTION

These attachments may not withstand the full tonnage of the pullers they are used with. The shape and condition of the part being pulled affects the tonnage at which the jaws may slip off. Always select the largest attachment which will fit behind the part being pulled.

Ordering Information

Order No.	Jaw		A (in.)	B (in.)	Weight (lbs.)	Application
	Spread (in.)	Reach (in.)				
1153	1.50 - 5.00	2.13	1 - 14	5/8 - 18	4.25	Use with 927 and 938 Bi-Directional™ Puller,
1150	1.50 - 6.00	4.00	1 - 14	5/8 - 18	4.25	
1151	1.50 - 7.00	5.25	1 - 14	5/8 - 18	4.50	
1152	1.50 - 6.00	4.00	—	5/8 - 18	3.50	Use with 927 and 938 Bi-Directional™, 1155 and 1156 slide hammer pullers, or 24832 and 24833 puller screw.
1154	1.50 - 6.00	4.00	1 - 8	5/8 - 18	4.50	Use with PPH17.
1165	3.00 - 9.00	5.88	1 1/2 - 12	1 - 14	13.50	Use with 939 Bi-Directional™ Puller.
1166	3.00 - 9.00	5.88	1 1/4 - 7	1 - 14	13.50	Use with PPH30.

Order No.	Length (in.)	Puller Screws Threads (in. - thd.)	Weight (lbs.)	Application
24832	13.75" long	5/8 - 18	1 lb.	Use with 1150, 1151, 1152, and 1153. Acts as a regular forcing screw when threaded directly into block of pulling attachment.
24833	5.50" long	5/8 - 18	6 oz.	Use with 1150, 1152, and 1153. Acts as a regular forcing screw when threaded directly into block of pulling attachment.

Model Shown:

1122



Features

USED WHERE SPACE DOES NOT PERMIT, HOOKING PULLER JAWS DIRECTLY ON PART TO BE PULLED.

- “Knife-like” edges fit behind bearings and other hard-to-grip parts for easy removal, even where clearance is limited.
- Usable with both Lock-Jaw™ pullers and Bi-Directional™.
- All puller blocks are made from forged alloy steel
- Meets Fed. Spec.: GGG-P-00781-D

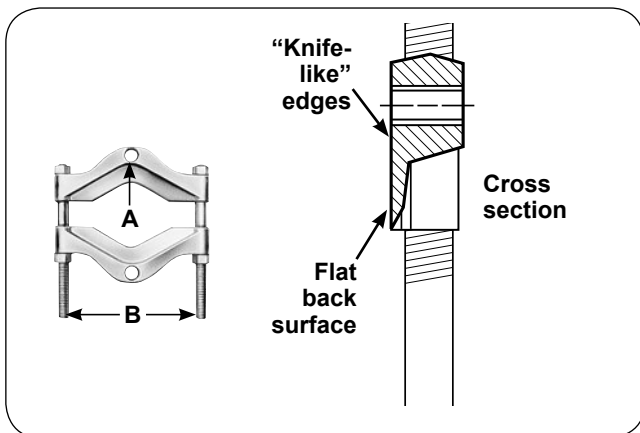

PULLING ATTACHMENT ACCESSORY		
Order No.	Description	
1128	“Knife-like” edges of attachment fit behind bearings or other parts for easy removal with “Enforcer 55”, even if space does not permit hooking puller jaws directly to part being pulled. Spread: 5.00" to 12.88". Wt., 100 lbs.	

Ordering Information

Order No.	Spread		A (in.)	B (in.)	Weight (lbs.)	Application
	Max. (in.)	Min. (in.)				
1121	0.94	0.25	5/16 - 18	1.69	0.75	1020, 1022, and 1023.
1122	2.00	0.13	3/8 - 16	2.44	1.25	1024, 1025, 1026, 1027, 7392 and 7393.
1123	4.63	0.50	5/8 - 18	4.38	5.00	1035, 1036, 1037, 1038, and 927.
1124	5.75	0.50	5/8 - 18	6.00	12.00	1035, 1040, 1041, 1042, PH172, PPH17, and 938.
1126	8.00	0.63	1 - 14	7.50	19.75	1043, and 939.
1127	13.38	0.75	1 - 14	10.25	41.75	939, PH302, and PPH30.
1128	12.88	5.00	1 3/4 - 12	13.00	100.00	PH302*, PH502*, PH553C, and PPH50. (When using 1128 with PPH50, two 8024 adapter are required to connect PPH50 to the puller tees).
1130	9.00	0.50	5/8 - 18	6.00	12.56	1035, 1040, 1041, 1042, PH172, PPH17, and 938.

V-BELT PULLEY PULLING ATTACHMENTS

Order No.	Spread		A (in.)	B (in.)	Weight (lbs.)	Application
	Max. (in.)	Min. (in.)				
679	7.88	1.75	5/8 - 18	6.00	4.25	1035, 1036, 1037, 1038, and 927.
680	10.00	1.63	5/8 - 18	10.06	22.25	1039, 1040, 1041, 1042, PH172, PPH30* and 938. (When using 680 with PPH30, two 8012 adapters are required).

* Indicates discontinued puller model.

BLIND HOLE PULLER SET

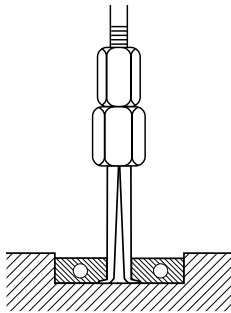

blind hole puller example

Removal of bearings, bushings, sleeves and other friction-fitted parts from blind holes can now be accomplished with ease. Set provides selection of expanding collets 5/16" to 1-3/4" I.D. Collet is placed through bore of part to be removed, then expanded with actuator pin so that lips of collet secure a positive grip for pulling. Pulling force is exerted by means of a forcing screw and bridge assembly or with a slide hammer. Equipped with a plastic case.

Order No.	Description
6981	Blind-hole puller set with slide hammer, forcing screw, bridge, actuator pins, collets, and storage box. Wt., 14.70 lbs.

CONTENTS OF 6981 SET

Order No.	Description	Order No.	Description
24835	Forcing Screw	2009584	Slide Hammer Rod
24836	Forcing Screw Nut	41331	Bridge
22185	Hammer 2.5 lb.	—	Plastic Case - 20" x 15" x 5.5"
2009583	Pin Adapter and Thumb Screw		

Order No.	Description	Order No.	Description	Reach
2009585	Pin 0.140"	2009586	Collet 0.300" - 0.350"	1.50"
2009587	Pin 0.200"	2009588	Collet 0.350" - 0.438"	1.50"
2009589	Pin 0.280"	2009590	Collet 0.438" - 0.563"	1.75"
2009591	Pin 0.400"	2009592	Collet 0.563" - 0.865"	2.50"
2009593	Pin 0.500"	2009594	Collet 0.865" - 1.250"	3.00"

SLIDE HAMMER PULLER SET

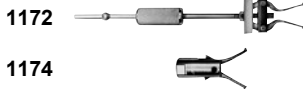

This very handy set is ideal for close-quarters, inside pulling jobs. The slide hammer puller set is very practical for pulling motor, generator, and magneto bearings. It's good for removing small-bore bushings, bearings, and oil seals.

Order No.	Description	Inch Range	
		Min. (in.)	Max. (in.)
SS2	Slide hammer puller set includes both 1172 and 1174. Wt., 5.80 lbs.	1172	0.50 - 2.00
		1174	0.50 - 1.38

SLIDE HAMMER PULLER SET

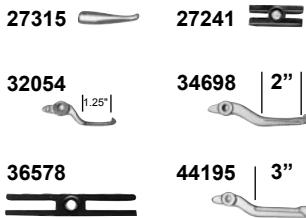

This useful set contains a reversible-jaw slide hammer puller with a 2.5 lb. sliding hammer plus an assortment of special jaws (3 of each size) and adapters. In this set, you get all the versatility you demand of a slide hammer puller.

Order No.	Description
1178	Slide hammer puller set with 2.5 lb. sliding hammer. Wt., 13.80 lbs.

Jaw Order No.	2-Jaw Spread				3-Jaw Spread			
	Inside		Outside		Inside		Outside	
	Min. (in.)	Max. (in.)	Min. (in.)	Max. (in.)	Min. (in.)	Max. (in.)	Min. (in.)	Max. (in.)
44195	1.50	4.50	0.75	5.00	1.50	4.75	1.00	4.50
32054	0.75	2.38	—	—	1.00	2.75	—	—
44148	2.75	5.50	0.75	7.50	3.25	6.25	1.00	6.50
34698	1.25	3.50	1.00	4.50	1.50	4.25	1.50	4.50

SLIDING HAMMERS ONLY

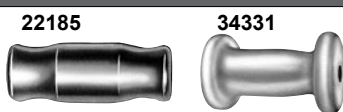

Order No.	Description
22185	2.5 lb. Sliding Hammer.
34331	5.0 lb. Sliding Hammer.

BEARING CUP REMOVER



The 7136 is perfect for pulling internal bearing cups, seals, bushings, etc. With a jaw spread of 0.94" to 3.25", and reach to 3.50". Use with any slide hammer having 5/8"-18 thread (1155, 1156 or 927 Bi-Directional™).

Order No.	Description
7136	Universal bearing cup remover. Wt., 1.50 lbs.

PILOT BEARING PULLERS



1170

These very versatile pullers are built especially for inside pulling jobs, and particularly for removing flywheel pilot bearings on machines and construction vehicles. Also very practical for pulling motor, generator and magneto bearings.

Special slide hammer puller – Ideal for pulling jobs in very close quarters, as in removal of small-bore bushings, bearings, oil seals, etc. Internal pulling attachment has jaw spread of 0.5" to 1.38". The handle end has a 1/2"– 20 thread.

Order No.	Description	Order No.	Reach (in.)	I.D. Spread		Weight (lbs.)
				Min. (in.)	Max. (in.)	
1173	Slide hammer puller. Wt., 3.50 lbs.	1170	0.75	0.50	1.50	4.90
1174	Puller head, less slide hammer. Wt., 0.80 lb.	1171	1.00	0.88	2.13	4.90
		1172	1.75	0.50	2.00	4.90

BASIC SLIDE HAMMER UNITS



1155



1156

Compatible with internal pulling attachment and compatible with threaded adapters. 24" in length, 5/8"-18 threaded end.

Order No.	Description
1155	Basic slide hammer unit with 5.0 lb. hammer. Wt., 7.30 lbs.
1156	Basic slide hammer unit with 2.5 lb. hammer. Wt., 4.80 lbs.

REVERSIBLE-JAW SLIDE HAMMER PULLERS



1176



1177

Ideal for pulling gears, bearings, outer races, grease retainers, oil seals, etc. Two or three jaws may be used and positioned for "inside" or "outside" pulling jobs. Both have 5/8"- 18 threaded end so attachments and adapters may be used.

Order No.	Description
1176	Slide hammer puller with 2.5 lbs. hammer, 27241 two-way head and 34698 jaws.
1177	Slide hammer puller with 5.0 lbs. hammer, 27241 two-way head and 34698 jaws.

Jaw Order No.	2-Jaw Spread				3-Jaw Spread				Length (in.)	Prod. Wt. (lbs.)
	Inside		Outside		Inside		Outside			
	Min. (in.)	Max. (in.)	Min. (in.)	Max. (in.)	Min. (in.)	Max. (in.)	Min. (in.)	Max. (in.)		
1176	1.25	3.50	1.00	4.50	1.50	4.50	1.50	4.50	27.00	8.00
1177	1.25	3.50	1.00	4.50	1.50	4.50	1.50	4.50	27.00	10.50

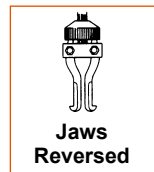

SLIDE HAMMER PULLERS WITH CUP PULLING ATTACHMENTS



1158

These combine a basic slide hammer with 1152 internal pulling attachment for removing oil seals, outer races, and bearing cups from blind holes.

Order No.	Description	Reach (in.)	Spread		Length (in.)	Prod. Wt. (lbs.)
			Min. (in.)	Max. (in.)		
1157	Slide hammer puller consisting of 1156 slide hammer and 1152 internal pulling attachment.	4.00	1.50	6.00	28.00	9.80
1158	Slide hammer puller consisting of 1155 slide hammer and 1152 internal pulling attachment.	4.00	1.50	6.00	28.00	12.30

10 TON CAPACITY BI-DIRECTIONAL™ PULLER SET



Contains three popular Power Team bar-type pullers in one versatile set, packed in a handy plastic storage case. Tools included permit damage-free pulling of gears, bearings, harmonic balancers, and other parts having tapped holes. Ideal for servicing off-road construction equipment and machinery.

Order No.	Description
1180	10 ton Bi-Directional™ puller set in plastic storage case. Wt., 25.00 lbs.

CONTENTS OF 1180 SET

Order No.	Description
927	10 ton Bi-Directional™ puller, 8.38" reach, 2.13" to 7.25" spread. Comes with 6.75" puller legs, other leg sizes are available separately.
522	Gear and pulley puller, spread range when used with 0.50" cap screws is 2.00" to 7.75". (Cap screws not included.)
7393	Gear and pulley puller with standard 5.50" forcing screw, plus special 13.00" forcing screw. Includes two hex head cap screws, 3/8" - 16 x 3.00" long. Spread range: 1.50" to 4.25".

MULTI-PURPOSE PULLER SET



This new assortment of pulling tools gives you a wide range of job versatility. You get a 5 lb. slide hammer puller, hub puller, two sizes of Power Team Lock-Jaw™ pullers, a bearing pulling attachment plus a cross-bar gear and pulley puller, all contained in a handy plastic storage case.

Order No.	Description
1181	Multi-purpose puller set. Wt., 25.00 lbs.

CONTENTS OF 1181 SET

Order No.	Description
1177	Slide hammer puller with 5 lb. hammer, 2-way and 3-way heads. Reversible: either two or three jaws may be used to handle both "inside" and "outside" pulling jobs.
7208	Hub puller. Includes a spare locknut which permits use with 1177 slide hammer.
1023	2 ton combination 2- or 3-jaw Lock-Jaw™ puller. Has 3.38" max. reach, 4.75" max. spread
1027	5 ton combination 2- or 3-jaw Lock-Jaw™ puller. Has 5.50" max. reach, 7.00" max. spread.
7393	Bar-type gear and pulley puller with 5.50" long screw. Includes two hex head cap screws, 3/8"-16 x 3.00" long. Spread range: 1.50" to 4.25".
1122	Bearing pulling attachment for use with 1027 and 7393 pullers. Has 2.00" max. spread, 0.13" min. spread.

LOCK-ON, JAW-TYPE PULLER SET



Components can be assembled to create several versatile puller versions. The puller head is turned to securely lock the jaws onto the part being removed. Both a 2-way and 3-way puller head are included, plus three long-reach and three short-reach puller jaws in a plastic storage box. Easily removes gears, bearings and other press-fitted parts.

Order No.	Description
1182	Jaw-type puller set. Wt., 6.80 lbs

Jaw Order No.	2-Jaw Spread *				3-Jaw Spread *			
	Inside		Outside		Inside		Outside	
	Min. (in.)	Max. (in.)	Min. (in.)	Max. (in.)	Min. (in.)	Max. (in.)	Min. (in.)	Max. (in.)
44195	1.50	4.50	0.75	5.00	1.50	4.75	1.00	4.50
44148	2.75	5.50	0.75	7.50	3.25	6.25	1.00	6.50

* Can be used for internal pulling tasks when used with a slide hammer.

10 TON CAPACITY STRONG BOX PULLER SET



Here's a set of pullers that gives you almost unheard of versatility. This rugged, lockable metal storage cabinet contains pullers, attachments and extra puller jaws good for a variety of applications. Cabinet may be mounted on a wall, stand, or workbench.

Order No.	Description
IPS10B	Cabinet (25.75" x 29.50" x 10.00") with tool board, adapter board, and tool set. Wt., 98 lbs.

CONTENTS OF IPS10B SET

Order No.	Description	Order No.	Description
927	10 ton capacity Bi-Directional™ Puller with 6.75" legs	8013, 8015, 8019	Male-Female threaded adapters (2 ea.)
1027	5 ton combination 2/3-jaw puller	8035, 8037, 8038, 8039, 8040	Female threaded adapters
1037	7 ton combination 2/3-jaw puller		
1101	15.75" puller legs (2)		
1122	Bearing pulling attachment		
1123	Bearing pulling attachment		
1152	Internal pulling attachment		
7393	Gear and pulley puller	8050-8053	Shaft protectors
8005, 8006, 8007, 8010	Male-Female threaded adapters	8057-8062	Step plate adapters
		43892	Long jaws for 1037 (3)
		212867	Cabinet, tool board and adapter board

10 TON CAPACITY HYDRAULIC/MANUAL PULLER SET IN STRONG BOX



This lockable metal Strong Box contains both hydraulic and manual pullers, plus attachments. The rugged storage cabinet keeps the tools organized and secure from unauthorized borrowers!

- Have the puller you need on hand, when you need it.
- Almost unheard of versatility
- Rugged, lockable storage cabinet.
- Wall, stand or workbench mountable.

Order No.	Description
IPS10HB	Cabinet (25.75" x 29.50" x 10.00") with tool board, adapter board, and tool set. Wt., 98 lbs.

CONTENTS OF IPS10HB SET

Order No.	Description	Order No.	Description
PH103C *	10 ton combination 2/3-jaw hydraulic puller	36578	Slotted cross head for slide hammer puller
1027	5 ton combination 2/3-jaw puller	27315	Seal hook for slide hammer puller
1042	13 ton combination 2/3-jaw puller	1152	Internal pulling attachment (1.50" to 6.00" spread)
1177	Slide hammer puller		
44148	3-jaws for slide hammer puller (4.50")	24832	Forcing screw for 1152
44195	3-jaws for slide hammer puller (3.00")	215315	Cabinet and tool board

GEAR AND PULLEY PULLERS

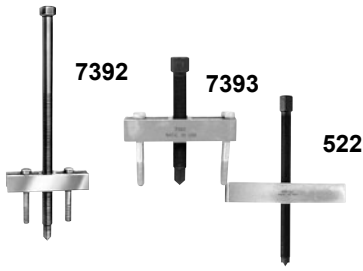

Ideal for pulling many small parts having tapped holes. The 7392 and 7393 may be used with the 1122 pulling attachment to remove bearings, etc. Pullers include two hex head cap screws, 3/8" - 16 NC x 3.00" long. Spread: 1.50" - 4.25". Width of puller block is 4.88". Cap screws are not included with the 522, but any cap screws up to 1/2" diameter may be used. The 522 spread, when used with 1/2" dia. cap screws, is 2"-7 3/4". Width of the 522 puller block is 8.25".

Order No.	Description
7392	Puller with 5/8"-18 x 13.00" long screw. Wt., 2.00 lbs.
7393	Puller with 5/8"-18 x 5.50" long screw. Wt., 1.50 lbs.
522	Puller with 3/4"-16 x 1.63" long screw. Wt., 4.30 lbs.

4-IN-1 PULLER SET



You can quickly assemble a 2 or 3-jaw puller with standard or long reach jaws.

Order No.	Description
PA7	Four-In-One puller set, 7 ton capacity. Standard jaw max. reach is 5.00". Maximum spread is 10.50". Long jaw maximum reach is 8.75". Maximum spread is 11.00". Wt., 10.80 lbs.

FLANGE TYPE PULLER



Slotted holes in puller body permit cap screws to be positioned to handle bolt-circle diameters from 1.50" - 4.63".

Order No.	Description
518	Flange type puller, includes 3 cap screws, 3/8" - 24 NF x 3.00" long and 3 cap screws 3/8" - 16 NC x 3.00" long. Forcing screw is 5/8" - 18 x 5.00" long. Wt., 3.40 lbs.

METRIC ADAPTERS



Add metric capability to the Bi-Directional™ Puller legs or forcing screws! Four separate metric kits available with a variety of sizes for the Bi-Directional™ legs or forcing screws! Each packaged in a convenient plastic organizer case.

Order No.	Description
8110	Male Metric. Wt., 3.00 lbs.
8120	Male Metric. Wt., 3.00 lbs.

CONTENTS OF 8110 SET			
Order No.	Female End (in.)	Male End (in.)	Length (in.)
8111	5/8" - 18	M6 x 1.00	2.25
8112	5/8" - 18	M8 x 1.00	2.25
8113	5/8" - 18	M8 x 1.25	2.25
8114	5/8" - 18	M10 x 1.25	2.25
8115	5/8" - 18	M10 x 1.50	2.25
8116	5/8" - 18	M12 x 1.25	2.25
8117	5/8" - 18	M12 x 1.75	2.00

CONTENTS OF 8120 SET			
Order No.	Female End (in.)	Male End (in.)	Length (in.)
8121	5/8" - 18	M14 x 1.50	2.25
8122	5/8" - 18	M14 x 2.00	2.25
8123	5/8" - 18	M16 x 1.50	2.75
8124	5/8" - 18	M16 x 2.00	2.75
8125	5/8" - 18	M20 x 1.50	2.75
8126	5/8" - 18	M20 x 2.50	2.75

FEMALE THREADED ADAPTERS

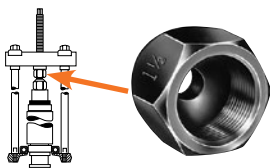

Use these adapters on the ends of Bi-Directional™ Puller forcing screws, legs, or slide hammers in the removal and installation of shafts, axles, and housings.

Order No.	Description
8044	Set No. 8044 - consists of a set of 6 adapters (8037-8042).

Order No.	Female End "A" (in.)	Female End "B" (in.)	Order No.	Female End "A" (in.)	Female End "B" (in.)
8035 *	1/2" - 20	5/8" - 18	8040	5/8" - 18	1" x 14
8036 *	1" - 14	1" x 14	8041	5/8" - 18	1 1/8" - 12
8037	5/8" - 18	5/8" - 18	8042	5/8" - 18	1 1/4" - 12
8038	5/8" - 18	3/4" - 16	8043 *	5/8" - 18	1 1/2" - 12
8039	5/8" - 18	7/8" - 14			

* Not included in set No. 8044. Order separately.

NOTE: All adapters available separately.

MALE-FEMALE THREADED ADAPTERS

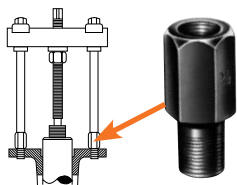

These adapters are used on ends of Bi-Directional™ Puller legs, with forcing screws or slide hammers to assist in pulling shafts, bearing caps, pinions, and many other parts.

Order No.	Female End (in.)	Male End (in.)	Length (in.)
8000	5/8" - 18	1/4" - 20	2.25
8001	5/8" - 18	5/16" - 18	2.25
8002	5/8" - 18	7/16" - 14	2.25
8003	5/8" - 18	7/16" - 20	2.25
8004	5/8" - 18	3/8" - 24	2.25
8005	5/8" - 18	3/8" - 16	2.25
8006	5/8" - 18	1/2" - 20	2.25
8007	5/8" - 18	1/2" - 13	2.25
8008	5/8" - 18	9/16" - 18	2.25
8009	5/8" - 18	9/16" - 12	2.25
8010	5/8" - 18	5/8" - 11	2.25
8011	1" - 14	5/8" - 11	2.50
8012	1" - 14	5/8" - 18	3.19
8013	5/8" - 18	3/4" - 16	2.25
8014	1" - 14	3/4" - 16	2.50

Order No.	Female End (in.)	Male End (in.)	Length (in.)
8015	5/8" - 18	3/4" - 10	2.25
8016	1" - 14	3/4" - 10	2.50
8017	5/8" - 18	7/8" - 14	2.25
8018	5/8" - 18	7/8" - 9	2.25
8019	5/8" - 18	1" - 14	2.25
8020	1" - 8	5/8" - 18	3.00
8021	1" - 8	1" - 4	3.00
8022	5/8" - 18	1/8" pipe	2.25
8023	1 1/4" - 12	1" - 14	4.50
8024	1 1/4" - 12	1 3/4" - 12	4.50
8025	1 1/4" - 7	5/8" - 18	4.00
8027	1 1/4" - 7	1" - 14	4.00
8028	1 5/8" - 5 1/2	1" - 8	4.00
8029	1 5/8" - 5 1/2	1" - 14	4.00

NOTE: Nos. 8000 - 8029 - each sold individually.

STEP PLATE ADAPTER SETS

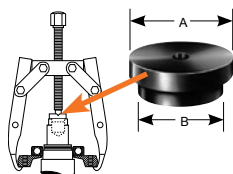

Power Team step plate adapters are necessary for pulling and installing bearings, gears, or other parts on hollow shafts or housings. Puller screw forces against step plate adapter, as shown at right. May be used with Power Team jaw-type pullers, Bi-Directional™ Pullers and shop presses.

Order No.	Description
8075	Set of 11 adapters (8057-8067).
8076	Set of 6 adapters (8068-8073).

CONTENTS OF 8075 SET

Order No.	Dia. "A" (in.)	Dia. "B" (in.)
8057	1.00	0.75
8058	1.13	0.88
8059	1.25	1.00
8060	1.38	1.13
8061	1.63	1.25
8062	1.75	1.38

CONTENTS OF 8076 SET

Order No.	Dia. "A" (in.)	Dia. "B" (in.)
8063	1.88	1.63
8064	2.00	1.63
8065	2.13	1.75
8066	2.38	1.88
8067	2.50	2.00

CONTENTS OF 8076 SET

Order No.	Dia. "A" (in.)	Dia. "B" (in.)
8068	2.63	2.13
8069	2.75	2.25
8070	2.88	2.75
8071	3.00	2.50
8072	3.25	2.75
8073	3.50	3.00

SHAFT PROTECTOR SET

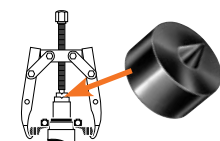

Power Team shaft protectors are designed to protect shaft centers from distortion when extreme pressures are applied with jaw-type pullers or Bi-Directional™ Pullers. Shaft protectors are inserted between the end of the puller screw and the shaft.

Order No.	Description
8056	Set of 6 shaft protectors (8050 thru 8055).

CONTENTS OF 8056 SET

Order No.	Dia. "A" (in.)	Dia. "B" (in.)	"C" (60°) (in.)	"D" (60°) (in.)
8050	1.50	0.75	0.38	0.44
8051	1.25	0.75	0.38	0.38
8052	1.00	0.75	0.38	0.31

CONTENTS OF 8056 SET

Order No.	Dia. "A" (in.)	Dia. "B" (in.)	"C" (60°) (in.)	"D" (60°) (in.)
8053	0.75	0.75	0.25	0.25
8054	0.63	0.63	0.25	0.25
8055	0.63	0.63	0.19	0.19

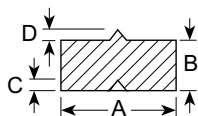

Pullers

▲ CAUTION: All the items shown may not withstand the full tonnage of the pullers they may be used with.

10 TON MANUAL PULLER SET



This puller set is just what you need for removing gears, bearings, etc. Includes pullers, attachments, and many accessories.

Order No.	Description
IPS10M	10 ton capacity. Wt., 53.00 lbs.

CONTENTS OF IPS10M - PULLERS	
Order No.	Description
927	10 ton capacity Bi-Directional™ with 6.75" legs
1023	2 ton combination 2/3-jaw puller
1026	5 ton combination 2/3-jaw puller
1027	5 ton combination 2/3-jaw puller
1037	7 ton combination 2/3-jaw puller
1178	Slide hammer set

CONTENTS OF IPS10M - ACCESSORIES	
Order No.	Description
8075	Step plate adapter set
8044	Female threaded adapter set
8035	Female threaded adapter: 1/2"-20 x 5/8"-18
1151	Bearing cup pulling attachment
1121	Bearing pulling attachment
1122	Bearing pulling attachment
1123	Bearing pulling attachment
1101	15.50" long puller legs for 927 (2)

17.50 TON MANUAL PULLER SET

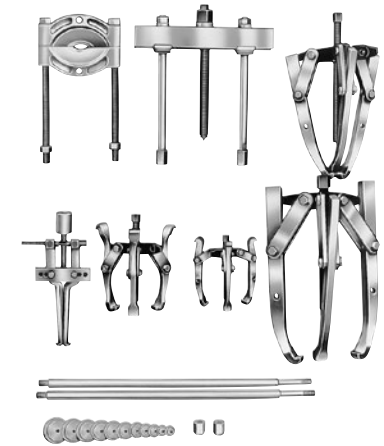

The pullers and accessories in this set can be used for hundreds of applications including quick and easy maintenance involving removal and replacement of press-fit parts.

Order No.	Description
IPS17M	17.50 ton capacity. Wt., 116.00 lbs.

CONTENTS OF IPS17M - PULLERS	
Order No.	Description
938	17.5 ton capacity Bi-Directional™ puller with 9.50" legs
1027	5 ton combo 2/3-jaw puller, with long jaws
1037	7 ton combination 2/3-jaw puller
1041	13 ton combination 2/3-jaw puller
1045	17.5 ton 3-jaw puller

CONTENTS OF IPS17M - ACCESSORIES	
Order No.	Description
8075	Step plate adapter set
1105	22.50" legs for 938
1130	Bearing pulling attachment
1151	Bearing cup pulling attachment
8038	Female adapter: 5/8"-18 F. x 3/4"-16 F. (2)

POWER TEAM PROTECTIVE BLANKET



Our blankets are designed to contain broken or flying parts from the most extreme forces, thus resulting in a much safer work environment.

TESTING RESULTS – In our lab, this style of blanket held the parts of a necked-down grade 8 bolt, which shattered in a 100 ton center-hole hydraulic cylinder. The blanket sustained no visible damage when shot with a force and impact that shattered safety glasses!

PROTECT YOURSELF AND YOUR EQUIPMENT.

- Made of see-through, high-tensile, tear resistant material.
- The clear protective blankets allow you to visually monitor the job from start to finish.
- Effectively contain broken or flying parts from the most extreme pulling, pressing, pushing or stressing forces.
- Ideal for use with pullers and forcing presses.
- Unlike rigid, fixed guards, these blankets can be wrapped and strapped around a job.
- Protective blankets come in a carrying/storage pouch to reduce aging caused by prolonged exposure to light.

Order No.	Size (in.)	Number of Straps	Weight (lbs.)
PB1230C	12 x 30	2	2.80
PB2036C	20 x 36	2	4.20
PB2860C	28 x 60	3	9.30
PB3372C	33 x 72	3	11.70
PB44120C	44 x 120	4	24.20
PB51156C	51 x 156	4	34.40



NOTE: Custom sizes are available on a special order basis. Please consult factory.

JOB-SITE AND MAINTENANCE SECURITY CHESTS

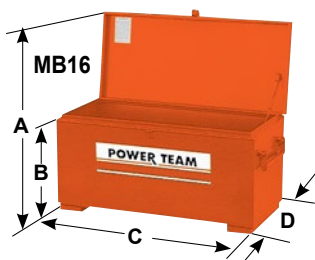

Protect your valuable tools and equipment from theft and weather. When the day's work is finished, you want to rest assured that your tools and equipment will be present the next day. These rugged, lockable chests are the answer that many of our customers have been asking for.

- Rugged, 16 gauge steel construction with fully arc welded seams for extra strength and weather protection.
- Full length piano hinges, mating cover to body, protect against weather and theft.
- Single or double latch security tabs for padlocks.
- Mechanical cover supports, two 2 1/4" high skids.
- Fold-down 3/4" pipe handles on each end of chest.
- Pre-drilled for optional casters, which enhance mobility.
- Durable baked enamel finish.

Order No.	A	B	C	D	Cap. (cu. ft.)	Storage Wt. (lbs.)	Optional Accessories Caster Wheels
	(in.)	(in.)	(in.)	(in.)			
MB5	34.75	14.00	32.00	19.00	5.0	66.00	 251646 – Set of four 4" casters (two swivel and two rigid). Furnished with mounting screws. Wt., 12.50 lbs. 251647 – Set of four 6" casters (two swivel and two rigid). Furnished with mounting screws. Wt., 15.30 lbs.
MB8	39.75	19.00	42.00	19.00	8.8	90.00	
MB16	49.75	24.00	48.00	24.00	16.0	126.00	

Pullers

Model Shown:

Mechanical Pullers (left), Hydraulic Pullers (right)



Features

SAFETY CAGE® GUIDES JAWS FOR FAST SET-UP, SOLID CONTACT AND SUPERIOR SAFETY

- With Power Team Posi-Lock®, pulling bearings is a one-person operation. The T-handle and “Safety Cage®” control the jaws at all times. This means that the opening, closing, locking and aligning of the jaws is all done automatically by simply turning the T-handle.
- Hydraulic pullers come with a lift plate for ease of transport and lifting. In addition, ram points of different sizes are available for a variety of applications
- Using a hydraulic puller system adds efficiency and eliminates unsafe practices such as hammering, heating, or prying components to be removed. The cylinder replaces the center bolt function of a manual puller.
- Pullers are used whenever there are tough maintenance challenges. Examples include: Railroads, Steel & Paper Mills, Mines, Oil Fields, Wind Farms, Factories, Power Plants, Shipyards, etc.

- 1 Hydraulic cylinder reacts off shaft enabling jaws to extract object in a controlled manner.
- 2 Mechanical pullers use a center bolt to provide force on the shaft enabling jaws to extract object in a controlled manner.
- 3 T-handle facilitates the opening, closing, locking and aligning of the jaws.
- 4 Safety Cage® guides jaws for quick setup, providing a “vise-like” grip reducing slippage.
- 5 Forged jaws provides superior durability.
- 6 Slim tapered jaws allow for easier gripping and better access to tight spots.
- 7 Optional hydraulic cylinder tips to meet your application needs.
- 8 Wide range of standard and long jaw reach arms to increase your versatility.



Pullers

Posi-Lock® is a registered trademark of Posi Lock Puller, Inc.

Ordering Information



Optional Accessories

MECHANICAL PULLERS

Long Jaws*

Order No.	Cap. S. Tons	Jaw Qty.	Bolt Dia. (in.)	Reach (in.)	Spread (in.)	Weight (lbs.)	Order No.	Reach (in.)	Spread (in.)
PT202	1	2	0.31	2.25	3.25	0.62	—	—	—
PT203	2	2	0.37	3.00	4.50	1.12	—	—	—
PT204	2	2	0.50	4.00	5.00	3.00	—	—	—
PT206	6	2	0.62	6.00	7.00	7.00	—	—	—
PT208	12	2	0.75	8.00	12.00	12.00	PT11054 PT11054L	9.80 16.00	15.80 22.00
PT210	14	2	0.75	9.67	15.00	13.00	PT11054L	16.00	22.00
PT213	25	2	1.12	12.00	18.00	38.00	PT11354L	20.00	30.00
PT216	35	2	1.25	14.00	25.00	57.00	PT11654L	26.00	38.00
PT102	1	3	0.31	2.25	3.25	0.68	—	—	—
PT103	2	3	0.37	3.00	4.50	1.30	—	—	—
PT104	5	3	0.50	4.00	5.00	4.10	—	—	—
PT106	10	3	0.62	6.00	7.00	8.00	—	—	—
PT108	17	3	0.75	8.00	12.00	14.00	PT11054 PT11054L	9.80 16.00	15.80 22.00
PT110	20	3	0.75	9.67	15.00	16.00	PT11054L	16.00	22.00
PT113	30	3	1.12	12.00	18.00	44.00	PT11354L	20.00	30.00
PT116	40	3	1.25	14.00	25.00	68.0	PT11654L	26.00	38.00

* Long jaws must be ordered in the quantity required. For example, order two PT11054 for the PT208.



Optional Accessories

HYDRAULIC PULLERS

Long Jaws*

Order No.	Cap. S. Tons	Cylinder Included	Jaws Qty.	Reach (in.)	Spread (in.)	Weight (lbs.)	Order No.	Reach (in.)	Spread (in.)
PTPHB-206	5	C55C	2	6.00	8.00	12.70	—	—	—
PTPHB-208	10	C106C	2	8.00	12.00	14.00	PT11054 PT11054L	9.80 16.00	15.80 22.00
PTPHB-210	15	C1510C	2	10.00	15.00	22.00	PTPH-11054L	16.00	22.00
PTPHB-213	25	C2514C	2	12.00	18.00	47.00	PT11354L	20.00	30.00
PTPHB-216	50	C5513C	2	14.00	25.00	90.00	PTPH-21654L	26.00	38.00
PTPHB-106	5	C55C	3	6.00	8.00	14.35	—	—	—
PTPHB-108	10	C106C	3	8.00	12.00	16.00	PT11054 PT11054L	9.80 16.00	15.80 22.00
PTPHB-110	15	C1510C	3	10.00	15.00	25.00	PTPH-11054L	16.00	22.00
PTPHB-113	25	C2514C	3	12.00	18.00	55.00	PT11354L	20.00	30.00
PTPHB-116	50	C5513C	3	14.00	25.00	100.00	PTPH-11654L	26.00	38.00

* Long jaws must be ordered in the quantity required. For example, order three PT11054 for the PTPHB-108.

HYDRAULIC BUNDLES

Power Team offers a comprehensive line of turnkey Posi-Lock® hydraulic two and three-jaw puller sets.



Hand-Operated

2-Jaw Order No.	3-Jaw Order No.	Cap. S. Tons	Cylinder Included	Pump Included	Gauge Included	Hose Included	T Adapter Included
PTPHC-206	PTPHC-106	5	C55C	P19L	9040	9756	9670
PTPHC-208	PTPHC-108	10	C106C	P19L	9040	9756	9670
PTPHC-210	PTPHC-110	15	C1510C	P59L	9040	9756	9670
PTPHC-213	PTPHC-113	25	C2514C	P159	9040	9756	9670
PTPHC-216	PTPHC-116	50	C5513C	P460	9040	9756	9670



Electric-Operated

2-Jaw Order No.	3-Jaw Order No.	Cap. S. Tons	Cylinder Included	Pump Included	Gauge Included	Hose Included	T Adapter Included
PTPHD-206	PTPHD-106	5	C55C	PE172	9040	9758	9670
PTPHD-208	PTPHD-108	10	C106C	PE172	9040	9758	9670
PTPHD-210	PTPHD-110	15	C1510C	PE172	9040	9758	9670
PTPHD-213	PTPHD-113	25	C2514C	PE172	9040	9758	9670
PTPHD-216	PTPHD-116	50	C5513C	PE172	9040	9758	9670

PULLER ACCESSORIES

Power Team offers accessories to compliment your puller. These accessories conveniently store, transport and position your hydraulic pullers to maximize your productivity.



Hydraulic Lift Cart



Storage Transport Cart

Order No.		Puller No. *
Hydraulic Lift Cart	Storage Transport Cart	
PTPT-3050	PTPT-2550	PTPHB-213
PTPT-3050	PTPT-2550	PTPHB-216
PTPT-3050	PTPT-2550	PTPHB-113
PTPT-3050	PTPT-2550	PTPHB-116

* Pullers not included

Note: Accessories only for models shown above.



Versatility and Use



Tapered jaw design allows clamping around bearing for a perfect pull.



Tapered roller bearing on shaft.



Lock on ball grooves and bearing races.

HIGH TONNAGE PULLERS

Power Team Posi-Lock® 100 and 200 ton hydraulic pullers provide maximum extraction force in applications requiring high force removal of large gears, pulleys, wheels, sleeves and other press fit parts. Lifting brackets allow the puller to be removed from the cart and lifted into work places above 5ft.



	Order No.	Cap.	Jaws	Reach	Spread	Tip Width	Tip Clearance	Depth	Weight
		S. Tons	Qty.	(in.)	(in.)	(in.)	(in.)	(in.)	(lbs.)
Single-Acting	PTPH-102T	100	2	50.00	70.00	125.00	3.50	3.50	1700.00
	PTPH-100T	100	3	50.00	70.00	125.00	3.50	3.50	1950.00
	PTPH-123T	100	2/3	50.00	70.00	125.00	3.50	3.50	2000.00
	PTPH-102TV*	100	2	50.00	70.00	125.00	3.50	3.50	1800.00
Double-Acting	PTPH-102TDA	100	2	50.00	70.00	125.00	3.50	3.50	1800.00
	PTPH-100TDA	100	3	50.00	70.00	125.00	3.50	3.50	2050.00
	PTPH-123TDA	100	2/3	50.00	70.00	125.00	3.50	3.50	2100.00
	PTPH-102DATV*	100	2	50.00	70.00	125.00	3.50	3.50	1800.00
	PTPH-200T	200	4	48.00	70.00	125.00	3.50	3.50	4150.00

* Vertical mounted puller.

Note: Each high tonnage puller is equipped with a 115VAC PE55 Power Pump and a C Series Cylinder for single-acting or RD Series Cylinder on double-acting models.
Note: Pushing adapters sized; 3.5" diameter and lengths 9", 19" & 29" are included. Contact factory for other voltage requirements.

PROMOTIONAL GOODS

Showcase your pullers with a branded, reinforced pegboard display in your showroom or shop.



Peg Board Only
Order No. 2008508



Peg Board with Pullers
Order No. PTPM4L

Kit Components	Description	Order No.					
		PTPM4	PTPM4L	PTPM4S	PTPM5	PTPM6	PTMPS16
PTP13/16	TIP PROTECTOR for PT113 / PT213 / PT116 / PT216	—	—	—	—	—	4
PTP10	TIP PROTECTOR PT108 / PT208 / PT110 / PT21	1	2	—	1	2	4
PTP6	TIP PROTECTOR for PT106 / PT206	2	2	2	2	2	2
PTP4	TIP PROTECTOR for PT104 / PT204	1	—	2	1	2	2
PT216	PULLER, MANUAL 2-JAW - 35 TON	—	—	—	—	—	1
PT213	PULLER, MANUAL 2-JAW - 25 TON	—	—	—	—	—	1
PT210	PULLER, MANUAL 2-JAW - 14 TON	—	1	—	—	1	1
PT208	PULLER, MANUAL 2-JAW - 12 TON	—	—	—	—	—	1
PT206	PULLER, MANUAL 2-JAW - 6 TON	1	1	1	1	1	1
PT204	PULLER, MANUAL 2 JAW - 2 TON	—	—	1	—	1	1
PT203	PULLER, MANUAL 2-JAW - 2 TON	—	—	—	—	—	1
PT202	PULLER, MANUAL 2-JAW - 1 TON	—	—	—	—	—	1
PT116	PULLER, MANUAL 3-JAW - 40 TON	—	—	—	—	—	1
PT113	PULLER, MANUAL 3-JAW - 30 TON	—	—	—	—	—	1
PT110	PULLER, MANUAL 3-JAW - 20 TON	1	1	—	1	1	1
PT108	PULLER, MANUAL 3-JAW - 17 TON	—	—	—	—	—	1
PT106	PULLER, MANUAL 3-JAW - 10 TON	1	1	1	1	1	1
PT104	PULLER, MANUAL 3-JAW - 5 TON	—	—	—	—	—	1
PT103	PULLER, MANUAL 3-JAW - 2 TON	—	—	—	1	—	1
PT102	PULLER, MANUAL 3-JAW - 1 TON	—	—	—	—	—	1
2008505	TOOL BOARD KIT, POSI-LOCK® TOOL SETS	1	1	1	1	2	2

Pullers

Model Shown:

PH303C, PH63C, HST11S, PH82K



Features

SELF CONTAINED PULLER SYSTEMS ENABLES FAST AND QUICK SETUP

- Power Team pullers are tested for top performance and reliability at maximum capacity and jaw spread.
- Easily metered release valve control knob.
- Spring loaded live centering cone.
- Bladder type oil reservoir.
- Rapid adjustment.
- Use with 2 or 3-jaws.
- Supplied with a sturdy storage/carrying case.
- Features Power Team's exclusive PowerThon™ Limited Lifetime Warranty.

HYDRA LOCK-JAW™ PULLING SYSTEM

These pullers are ideal for pulling a wide variety of press-fitted parts including bushings, bearings, wheels, gears and pulleys. Hydra Lock-Jaw™ pullers have been rigorously tested for top performance and reliability. PH82K is a complete pulling system which includes a hydraulic power module, 2-way puller head, jaws, legs and bearing splitter attachment, all contained in a convenient carrying case.

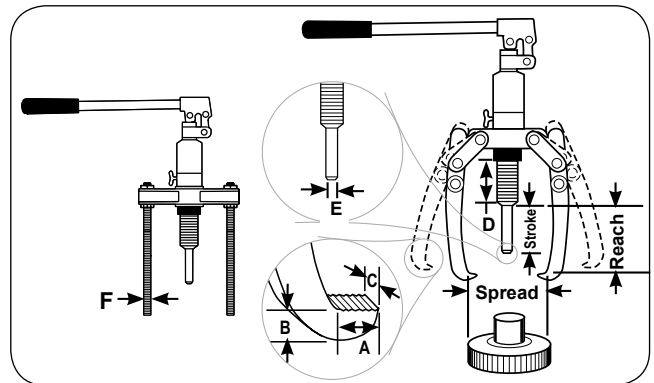

Pullers

Ordering Information

Order No.	Cyl. Cap. (ton)	Reach Studs (in.)	Min. Jaws (in.)	Max. Reach (in.)	Spread Studs (in.)	Jaws (in.)	Stroke (in.)	A	B	C	D	E	F	Weight (lbs.)
								(in.)	(in.)	(in.)	(in.)	(in.)	(in.)	
PH63C	6	—	6.00	—	—	7.88	3.13	0.44	0.25	0.88	3.25	0.88	—	10.80
PH83C	8	—	7.50	—	—	9.81	3.13	0.44	0.38	1.00	3.25	1.13	—	14.50
PH113C	15	—	9.00	—	—	11.00	3.13	0.56	0.38	1.13	3.25	1.13	—	17.60
PH303C	30	10.50	14.75	—	—	21.25	3.13	1.06	1.44	0.50	6.69	2.13	5/8-18 UNF	112.00
PH82K	8	10.50	8.16	4.91	11.80	9.91	3.13	0.36	1.00	0.63	3.25	0.88	5/8-18 UNF	35.00
HST11S*	11	—	5.91	—	—	16.13	3.13	—	—	—	3.25	0.88	—	32.00

* Max bar size 2.3622"

LOCK-JAW™ PULLER ACCESSORY KITS FOR THE HYDRA LOCK-JAW™ PULLER NO. PH83C



Order No.	Description
K82	Accessory kit for the Hydra Lock-Jaw™ puller PH83C. Includes 2-way puller head, 2-jaws, 2 threaded legs and sturdy carrying/storage case. Wt. 13.70 lbs.

LOCK-JAW™ PULLER ACCESSORY KITS FOR THE PH83C LOCK-JAW™ HYDRAULIC PULLER



Order No.	Description
K83	Accessory kit for PH83C Hydra Lock-Jaw™ hydraulic puller. Includes 2/3-way puller head, 3-jaws, 3 threaded legs (5/8-18 thread) and sturdy carrying/storage case. Also can be used with 1123, 1124, 1130 pulling attachments. Wt. 23.00 lbs.

PULLER ACCESSORY CONVERTS PH113C INTO A HYDRAULIC STRAIGHTENING TOOL

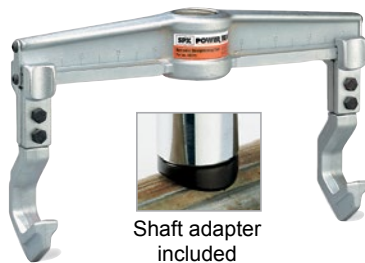

Good for straightening mechanical shafts, round bars, etc. Simply remove pump and cylinder from puller head and insert them into the straightening tool accessory. This product is widely used in steel mills, wire roll companies, wire extruding companies, textile industry, and any straightening situation where portability and power are required. Contoured heat-treated shaft adapter included.

Order No.	Description
HST11	Spread: 3.50" to 16.13", Reach: 5.91". Wt., 21.00 lbs.

LONG JAW SET FOR PH83C AND PH113C LOCK-JAW™ PULLERS



This long jaw set is the perfect addition to the PH83C or PH113C Lock-Jaw™ hydraulic pullers. The extra long jaws give you the added capability of pulling a wider variety of parts. Jaw capacity is 8 tons when used with the PH83C puller; 15 tons when used with the PH113C puller.

Order No.	Description
1188	Spread: 11.00" to 12.50", Reach: 12.50". Wt. 11.50 lbs.

Model Shown:

PH53CR, PH172, PH303



Features

REMOVE GEARS, BEARINGS, AND OTHER PRESS-FITTED PARTS WITH SPEED AND EASE.

- Broad capacity range of 5, 10, 17.5, 30 and 50 tons.
- 5 and 10 ton sets include: single-acting, spring return hydraulic cylinder, hose, coupler dust cap, single-speed hydraulic hand pump, and puller.
- 17.5, 30 and 50 tons sets include: Power-Twin® single-acting, spring return hydraulic cylinder, hose, coupler dust cap, single-speed hydraulic hand pump puller, adjusting screw and crank.
- Hydraulic cylinder of all models is readily removable from puller for use with pump in other hydraulic applications. You get maximum maintenance versatility for your investment.
- Fed. Spec.: GGG-P-00781-D

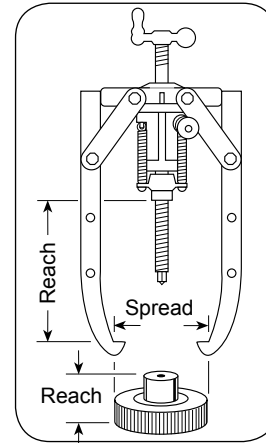

CAUTION: Always use a 3-jaw puller where clearance permits in order to provide a more stable setup and a more even pulling force.

Ordering Information - Puller Only

Order No.	Cap. (ton)	Jaws	Jaw Reach (in.)	Jaw Spread (in.)	Jaw Thickness (in.)	Jaw Width (in.)	Weight (lbs.)
1057	5	2/3	8.75	11.50	0.34	0.98	7.80
1060	10	2/3	15.00	17.00	0.56	0.98	17.00
1064	17.5	2	11.50	16.00	0.81	1.28	22.00
1066	17.5	3	11.50	20.00	0.81	1.28	36.00
1074	30	3	19.44	34.00	1.13	1.63	90.00
1080	50	3	27.88	44.00	1.41	1.88	191.00

5 TON CAPACITY, 2/3-JAW PULLER



Order No.	Description
PH53C	Combination 2-jaw/3-jaw puller set. Includes 1057 5 ton puller, RPS55 hydraulic set (C55C cylinder, P12 hand pump, fittings, coupler, and 6 ft. hose), and 309874 pushing adapter. Wt., 20.00 lbs.
PH53CR	Combination 2-jaw/3-jaw puller set. Includes 1057 5 ton puller, C55C cylinder, and 309874 pushing adapter. Wt., 12.00 lbs.
1057	5 ton cap. 2-jaw/3-jaw puller only. Wt., 7.80 lbs.
AVAILABLE COMPONENTS	
Order No.	Description
309874	0.63" diameter pushing adapter. (Included with PH53C and PH53CR hydraulic puller sets). Wt., 0.30 lb.
309875	0.88" diameter pushing adapter. Wt., 0.80 lb.
47997	2-way/3-way puller head. (Can be used to convert 1038 7 ton manual puller into a 5 ton hydraulic puller). Wt., 2.30 lbs.

Pullers

10 TON CAPACITY, 2/3-JAW PULLER

	Order No.	Description
	PH103C	Combination 2-jaw/3-jaw puller, 10 ton capacity. Set includes 1060 10 ton puller, RPS1010 cylinder and pump set, and 202179 threaded adapter. Wt., 52.00 lbs.
	PH103CR	Combination 2-jaw/3-jaw puller, 10 ton capacity. Set includes 1060 10 ton puller, 202179 threaded adapter, and C1010C cylinder only. (Pump and hose not included). Wt., 32.00 lbs.
	1060	Combination 2-jaw/3-jaw puller only. 10 ton capacity. (Cylinder and pump set, hose, coupler, and adapter No. 202179 not included). Wt., 17.00 lbs.
<p>NOTE: This puller may be used with any 10 ton single-acting cylinder having a 2 1/4"-14 straight collar thread.</p>		

17.5 TON CAPACITY, 2-JAW PULLER

	Order No.	Description
	PH172	2-jaw puller with RT172 center-hole Power-Twin® cylinder, cylinder half coupler, P55 pump, 6-ft. hose, hose half coupler, 1"- 8 x 20" long adjusting screw, and adjusting crank. Wt., 61.00 lbs.
	1064	Puller only. (Cylinder, pump, hose, coupler, screw, and crank not included). Wt., 22.00 lbs.

17.5 TON CAPACITY, 3-JAW PULLER

	Order No.	Description
	PH173	3-jaw puller with RT172 center-hole Power-Twin® cylinder, cylinder half coupler, P55 pump, 6-ft. hose, hose half coupler, 1"- 8 x 20" long adjusting screw, and adjusting crank. Wt., 75.00 lbs.
	PH173R	3-jaw puller with screw and crank, and RT172 center-hole twin cylinder. Wt., 56.00 lbs.
	1066	Puller only. (Cylinder, pump, hose, coupler, screw, and crank not included). Wt., 36.00 lbs.

30 TON CAPACITY, 3-JAW PULLER

	Order No.	Description
	PH303	3-jaw puller with RT302 center-hole Power-Twin® cylinder, cylinder half coupler, P55 pump, 6-ft. hose, hose half coupler, 1 1/4"- 7 x 24" large adjusting screw, and adjusting crank. Wt., 149.00 lbs.
	PH303R	3-jaw puller with screw and crank, and RT302 center-hole twin cylinder. Wt., 130.00 lbs.
	1074	Puller only. (Cylinder, pump, hose, coupler, screw, and crank not included). Wt., 90.00 lbs.

50 TON CAPACITY, 3-JAW PULLER

	Order No.	Description
	PH503	3-jaw puller with RT503 center-hole Power-Twin® cylinder, cylinder half coupler, P55 pump, 6-ft. hose, hose half coupler, 1 5/8"- 5 1/2 x 30.38" long adjusting screw, and adjusting crank. Wt., 286.00 lbs.
	1080	3-jaw puller only. (Cylinder, pump, hose, coupler, screw, and crank not included). Wt., 191.00 lbs.

Pullers

Model Shown:
PPH50

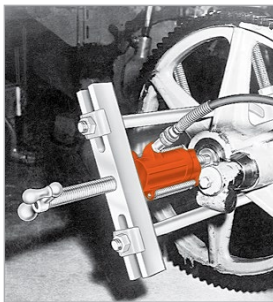
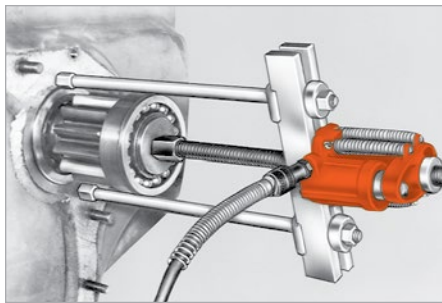

Features

THE POWER TO MAKE IMPOSSIBLE JOBS BECOME ROUTINE.

- Can apply a hydraulic pushing or pulling force, depending on how the puller is set up.
- Each unit includes perfectly matched hydraulic components that can be detached from the Bi-Directional™ Puller for other tasks requiring dependable power, and assuring maximum return on your investment.
- Optional leg kits adapt your Bi-Directional™ Puller to extra long or extra short reach.
- A wide variety of threaded adapters, bearing pulling attachments and internal pulling attachments can be used in combination with our Bi-Directional™ Pullers.



ASSEMBLING THE TOOL TO APPLY PUSHING OR PULLING FORCE:

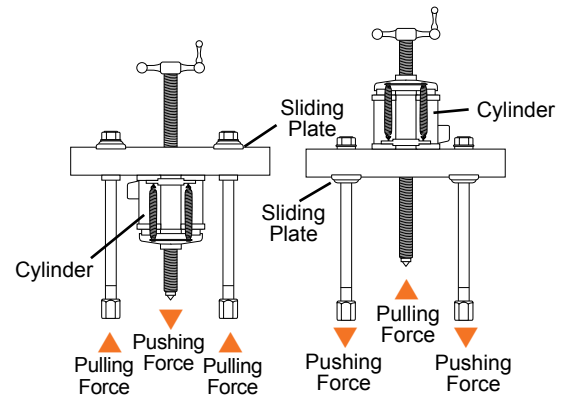

1. Determine if you want the tool's forcing screw to push or pull.
2. To exert pushing force, the forcing nut is installed beneath the cross block, as shown on left.
3. To cause the forcing screw to pull, the forcing nut is placed on top of the cross block.
4. The sliding plates must always be placed on the opposite side of the cross block from the forcing nut.

SELECTION AND CAPACITY RATING – Each Bi-Directional™ Puller's specified tonnage "capacity" is determined using its standard legs in tension. Using longer legs, or a setup in which the legs are in compression, will reduce the "capacity." Always select the largest "capacity" puller and the shortest legs that will fit the job.

POWER-TWIN® CYLINDER – This unique center-hole cylinder powers each Bi-Directional™ Puller screw runs right between the twin spring cylinder. A basic head allows you to change from a tapped hole to a plain hole by merely changing the head insert.

17.5 TON CAPACITY BI-DIRECTIONAL™ PULLER

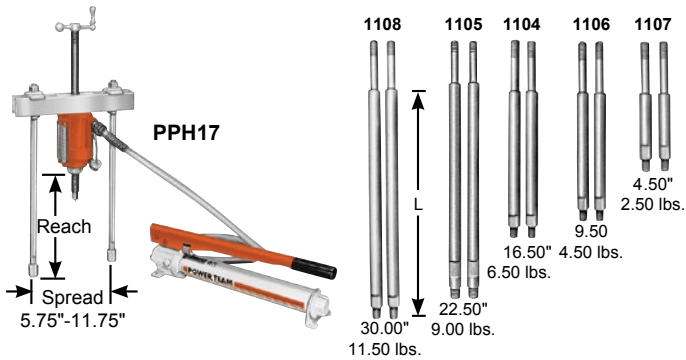

Leg Ends – Upper leg ends are threaded 3/4"-16. Lower leg ends are threaded 5/8"-18.00" long

NOTE: L = leg length: 4.50", 9.50", 16.50", 22.50", 30.00"; subtract 4.88" from leg length to determine reach when using leg end caps.

Order No.	Description
PPH17	Bi-Directional™ Puller with RT172 center-hole Power-Twin® cylinder, cylinder half coupler, P55 pump, 9767 6-ft. hose, 9798 hose half coupler, 16.50" legs, 24827 leg ends, 1"-8 x 20" large adjusting screw and adjusting crank. Wt., 59.00 lbs.
PPH17R	Bi-Directional™ Puller with RT172 center-hole Power-Twin® cylinder, cylinder half coupler, but without P55 pump, 9767 6-ft. hose and 9798 hose half coupler. Wt., 40.00 lbs.
1062	Puller only. (Cylinder, pump, hose, coupler, screw and crank not included). Wt., 20.00 lbs.

USE WITH:	
Bearing pulling attachment:	1124 and 1130.
Pully Pulling attachment:	679.
Internal Pulling attachment:	1154.
Legs:	1104, 1105, 1106, 1107 and 1108 - Pair of legs for 17.5-ton "capacity" Bi-Directional™ Puller.

30 TON CAPACITY BI-DIRECTIONAL™ PULLER

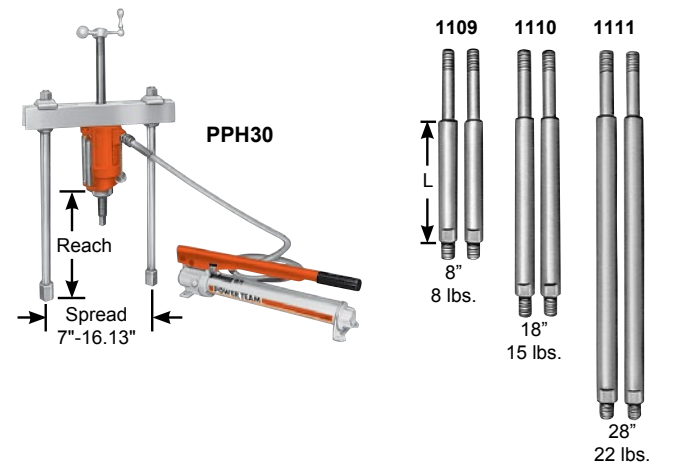

Leg Ends are threaded 1"-14 x 1.25" long

NOTE: L = leg length: 8.00", 18.00", 28.00"; subtract 5.88" from leg length to determine reach when using leg end caps.

Order No.	Description
PPH30	Bi-Directional™ Puller with RT302 center-hole Power-Twin® cylinder, cylinder half coupler, P55 pump, 9767 6-ft. hose, 9798 hose half coupler, 18" legs, 28390 leg ends, 1 1/4"-7 x 24" lg. adjusting screw and adjusting crank. Wt., 102.00 lbs.
PPH30R	Bi-Directional™ Puller with RT302 center-hole Power-Twin® cylinder, cylinder half coupler, but without P55 pump, 9767 6-ft. hose and 9798 hose half coupler. Wt., 82.00 lbs.
1070	Puller only. (Cylinder, pump, hose, coupler, screw and crank not included). Wt., 42.00 lbs.

USE WITH:	
Bearing pulling attachment:	680 (Use two 8012 adapters to connect to puller.)
Pully Pulling attachment:	679.
Internal Pulling attachment:	1166.
Legs:	1109, 1110 and 1111 - Pair of legs for 30 ton "capacity" Bi-Directional™ Puller.

50 TON CAPACITY BI-DIRECTIONAL™ PULLER

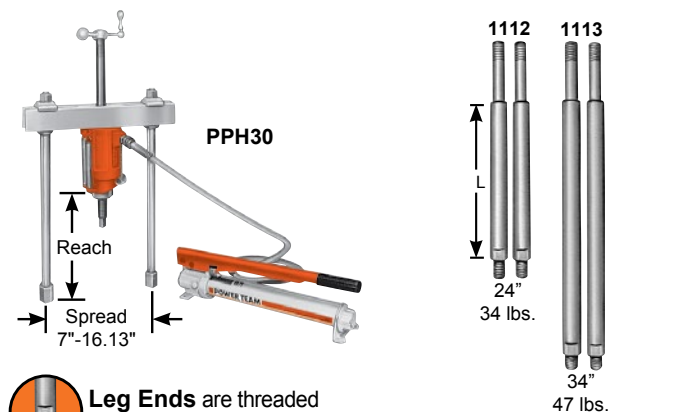

Leg Ends are threaded 1 1/4"-12 x 1.75" long

Order No.	Description
PPH50	Bi-Directional™ Puller with RT503 center-hole Power-Twin® cylinder, cylinder half coupler, P55 pump, 9767 6-ft. hose, 9798 hose half coupler, 24" legs, 1 5/8-5 1/2 x 30.38" lg. adjusting screw and adjusting crank. Wt., 201.00 lbs.
PPH50R	Bi-Directional™ Puller with RT503 center-hole Power-Twin® cylinder, cylinder half coupler, but without P55 pump, 9767 6-ft. hose and 9798 hose half coupler. Wt., 181.00 lbs.
1076	Puller only. (Cylinder, pump, hose, coupler, screw and crank not included.) Wt., 106.00 lbs.

USE WITH:	
Bearing pulling attachment:	1128.
Legs:	1112 and 1113 - Pair of legs for 50 ton "capacity" Bi-Directional™ Puller.

17.5 TON HYDRAULIC MASTER PULLER SETS

Model Shown:
IPS17



WOODEN STORAGE BOX
308435OR9 is included with the sets listed on this page.

36" L x 17.5" W x 14" D. Wt. 44 lbs.

MB5 Metal storage boxes also available.

Having this Power Team puller set at your fingertips will not only reduce your downtime, but also increase your profits.

Order No.	Description
IPS17	17.5 ton capacity puller set. Includes hydraulics, pullers, wooden storage box and accessories listed below. Wt., 191 lbs.
IPS17B	Puller set with MB5 metal box. Wt., 213.00 lbs.

HYDRAULICS	
Order No.	Description
P55	Single-stage hyd. hand. pump assembly
RT172	17.5 ton cylinder with threaded insert
9798	Hose half coupler
9767	Hydraulic hose – 6 ft.
9670	Tee adapter
9059	Pressure gauge

ACCESSORIES	
Order No.	Description
1154	Bearing cup pulling attachment
1122	Bearing pulling attachment
1123	Bearing pulling attachment
1130	Bearing pulling attachment

PULLERS	
Order No.	Description
1062	17.5 ton cap. Bi-Directional™ Puller with 16.50" legs
24814	Speed crank
32118	Adjusting screw
201923	Pushing adapter
1105	22.50" legs (2)
1066	17.5 ton 3-jaw hyd. puller
1027	Combination 2/3-jaw puller
41224	17.5 ton 2-jaw puller head
24832	Puller screw
1037	Combination 2/3-jaw puller
1041	Combination 2/3-jaw puller
28228	Cylinder cap

THREADED ADAPTERS	
Order No.	Description
679	V-belt pulley pulling attachment
8005	5/8" – 18 F. x 3/8" – 16 M. (2)
8006	5/8" – 18 F. x 1/2" – 20 M. (2)
8007	5/8" – 18 F. x 1/2" – 13 M. (2)
8010	5/8" – 18 F. x 5/8" – 11 M. (2)
8013	5/8" – 18 F. x 3/4" – 16 M. (2)
8015	5/8" – 18 F. x 3/4" – 10 M. (2)
8017	5/8" – 18 F. x 7/8" – 14 M. (2)
8018	5/8" – 18 F. x 7/8" – 9 M. (2)
8019	5/8" – 18 F. x 1" – 14 M. (2)
8020	1" – 8 F. x 5/8" – 18 M. (1)
8021	1" – 8 F. x 1" – 14 M. (1)
8044	Female threaded adapter set
8038	5/8" – 18 F. x 3/4" – 16 F. (2)
8056	Set of 6 shaft protectors (8050-8055)
1130	Set of 11 shaft protectors (8057-8067)

17.5 TON HYDRAULIC PULLER SET



This set includes a 3-jaw puller and a Bi-Directional™ Puller. Ideal for heavy-duty applications. Put this set to work wherever large gears, bearings, wheels, pulleys, etc. are found.

Order No.	Description
IPS17H	17.5 ton capacity hydraulic puller set. Includes hydraulics, pullers, wooden storage box and accessories listed below. Wt., 137.00 lbs.

HYDRAULICS	
Order No.	Description
P55	Single-stage hyd. hand. pump assembly
RT172	17.5 ton cylinder with threaded insert
9798	Hose half coupler
9767	Hydraulic hose – 6 ft.
9670	Tee adapter
9059	Pressure gauge

ACCESSORIES	
Order No.	Description
1154	Bearing cup pulling attachment
1130	Bearing pulling attachment
1105	22.50" legs (2)
24814	Speed crank
28228	Screw cap
32118	Adjusting screw
201454	Pushing adapter
41224	2-jaw head for 1066 Threaded Adapters

PULLERS	
Order No.	Description
1062	17.5 ton cap. Bi-Directional™ Puller with 16.50" legs
1066	17.5 ton 3-jaw hyd. puller

THREADED ADAPTERS	
Order No.	Description
8020	1" – 8 F. x 5/8" – 18 M. (1)
8038	5/8" – 18 F. x 3/4" – 16 F. (2)

Pullers

30 TON CAPACITY PULLER SET

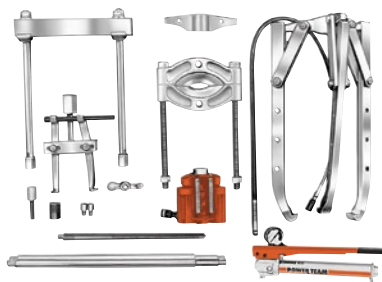

WOODEN STORAGE BOX
3084380R9 is included with the sets listed on this page.

46" L x 22.5" H x 30" D. Wt. 92 lbs.

MB16 Metal storage boxes also available.

Just what you need for those big jobs. Not only do you get a 30 ton hydraulic Bi-Directional™ Puller, you also get a 2-jaw and 3-jaw hydraulic puller. Plus, many popular accessories and the hardware to tackle the big jobs right away.

Order No.	Description
IPS30H	30 ton capacity hydraulic maintenance puller set. Includes hydraulics, pullers, wooden storage box and accessories listed below. Wt., 330 lbs.

HYDRAULICS

Order No.	Description
P55	Single-stage hyd. hand. pump assembly
RT302	30 ton cylinder with threaded insert
9798	Hose half coupler
9767	Hydraulic hose – 6 ft.
9670	Tee adapter
9059	Pressure gauge

PULLERS

Order No.	Description
1074	30 ton, 3-jaw hyd. puller
41226	2-way head for 1074
1070	30 ton cap. hydraulic Bi-Directional™ Puller with 18" legs
1111	28" legs for 1070
27198	Speed crank
28229	Screw cap
34510	Pushing adapter
34758	Adjusting screw

ACCESSORIES

Order No.	Description
8036	Female threaded adapters 1" – 14 F. x 1" – 14 F. (2)
1166	Bearing cup pulling attach.
1127	Bearing pulling attachment

50 TON CAPACITY PULLER SET

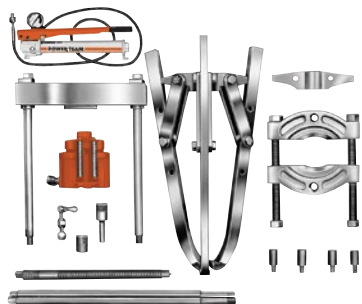

For those really big jobs, this 50 ton puller set is what you need. Just think of the jobs you can do with a 50 ton hydraulic Bi-Directional™ Puller, a 2-jaw and a 3-jaw puller, both with a 50 ton capacity. Of course, you also get many versatile accessories and attachments.

Order No.	Description
IPS50H	50 ton capacity hydraulic maintenance puller set. Includes hydraulics, pullers, wooden storage box and accessories listed below. Wt., 576.00 lbs.

HYDRAULICS

Order No.	Description
P55	Single-stage hyd. hand. pump assembly
RT503	50 ton cylinder with threaded insert
9798	Hose half coupler
9767	Hydraulic hose – 6 ft.
9670	Tee adapter
9059	Pressure gauge

PULLERS

Order No.	Description
1080	50 ton, 3-jaw hyd. puller
50449	2-way head for 1080
1076	50 ton cap. hydraulic Bi-Directional™ puller with 24" legs
1113	34" legs for 1076
29595	Speed crank
28230	Screw cap
34755	Pushing adapter
32698	Adjusting screw
1128	Bearing pulling attachment

THREADED ADAPTERS

Order No.	Description
8024	1 1/4" – 12 F. x 1 3/4" – 12 M (2)
8028	1 5/8" – 5 1/2 F. x 1" – 8 M
8029	1 5/8" – 5 1/2 F. x 1" – 14 M

Pullers

CAUTION: All the items shown may not withstand the full tonnage specified. Example: When an accessory with a 1 ton capacity is used with a 7 ton puller, the setup can be used only at a force of 1 ton.

17.5 AND 30 TON CAPACITY PULLER SETS

Model Shown:
IPS3017

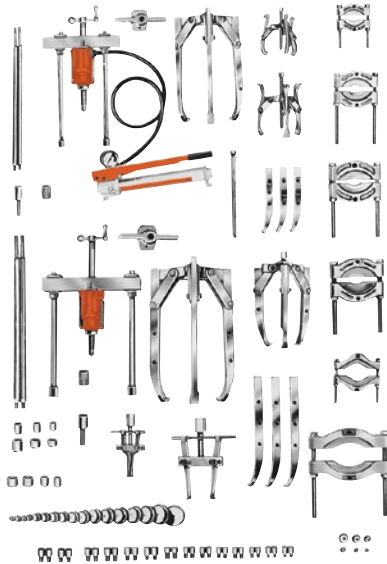

WOODEN STORAGE BOX
No. 308436OR9 is included with the sets listed on this page.

40" L x 17.5" W x 24" D. Wt. 64 lbs.

MB8 Metal storage boxes also available.

These heavy-duty maintenance sets will more than pay for themselves, especially in saving you costly damage to parts. This set lets you tackle hundreds of applications where pushing and pulling are required.

Order No.	Description
IPS3017	17.5 ton capacity puller set. Includes hydraulics, pullers, wooden storage box and accessories listed below. Wt., 191.00 lbs.
IPS3017B	Puller set with MB8 metal box. Wt., 563 lbs.

HYDRAULICS

Order No.	Description
P55	Single-stage hyd. hand. pump assembly
RT172	17.5 ton cylinder with threaded insert
RT302	30 ton center-hole twin cylinder w/ threaded insert
9798	Hose half coupler
9767	Hydraulic hose – 6 ft.
9670	Tee adapter
9059	Pressure gauge

PULLERS

Order No.	Description
1062	17.5 ton cap. Bi-Directional™ Puller with 16.50" legs
1070	30 ton cap. hydraulic Bi-Directional™ Puller with 18" legs
1066	17.5 ton 3-jaw hyd. puller
1074	30 ton 3-jaw hyd. puller
41224	17.5 ton 2-jaw puller head
41226	30 ton 2-jaw puller head
1027	Combination 2/3-jaw puller
1037	Combination 2/3-jaw puller
1041	Combination 2/3-jaw puller
43892	Long jaws (3) for 1037
30902	Long jaws (3) for 1041
1105	22.50" legs for 1062
1111	28.00" legs for 1070
24814	Speed crank
27198	Speed crank
28229	Screw cap
28228	Cylinder cap
32118	Adjusting screw
34758	Adjusting screw
34510	Pushing adapter
201923	Pushing adapter

ACCESSORIES

Order No.	Description
24832	Special puller forcing screw
8075	Step plate adapter set
8076	Step plate adapter set
8056	Shaft protector set
679	Pulley pulling attachment
680	Pulley pulling attachment
1154	Bearing cup pulling attachment
1166	Bearing cup pulling attachment
1122	Bearing pulling attachment
1123	Bearing pulling attachment
1126	Bearing pulling attachment
1130	Bearing pulling attachment

THREADED ADAPTERS

Order No.	Description
8005	5/8" – 18 F. x 3/8" – 16 M. (2)
8006	5/8" – 18 F. x 1/2" – 20 M. (2)
8007	5/8" – 18 F. x 1/2" – 13 M. (2)
8010	5/8" – 18 F. x 5/8" – 11 M. (2)
8012	1" – 14 F. x 5/8" – 18 M. (2)
8013	5/8" – 18 F. x 3/4" – 16 M. (2)
8015	5/8" – 18 F. x 3/4" – 10 M. (2)
8017	5/8" – 18 F. x 7/8" – 14 M. (2)
8018	5/8" – 18 F. x 7/8" – 9 M. (2)
8019	5/8" – 18 F. x 1" – 14 M. (2)
8020	1" – 8 F. x 5/8" – 18 M. (1)
8021	1" – 8 F. x 1" – 14 M. (1)
8025	1 1/4" – 7 F. x 5/8" – 18 M. (2)
8027	1 1/4" – 7 F. x 1" – 14 M. (2)
8036	1" – 14 F. x 1" – 14 F. (2)
8038	5/8" – 18 F. x 3/4" – 16 F. (2)
8044	Female threaded adapter set

Pullers

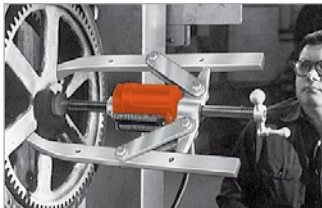

2-jaw puller reaches through spokes of gear to grip hub. Hand pump supplies hydraulic power.



Flexible coupler is removed from electric motor shaft with 2-jaw puller.

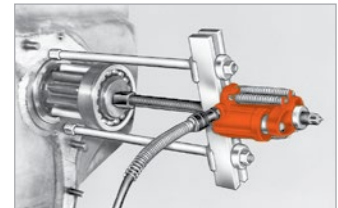

Typical setup for removing sprocket drive pinion shaft. Puller screw is attached to shaft by threaded adapter. Shaft is now ready to be pulled out hydraulically.

CAUTION: All the items shown may not withstand the full tonnage specified. Example: When an accessory with a 1 ton capacity is used with a 7 ton puller, the setup can be used only at a force of 1 ton.

17.5 AND 50 TON CAPACITY PULLER SETS

Model Shown:
IPS5017

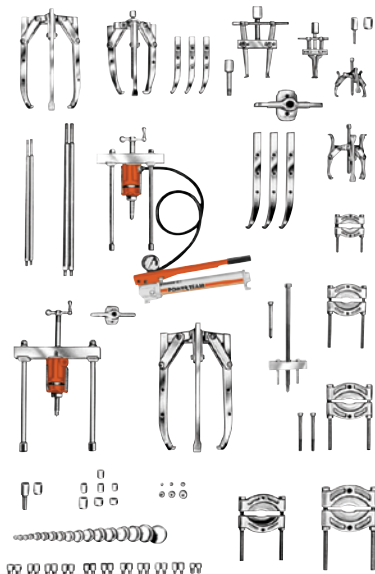

WOODEN STORAGE BOX
No. 3084390R9 is included with the sets listed on this page.

46" L x 22.5" W x 30" D. Wt. 105 lbs.

MB16 Metal storage boxes also available.

If you are looking for a maintenance puller set that will handle a wide variety of applications, this one is for you. The mechanical and hydraulic pullers and attachments are designed to handle most removing and installing jobs with a minimal amount of effort.

Order No.	Description
IPS5017	17.5 and 50 ton capacity manual and hydraulic puller set. Includes hydraulics, pullers, wooden storage box and accessories listed below. Wt., 892.00 lbs.
IPS5017B	Puller set with MB16 metal box. Wt., 915.00 lbs.

HYDRAULICS

Order No.	Description
P55	Single-stage hyd. hand. pump assembly
RT172	17.5 ton cylinder with threaded insert
RT503	50 ton center-hole twin cylinder w/ threaded insert
9798	Hose half coupler
9767	Hydraulic hose – 6 ft.
9670	Tee adapter
9059	Pressure gauge

PULLERS

Order No.	Description
1062	17.5 ton cap. Bi-Directional™ Puller with 16.50" legs
1076	50 ton cap. hydraulic Bi-Directional™ Puller with 24.00" legs
1066	17.5 ton 3-jaw hyd. puller
1080	17.5 ton 3-jaw hyd. puller
41224	17.5 ton 2-jaw puller head
50449	50 ton 2-jaw puller head
1027	Combination 2/3-jaw puller
1037	Combination 2/3-jaw puller
1041	Combination 2/3-jaw puller
43892	Long jaws (3) for 1037
30902	Long jaws (3) for 1041
1105	22.50" legs for 1062
1113	34.00" legs for 1076
24814	Speed crank
29595	Speed crank
28228	Screw cap
28230	Cylinder cap
32118	Adjusting screw
32698	Adjusting screw
34755	Pushing adapter
201923	Pushing adapter
7392	Gear and pulley puller
24833	Forcing screw for 7392

ACCESSORIES

Order No.	Description
8075	Step plate adapter set
8076	Step plate adapter set
8056	Shaft protector set
1154	Bearing cup pulling attachment
1166	Bearing cup pulling attachment
1122	Bearing pulling attachment
1123	Bearing pulling attachment
1126	Bearing pulling attachment
1127	Bearing pulling attachment
1130	Bearing pulling attachment
34479	Reducing adapter for 1166
10215	Hex nut; 3/4" – 16 (2)
24829	Short bolt

THREADED ADAPTERS

Order No.	Description
8005	5/8" – 18 F. x 3/8" – 16 M. (2)
8006	5/8" – 18 F. x 1/2" – 20 M. (2)
8007	5/8" – 18 F. x 1/2" – 13 M. (2)
8010	5/8" – 18 F. x 5/8" – 11 M. (2)
8013	5/8" – 18 F. x 3/4" – 16 M. (2)
8015	5/8" – 18 F. x 3/4" – 10 M. (2)
8019	5/8" – 18 F. x 1" – 14 M. (2)
8020	1" – 8 F. x 5/8" – 18 M. (1)
8021	1" – 8 F. x 1" – 14 M. (1)
8023	1 1/4" – 12 F. x 1" – 14 M. (2)
8028	1 5/8" – 5 1/2 F. x 1" – 8 M. (1)
8029	1 5/8" – 5 1/2 F. x 1" – 14 M. (1)
8038	5/8" – 18 F. x 3/4" – 16 F. (2)
8044	Female threaded adapter set

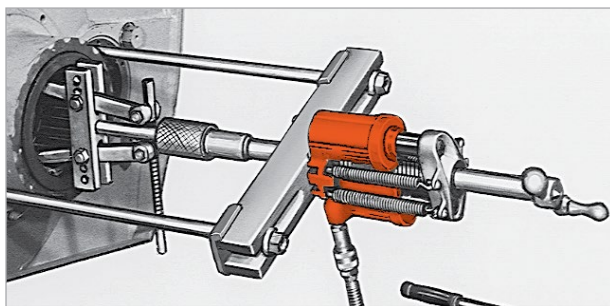

Combination of 50 ton capacity Bi-Directional™ Puller and cup pulling attachment simplifies the removal of a final drive axle seal.

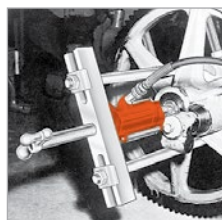

Hydraulically powered Bi-Directional™ Puller removes drive wheel. Pulling attachment is used to provide gripping surface.

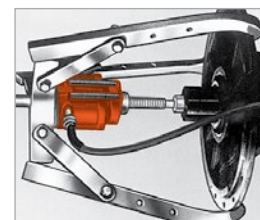

3-jaw puller provides grip while hydraulic hand pump provides power to push shaft from housing. Shaft protector is used on end of puller screw.

Pullers

CAUTION: All the items shown may not withstand the full tonnage specified. Example: When an accessory with a 1 ton capacity is used with a 7 ton puller, the setup can be used only at a force of 1 ton.

17.5, 30 AND 50 TON CAPACITY PULLER SETS

Model Shown:
IPS5317

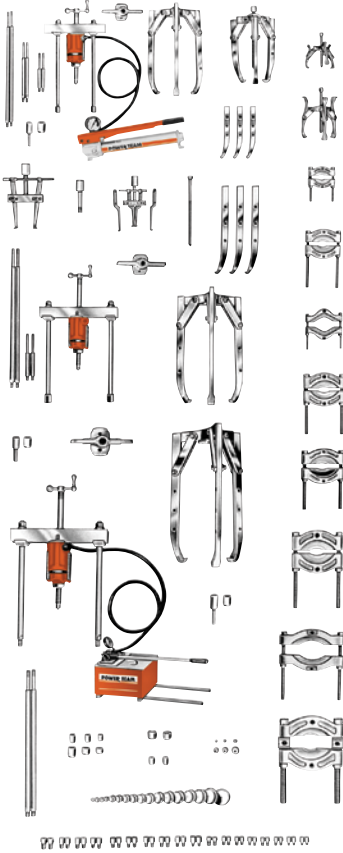

WOODEN STORAGE BOX
No. 308440OR9 is included with the sets listed on this page.

46.5" L x 22.5" W x 36" D. Wt. 120 lbs.

MB16 Metal storage boxes also available.

Pullers

Here's the ultimate in industrial puller sets! You'll find a puller for just about every job. Included in this "master set" are 17.5, 30 and 50 ton hydraulics, along with an extensive assortment of pullers, attachments and adapters.

Order No.	Description
IPS5317	17.5, 30 and 50 ton capacity manual and hydraulic puller set. Includes hydraulics, pullers, wooden storage box and accessories listed below. Wt., 1260.00 lbs.

HYDRAULICS	
Order No.	Description
P55	Single-stage hyd. hand. pump assembly
P460	Two-stage hyd. hand pump w/3-way control valve
RT172	17.5 ton center-hole twin cylinder w/threaded insert
RT302	30 ton center-hole twin cylinder w/threaded insert
RT503	50 ton center-hole twin cylinder w/threaded insert
9798	Hose half coupler (2)
9767	Hydraulic hose – 6 ft. (2)
9670	Tee adapter
9059	Pressure gauge

PULLERS	
Order No.	Description
1062	17.5 ton cap. Bi-Directional™ Puller w/16.50" legs
1070	30 ton cap. Bi-Directional™ Puller with 18" legs
1076	50 ton cap. Bi-Directional™ Puller with 24" legs
1066	17.5 ton 3-jaw hyd. puller
1074	30 ton 3-jaw hyd. puller
1080	50 ton 3-jaw hyd. puller
41224	17.5 ton 2-jaw puller head
41226	30 ton 2-jaw puller head
50449	50 ton 2-jaw puller head
1027	Combination 2/3-jaw puller
1037	Combination 2/3-jaw puller
1041	Combination 2/3-jaw puller
43892	Long jaws (3) for 1037
30902	Long jaws (3) for 1041
32136	Long jaws (2) for 1154
1105	22.50" legs for 1062
1106	9.50" legs for 1062
1107	4.50" legs for 1062
1109	8.00" legs for 1070
1111	28.00" legs for 1070
1113	34.00" legs for 1070

ACCESSORIES	
Order No.	Description
24832	Special puller forcing screw
24814	Speed crank
27198	Speed crank
29595	Speed crank
28228	Screw cap
201923	Pushing adapter
28229	Screw cap
28230	Screw cap

ACCESSORIES	
Order No.	Description
32118	Adjusting screw
32698	Adjusting screw
34758	Adjusting screw
34510	Pushing adapter
34755	Pushing adapter
201923	Pushing adapter
8075	Step plate adapter set
8076	Step plate adapter set
8056	Shaft protector set
679	Pulley pulling attachment
680	Pulley pulling attachment
1154	Bearing cup pulling attachment
1166	Bearing cup pulling attachment
1122	Bearing pulling attachment
1123	Bearing pulling attachment
1126	Bearing pulling attachment
1127	Bearing pulling attachment
1128	Bearing pulling attachment
1130	Bearing pulling attachment
34479	Reducing adapter

THREADED ADAPTERS	
Order No.	Description
8005	5/8" – 18 F. x 3/8" – 16 M. (2)
8006	5/8" – 18 F. x 1/2" – 20 M. (2)
8007	5/8" – 18 F. x 1/2" – 13 M. (2)
8010	5/8" – 18 F. x 5/8" – 11 M. (2)
8012	1" – 14 F. x 5/8" – 18 M. (2)
8013	5/8" – 18 F. x 3/4" – 16 M. (2)
8015	5/8" – 18 F. x 3/4" – 10 M. (2)
8017	5/8" – 18 F. x 7/8" – 14 M. (2)
8018	5/8" – 18 F. x 7/8" – 9 M. (2)
8019	5/8" – 18 F. x 1" – 14 M. (2)
8020	1" – 8 F. x 5/8" – 18 M. (1)
8021	1" – 8 F. x 1" – 14 M. (1)
8023	1 1/4" – 12 F. x 1" – 14 M. (2)
8024	1 1/4" – 12 F. x 1 3/4" – 12 M. (2)
8025	1 1/4" – 7 F. x 5/8" – 18 M. (2)
8027	1 1/4" – 7 F. x 1" – 14 M. (2)
8028	1 5/8" – 5 1/2 F. x 1" – 8 M. (1)
8029	1 5/8" – 5 1/2 F. x 1" – 14 M. (1)
8036	1" – 14 F. x 1" – 14 F. (2)
8038	5/8" – 18 F. x 3/4" – 16 F. (2)
8044	Female threaded adapter set

CAUTION: All the items shown may not withstand the full tonnage specified. Example: When an accessory with a 1 ton capacity is used with a 7 ton puller, the setup can be used only at a force of 1 ton.

Model Shown:
PHP8H, PHP8R

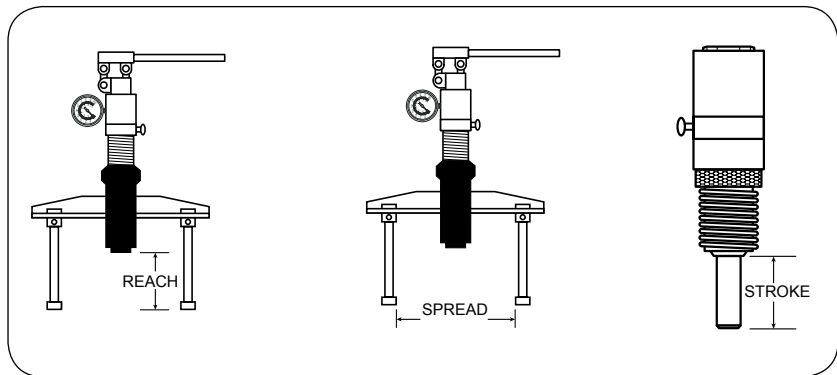
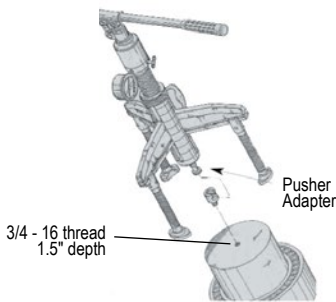

Ordering Information

Order No.	Description	Cylinder Cap. (ton)	Reach (in.)	Spread (in.)	Stroke (in.)	Weight with Case (lbs.)
PHP8H	Manual-Hydraulic Pusher	8	2.16 - 15.16	2.28 - 10.62	3.23	74.00
PHP8R	Remote Hydraulic Pusher	8	2.16 - 15.16	2.28 - 10.62	3.23	77.30
PHP8H-1	Manual-Hydraulic	8	2.16 - 15.16	2.28 - 10.62	3.23	117.00
PHP8R-1	Remote Hydraulic Pusher/Puller Kit	8	2.16 - 15.16	2.28 - 10.62	3.23	114.00

IMPORTANT SAFETY INFORMATION: Power Team recommends the use of protective blankets for all pushing operations. For ease of visual clarity, we have shown the pusher application photos without these safeguards.

Features

IDEAL FOR INSTALLING A WIDE VARIETY OF PRESS-FIT PARTS.

- Power Team pushers have been rigorously tested for top performance and reliability at maximum capacity.
- These pushing systems are covered by Power Team's exclusive PowerThon™ Limited Lifetime Warranty — assuring you of the highest quality and reliability.

BEARING PUSHER KITS

- Portable pushing kits include an external Lock-Jaw™ puller, an internal puller, hydraulic cylinder, and a tri-section pulling attachment, all in one compact, lightweight unit complete with carrying case.

Model Shown:
PH553C

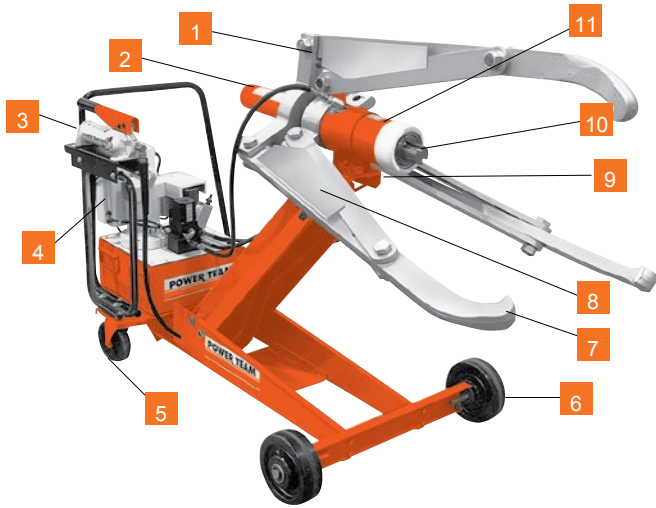

Features

ENFORCER 55

- 1 Puller can be assembled in 2 or 3-jaw configurations.
- 2 Hydraulically-actuated jaws allows cylinder to move in or out with a safe, secure grip on workpiece.
- 3 Hydraulic lift system for easy, precise position of puller.
- 4 Unique dual pump arrangement. Low pressure pump positions, holds and opens jaws. The high pressure pump advances and retracts the pushing cylinder without releasing clamped jaws.
- 5 Swivel casters give ease of mobility.
- 6 Large wheels make movement of cart easy.
- 7 Super Lock-Jaw™ feature means the harder the pull, the tighter the puller jaws grip. No chains or cages required to keep puller jaws from slipping or springing off the part being pulled.
- 8 Guards at pinch points protect operator.
- 9 Puller can be mounted on cart 90 degrees to right or left of puller cart centerline, permitting use in tight quarters, such as between machinery.
- 10 Self-centering design puller jaws will automatically grip work evenly.
- 11 Choice of cylinder with a 6.25" or 13.25" stroke.



PUSHING ADAPTERS

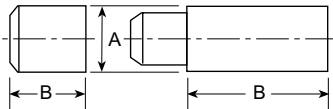

Order No.	Qty. *	A (in.)	B (in.)
251002	1	2.75	2.75
350593 **	2	2.75	6.00
350594	1	2.75	3.00
350637	1	2.75	10.00

* Number of adapters supplied with each Enforcer.

** Only 1 for units with 13.25" stroke.



CONVERSION KIT

Conversion Kit No. 251468. Kit converts PH553C series to PH553CL series. Jaws are 12" longer. Kit contains three jaws and six straps with guards. Wt., 250.00 lbs.



Note: Four cylinder extensions (not pictured) are included. The included lifting eyes (not pictured) permit use of an overhead crane to raise entire assembly.

IMPORTANT SAFETY INFORMATION: Power Team recommends the use of protective blankets for all pushing operations. For ease of visual clarity, we have shown the pusher application photos without these safeguards.

Ordering Information

Order No.	Puller Jaw Tip			Min. Spread (in.)	Reach Min. Spread (in.)	Max. Spread (in.)	Reach Max. Spread (in.)	Overall Length * (in.)	Cyl. Stroke (in.)	Power Source Requirements (in.)	Prod. Wt. (lbs.)
	A (in.)	B (in.)	C (in.)								
PH553C	0.88	1.25	1.88	4.00	22.00	48.00	14.00	90.00	6.25	115 V, 60Hz, 25 Amp Cap.	749.00
PH553C13				4.00	15.00	48.00	7.00	90.00	13.25	115V, 60Hz, 25 Amp Cap.	776.00
PH553CL				2.50	25.63	45.25	22.00	102.00	13.25	115V, 60Hz, 25 Amp Cap.	836.00
PH553C-230				4.00	22.00	48.00	14.00	90.00	6.25	230V, 50/60Hz, 15 Amp Cap.	749.00
PH553C13-230				4.00	15.00	48.00	7.00	90.00	13.25	230V, 50/60Hz, 15 Amp Cap.	776.00
PH553CL-230				2.50	32.63	45.25	29.00	102.00	6.25	230V, 50/60Hz, 15 Amp Cap.	809.00
PH553CL13-230				2.50	25.63	45.25	22.00	102.00	13.25	230V, 50/60Hz, 15 Amp Cap.	836.00

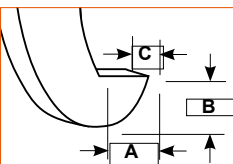

* Cart and Puller (cart width = 32.00")

Model Shown:
PH1002

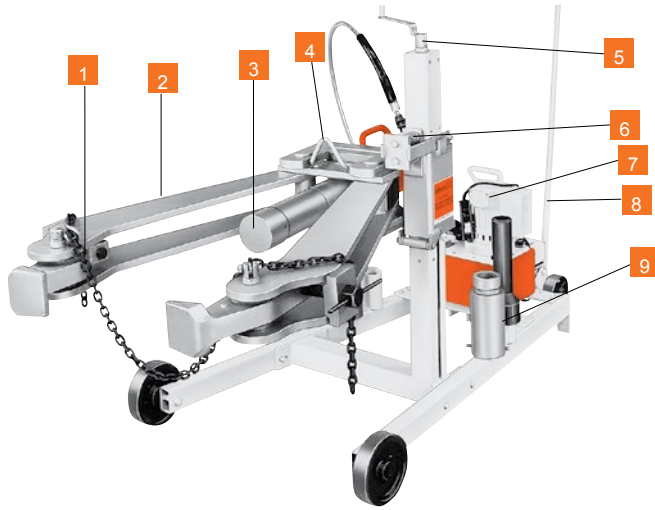

Features

ENFORCER 100

- 1 Adjustable jaws mean they always pull on a flat surface. Retaining chain holds jaws in place during positioning.
- 2 Lock-Jaw™ feature means jaws grip progressively tighter as more pulling force is applied.
- 3 100 ton hydraulic cylinder is single-acting, spring return type with a maximum working pressure of 10,000 psi.
- 4 Lifting bracket allows puller to be lifted if the workpiece center is more than 36" off the floor.
- 5 Adjusting screw allows operator to move vertical position of the puller.
- 6 Spring loaded feature means Enforcer 100 will align itself on uneven pulls.
- 7 Hydraulic pump is a 2-stage, high pressure unit controlled by remote hand switch with 25 foot cord.
- 8 Tow bar provides puller with plenty of mobility.
- 9 Pushing adapters have a diameter of 4.13" and 2.50".



An ideal puller for steel mills, mines, oil fields, utility projects, paper mills, construction sites, railroads, airline shops, shipyards or anywhere else where large equipment and machinery pose tough maintenance challenges.

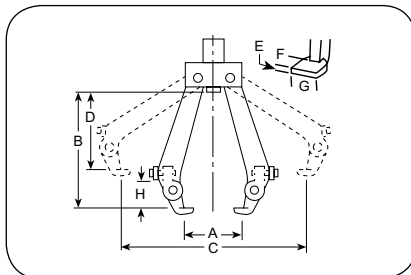

Ordering Information

Order No.	Min. Spread	Reach Min. Spread	Max. Spread	Reach Max. Spread	Puller Jaw Tip			Max. Thick. Workpiece	Vertical Stroke Adjust.	Overall Length	Max. Thickness Workpiece	Wheel Dia.	Power Source Requirements
	A	B	C	D	E	F	G						
	(in.)	(in.)	(in.)	(in.)	(in.)	(in.)	(in.)						
PH553C PH553C13	15.00	42.00	48.00	34.00	1.00	2.25	5.00	10.25	12 - 36	94	12	8	115VAC, 50/60Hz, 25 Amp Cap.

RAM EXTENSIONS

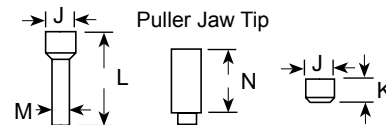

Order No.	Adapter Type	Amount included w/puller	J	K	L	M	N
			(in.)	(in.)	(in.)	(in.)	(in.)
251002	Push	1	4.13	—	13.50	2.50	—
350594	Ext.	4	4.13	—	—	—	8.00
350637	Push	1	4.13	3.50	—	—	—

“ENFORCER 100” UNIVERSAL PULLER

Order No.	Description
PH1002	100 ton, 2-jaw universal hydraulic puller. Includes: 2-jaw Lock-Jaw™ puller, PE552S 2-speed electric/hydraulic power unit, C10010C 100 ton hydraulic cylinder with 10.25" stroke and six adapters. Wt., 890 lbs.
PH1002J	100 ton, 2-jaw universal hydraulic puller. Includes: 2-jaw Lock-Jaw™ puller, but without hydraulic power unit., C10010C 100 ton hydraulic cylinder with 10.25" stroke and six adapters. Wt., 825 lbs.
PE552S	Pump only. 1 1/8 hp, 115VAC, 50/60Hz, single-phase, draws 25 amps at full load. Also available in 220VAC, 50Hz.

NOTE: For 220VAC, 50 Hz applications, order puller's Part No. PH1002-220

Model Shown:
PR3100J, PR3100S



Our roller bearing pullers are ideal for replacing tough, worn-out bearings on RR freight cars.

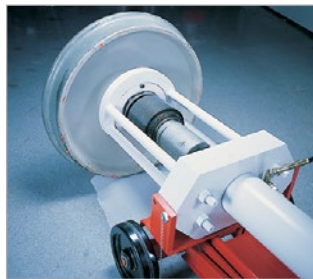

The photo above shows the Universal Puller in position on the roller bearing assembly, which is ready for removal.

Features

UNIVERSAL RAILROAD AXLE JOURNAL ROLLER BEARING PULLER/INSTALLER.

- Quickly remove or install tapered roller bearings.
- With both sling and jack models available and two pumps to choose from, you can tailor the unit to match your needs.
- The industry standard in most wheel shops.
- Each unit will service a full line of bearings with rotating end caps, from class B thru GG.
- Designed with the cooperation of major bearing manufacturers.
- Fast, simple, one-person operation with 100-tons of pulling force provided.
- Completely portable for easy, convenient positioning and out-of-the-way storage.
- Each unit complete with a heavy-duty 100-ton hydraulic cylinder, 10,000 PSI pump with remote control solenoid valve, hydraulic pressure gauge (11543), a pulling shoe and installing tube.
- CSA certified (LR19814)



PROTECTIVE BLANKETS



Power Team has protective blankets available which may afford protection from injury to users and others should part breakage occur.

For more information, see page 242.



CAUTION

Power Team recommends the use of these blankets for all pushing, pulling, pressing, and lifting applications.

Ordering Information

Order No.	Model Type	Cylinder Type	Valve Type	H.P.	Pump Information Phase	Voltage
PR2100J †	Jack	Double-Acting	Solenoid	2 **	1	115VAC or 230VAC *
PR3100J †	Jack	Double-Acting	Solenoid	3	3	230VAC or 460VAC *
PR2100S †	Sling	Double-Acting	Solenoid	2	1	115VAC or 230VAC *
PR3100S †	Sling	Double-Acting	Solenoid	3	3	230VAC or 460VAC *

* Prewired at factory for these voltages. Other voltages available upon request.

** The 2 hp, 115VAC requires 30 amp service.

† Equipped with hydraulic pressure gauge 11543.

▶ Tooling Ordering Information

IMPORTANT: This tooling chart applies only to standard AAR configurations for freight car applications. In order to provide adapters needed to service housing-type locomotive and passenger car bearings, as well as metric bearings, Power Team must be provided with the following information. Bearing manufacturer's name and general arrangement drawing number, size of bearing to be serviced, railroad name and location and part numbers of adapters already in your possession if you currently own a Puller/Installer.

Tool Description	Class and size of bearing assembly - TBU & SP "Metric Tooling"			
	120	130	140	150
Pulling Shoe, Insert Adapter	351830	30512	30521	30520
Guide Tube & Cap Screw Assy.	253341	253342	253343	253344
Cap Screw *	253339	253394	253339	253395
Guide Tube Adapter	212247	21247	21247	21247
Installing Tube Adapter Ring	253335	253336	253337	253338

* Screws are supplied with the guide tube and should be ordered as replacements only.

Tool Description	Class and size of bearing assembly to be serviced									
	Class B 4.25" x 8"	Class C 5" x 9"	Class D 5.50" x 10"	Class E 6" x 11"	Class EE 5.50" Axle	Class EE 6" Axle	Class F 6.50" x 12"	Class G 7" x 12"	Class G 6.50" Axle	Class GG 6.50" Axle
Pulling Shoe	420845 is included as part of basic machine					Do No Order	420846	420846	420846	420846
Pulling Shoe, Insert Adapter	30522	30512	30521	30520	30520	30519	30519	—	—	—
Guide Tube & Cap Screw Assy.	253313	253314	253317	253318	253316	253327	253320	253321	253319	253323
Cap Screw *	253156	253349	253308	253155	253307	253308	253310	253326	253309	253309
Guide Tube, No Adapter	23934	21248	21248	21247	21247	21247	21247	21247	21247	21247
Installing Tube	30416 is included as part of basic machine					Do No Order	30417	30417	30417	30417
Installing Tube Adapter Ring	21242	21258	21256-1	21255-1	21255-1	21257-1	21257-1	30586	30585	30585

* Screws are supplied with the guide tube and should be ordered as replacements only.

NOTE: Adapters listed above are for servicing the following roller bearing assemblies: Brenco "Crown-Taper", New Departure-Hyatt "Hy-Roll Taper", SKF "Expediter" and Timken "AP".

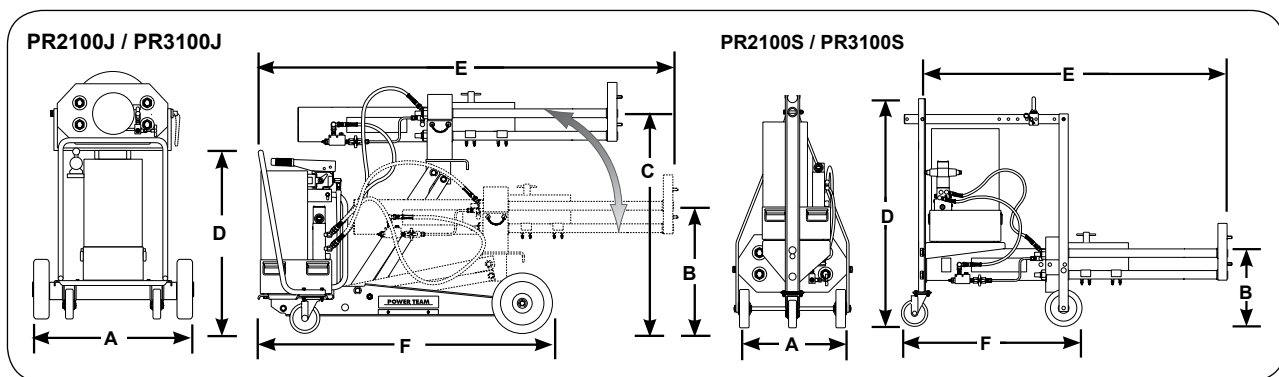

▶ Technical Dimensions

Order No.	A	B	C	D	E	F	Stroke (in.)	Capacity		Advance (in./min.)	Speed		Weight (lbs.)
	(in.)	(in.)	(in.)	(in.)	(in.)	(in.)		Pull (tons)	Inst. (tons)		Pull (in./min.)	Inst. (in./min.)	
PR2100J	32.00	15.06	41.69	36.91	78.00	58.75	4.00	22.00	48.00	14.00	90.00	6.25	749.00
PR3100J	32.00	15.06	41.69	36.91	78.00	58.75	4.00	15.00	48.00	7.00	90.00	13.25	776.00
PR2100S	24.38	11.00	—	50.50	64.25	38.75	2.50	25.63	45.25	22.00	102.00	13.25	836.00
PR3100S	24.38	11.00	—	50.50	64.25	38.75	4.00	22.00	48.00	14.00	90.00	6.25	749.00

UNIVERSAL BEARING CUP INSTALLER



This installer adjusts to fit bearing cups from 3.63" - 6.50" O.D. It replaces over two dozen plates and drivers. Simply adjust the jaws to fit the cup I.D., lock the jaws, slip the new cup on and drive it home with a hammer.

Order No.	Description
7180	Universal bearing cup installer. Wt., 10 lbs.

ASSEMBLE YOUR OWN "CUSTOM-MADE" DRIVER TOOLS



These sets include discs and handles for custom seal driver assembly to provide a pilot (to prevent cocking), a spacer (so force is applied on the proper area) and a driver (for even force dist.). Discs range from 0.50" thru 4.50" diameters in 0.06" increments. Each set includes a handy plastic box with pre-cut tool tray.

Order No.	Description
27793	STARTER SET. Contains handle and discs especially selected to provide the driver sizes most frequently needed. Maximum utility at a modest investment! Wt., 4.00 lbs.

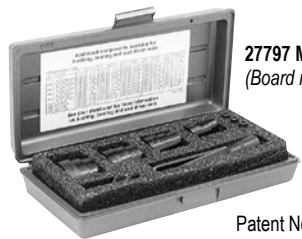

27797 Master Set
(Board not included)

Patent No. 4,429,447

Order No.	Description
27794	BASIC SET. Wide coverage, low investment! Includes 41 discs and two handles. Size range: 0.50" - 3.00" diameter. Wt., 22.00 lbs.
27795	BIG JOB SET. Used for servicing large components. You get coverage of 3.06" thru 4.50" diameter with the 24 discs and handle provided. Wt., 45.00 lbs.
27797	MASTER SET. For maximum coverage. Three handle sizes and all 65 discs listed in chart below are included. Range: 0.5" thru 4.50" diameter. Wt., 68.00 lbs.
212377	TOOL ORGANIZER BOARD. Will accommodate all components of 27797 Master Set. Tools not included. Wt., 5.00 lbs.

DISCS

Order No.	Discs (in.)	Order No.	Discs (in.)	Order No.	Discs (in.)
27491	0.50	27512	1.81	27534	3.19
27492	0.56	27513 †	1.88	27535	3.25
27493 †	0.63	27514	1.94	27536	3.31
27494	0.69	27515	2.00	27537	3.38
27495 †	0.75	27516	2.06	27538	3.44
27496	0.81	27517	2.13	27539	3.50
27497 †	0.88	27518	2.19	27540	3.56
27498	0.94	27519	2.25	27541	3.63
27499 †	1.00	27520	2.31	27542	3.69
27500	1.06	27521	2.38	27543	3.75
27501 †	1.13	27522	2.44	27544	3.81
27502	1.19	27523	2.50	27545	3.88
27503 †	1.25	27524	2.56	27546	3.94
27504	1.31	27525	2.63	27547	4.00
27505 †	1.38	27526	2.69	27548	4.06
27506	1.44	27527	2.75	27549	4.13
27507 †	1.50	27528	2.81	27550	4.19
27508	1.56	27529	2.88	27551	4.25
27509 †	1.63	27530	2.94	27552	4.31
27510	1.69	27531	3.00	27553	4.38
27511 †	1.75	27532	3.06	27554	4.44
		27533	3.13	27555	4.50

† Items contained in 27793 starter set.

SET COMPONENTS

Order No.	Description
10012 †	1/4"-20 UNC X 0.88" *
10020 †	1/4"-20 UNC X 1.25" *
10854 †	1/4"-20 UNC X 1.75"
10855 †	1/4"-20 UNC X 2.75" *
12001 †	1/4"-20 UNC X 2.25" *
27487 †	Small Handle 5" X 3/4" Dia.
27488	Med. Handle 6" X 1-1/4" Dia.
27489	Large Handle 6" X 1-5/8" Dia.
27490	Extension Tube
7350 †	Allen Wrench

* Socket head cap screw.



Pullers

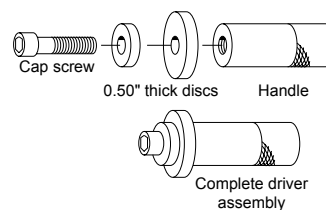

These sets have the proper-size driver for any seal, bearing or bushing installing job. Select the proper-size discs, attach to handle with cap screws and strike with hammer.

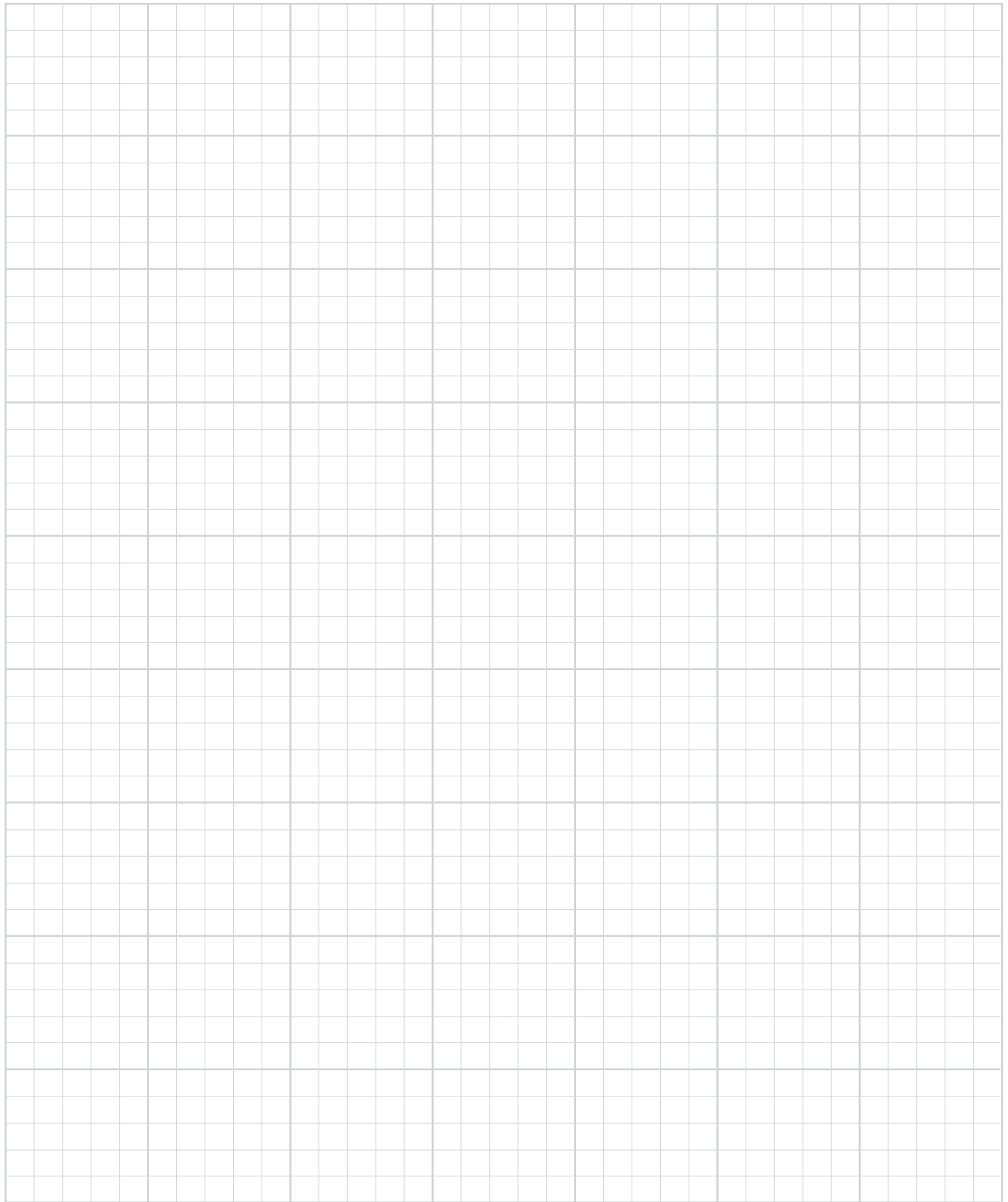

RESOURCES

GET INFORMED AND LEARN MORE ABOUT POWER TEAM PRODUCTS IN OUR RESOURCE SECTION







Power Team brings expertise to your application challenges in a variety of industries worldwide.

Within your resource section, you will have a variety of tools availability to select and capture information working around our products.

Power Team is a brand of SPX FLOW Inc., a global, Fortune 500, multi-industry company based in the United States in Charlotte, North Carolina. The company maintains operations in more than 35 countries, bringing to market solutions that benefit society while delivering value-added, bottom-line results to customers across three broad-based categories: power and energy, food and beverage and industrial processes. SPX FLOW Inc. is traded on the New York Stock Exchange.



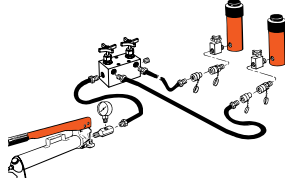
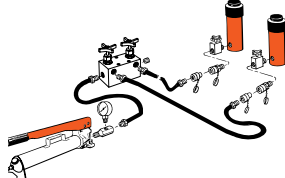
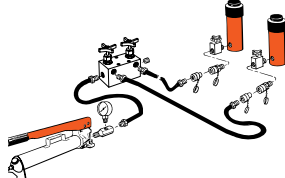
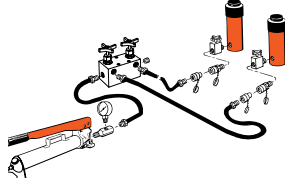

	Section	Page(s)
 	Manufacturing Standards	267
	Warranty Overview	268
	Hydraulic Safety Insights	269-270
	Application Insights	271-272
	Hydraulic Circuits	273-274
	Formula Conversions	275-276
	System Arrangement Workbook	277-278
	Cylinder Seal Kit Reference Table	279-280
	Notes	281

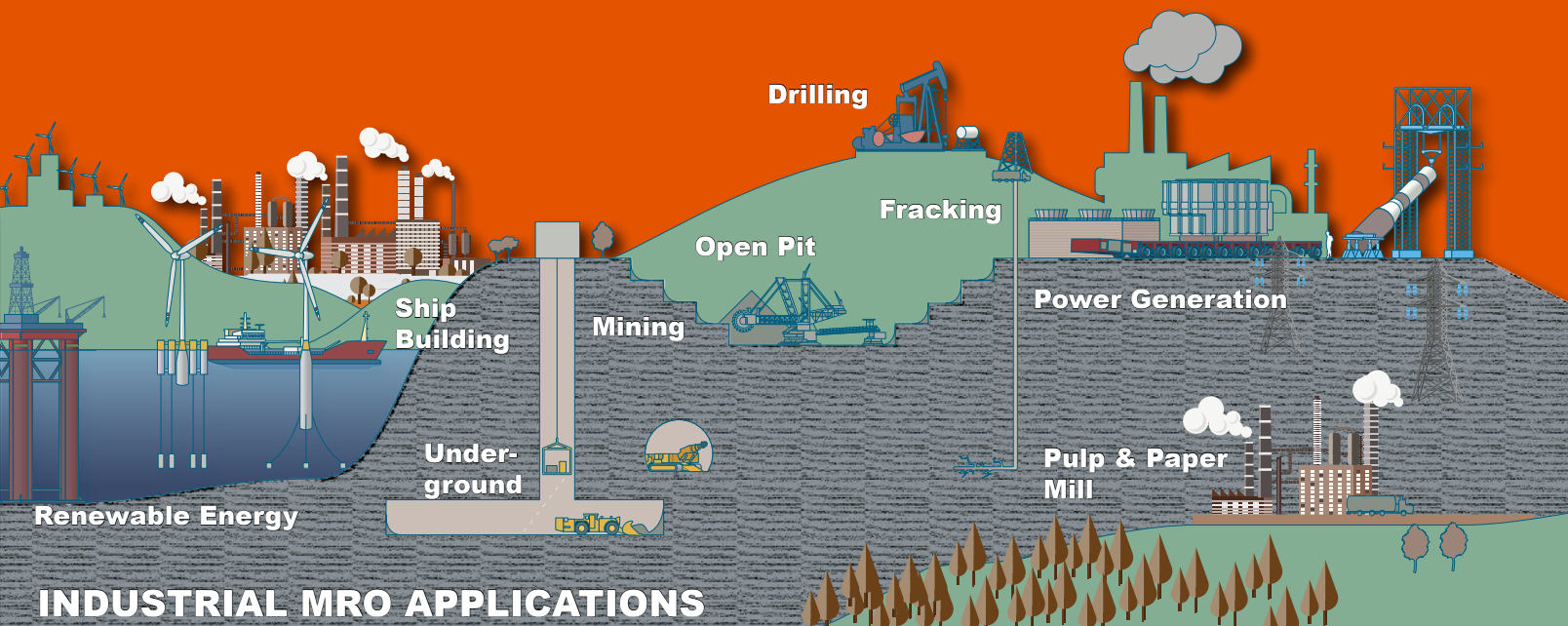



The SPX FLOW commitment to quality, through our Power Team brand, is evident in everything we do. From raw material receipt to how we support our customers years after they purchase our products. The Power Team brand is registered to ISO 9001 international quality standard, which requires compliance with standards for management, administration, product development, manufacturing and continuous improvement. Our registration verifies that the SPX FLOW has adopted and maintains documentation for processes ranging from suppliers to customers, inspection, handling and training. ISO 9001 also requires periodic internal and external audits to ensure all aspects of work affecting quality control are monitored.

ASME B30.1

Power Team hydraulic cylinders comply with the criteria set forth in the American Society of Mechanical Engineers standard ASME B30.1: Cylinders are tested at 125 percent of rated pressure at full travel and are inspected to assure functionality and freedom from leaks.

ASME B40.1

Power Team heavy-duty pressure gauges are designed in accordance with the recommendations set forth in the American Society of Mechanical Engineers standard ASME B40.1, Grade B.

CE Mark

SPX FLOW is committed to designing, manufacturing and marketing products that meet or exceed the needs of the customers we serve. Power Team supplies a Declaration of Incorporation (for Partly Completed Machinery only) or a Declaration of Conformity and CE Marking for products that are within the scope and conform to at least one European Community CE Directive. Note: Not all products are within such scope and subsequently may not be allowed to carry a CE mark. If the CE mark is required or requested, please contact the factory for clarification and note that it must be requested at the time a product is ordered.

CSA

Where specified in our literature and catalogs and on our web site, Power Team electric power pump assemblies meet the design, assembly and test requirements of the Canadian Standards Association. Note: If CSA certification is required, it must be requested at the time a Power Team pump is ordered.

IJ100

Power Team hoses meet the criteria set forth in the Material Handling Institutes specification #IJ100 for hydraulic hose. Under the procedures outlined in this standard, hydraulic hose shall:

- Have an average minimum life of 30,000 cycles at full rated capacity.
- Have a minimum burst pressure of at least twice the rated operating pressure.

NEMA

Where specified in our literature and catalogs and on our web site, Power Team electric power pump assemblies meet the design, assembly and test requirements of NEMA 12, a National Electrical Manufacturers' Association standard relating to electrical components used to resist moisture and dust. Note: If NEMA certification is required, it must be requested at the time a Power Team brand pump is ordered.

Product Design Criteria

All Power Team hydraulic components are designed and/or tested to be safe for use at maximum operating pressures of 10,000 psi unless otherwise specifically noted in our literature and catalogs and on our web site.

Quality Assurance

All of Power Team hydraulic cylinders are subjected to quality checks during production. All steel bar is certified and has material traceability to the mill. Before leaving the factory, all cylinders are pressure tested to 12,500 psi, except the RT series, which are tested to 10,000 psi to insure on-the-job reliability.



“Power Team” is a registered trademark of the SPX FLOW Hydraulic Technologies division of SPX FLOW Inc. (“SPX FLOW”). All Power Team products and parts, with the exceptions noted below, are warranted against defects in materials and workmanship for the life of the product or part. (The life of the product or part is defined as that point in time when it no longer safely or properly functions due to normal wear). Inflatable jacks, chains, batteries, electric motors, gas engines, knives and cutter blades which are sold with Power Team products are not covered by this warranty and instead are warranted as follows:

- Inflatable jacks and electronics are warranted against defects in materials and workmanship for a period of one year from date of purchase.
- Consumable parts or accessories, including without limitation, chains, batteries, knives and cutter blades are warranted against defects in materials and workmanship for a period of one year from date of purchase.
- All electric motors and gas engines are separately warranted by their respective manufacturer under the terms and conditions stated in their separate warranty.

The foregoing warranties do not cover ordinary wear and tear or any product or part that has been worn out, abused, heated, ground or otherwise altered, used for a purpose other than that for which it was intended or used in a manner inconsistent with any instructions regarding its use.

To qualify for warranty consideration, return the Power Team product, freight prepaid, to a Power Team authorized repair center or to the SPX FLOW factory. If any product or part manufactured by SPX FLOW found to be defective by SPX FLOW, in its sole judgment, SPX FLOW will, at its option, either repair or replace such defective product or part and return it via best ground transportation, freight prepaid. THIS REMEDY SHALL BE THE EXCLUSIVE REMEDY AVAILABLE FOR ANY DEFECTS IN THE PRODUCTS OR PARTS MANUFACTURED AND SOLD BY SPX FLOW OR FOR DAMAGES RESULTING FROM ANY OTHER CAUSE WHATSOEVER, INCLUDING WITHOUT LIMITATION, SPX FLOW'S NEGLIGENCE. SPX FLOW SHALL NOT, IN ANY EVENT, BE LIABLE TO ANY BUYER FOR CONSEQUENTIAL OR INCIDENTAL DAMAGES OF ANY KIND, WHETHER FOR DEFECTIVE OR NON-CONFORMING GOODS, NEGLIGENCE, ON THE BASIS OF STRICT LIABILITY OR FOR ANY OTHER REASON.

SPX FLOW's PowerThon™ Warranty is expressly limited to persons who purchase Power Team products or parts for the resale or for use in the ordinary course of the buyer's business.

THIS WARRANTY IS EXCLUSIVE, AND SPX FLOW MAKES NO OTHER WARRANTY OF ANY KIND WHATSOEVER, EXPRESSED OR IMPLIED, WITH RESPECT TO THE PRODUCTS MANUFACTURED AND SOLD BY IT, WHETHER AS TO MERCHANT-ABILITY, FITNESS FOR A PARTICULAR PURPOSE, OR ANY OTHER MATTER. No agent, employee, or representative of SPX FLOW has any authority to bind SPX FLOW to any affirmation, representation, or warranty concerning Power Team products or parts, except as stated herein.

The purpose of this exclusive remedy shall be to provide the buyer with repair or replacement of products or parts manufactured by SPX FLOW found to be defective in materials or workmanship or negligently manufactured. This exclusive remedy shall not be deemed to have failed of its essential purpose so long as SPX FLOW is willing and able to replace said defective products or parts in the prescribed manner.

Any inconsistent terms contained in SPX FLOW's Standard Terms and Conditions, or other SPX FLOW terms or warranty documents shall not be interpreted to modify or limit this PowerThon™ Warranty. For the avoidance of doubt, this PowerThon™ Warranty is applicable only to Power Team products and does not apply to any other SPX FLOW products.



Wear appropriate Personal Protective Equipment (PPE).



Read all instructions.



Do not exceed the rated load of any pump, tool or component.



Inspect all components before use. Do not use damaged or worn components. Return to an Authorized Repair Center for repair or replacement.



Never alter internal relief valves.

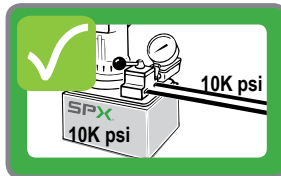
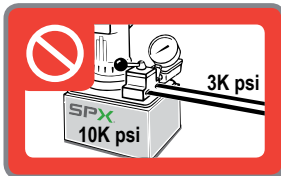

Recognize system pressures. Do not use a 10,000 PSI pump on a system with 3,000 PSI components (hoses, fittings, valves, tools, etc.).

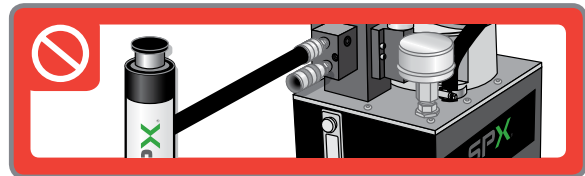

Do not use pumps designed for torque wrenches or tensioners for lifting.



Do not overfill pump reservoirs.



Use only high quality oil, like SPX Power Team hydraulic oil. Using the wrong fluid can lead to equipment damage and premature failure.

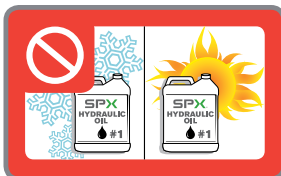

Do not use the same oil in all equipment and in all environments.

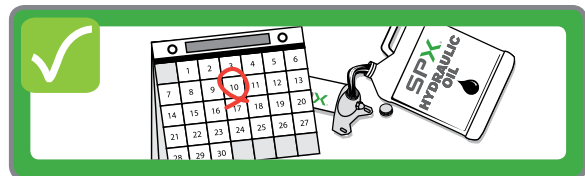

Change oil and/or filters at appropriate intervals.

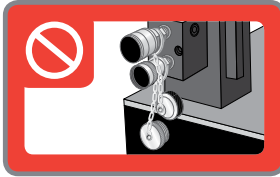

Do not operate a pump with couplers exposed or uncapped.

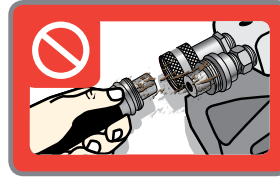
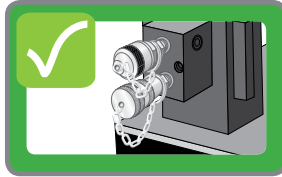

Clean both ends of the couplers before assembly.

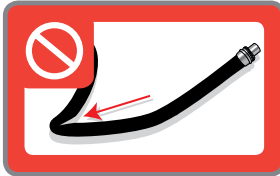

Do not kink hydraulic hoses.



Replace damaged hoses immediately.



Keep equipment away from excessive temperatures. Do not weld next to unprotected equipment.



Keep couplers capped when not in use.



Do not drive over hoses or drop objects onto them.

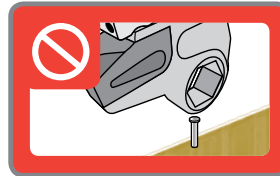

Only use tools for their intended purpose.

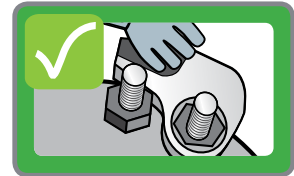

Keep hands clear of pinch points.

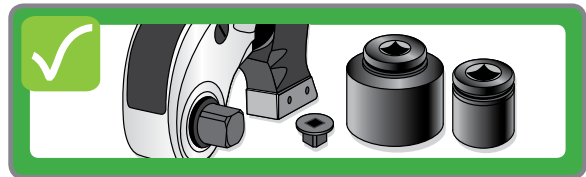
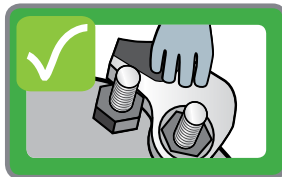

Only use high quality impact sockets and reducers with an appropriate load rating and safety factor.

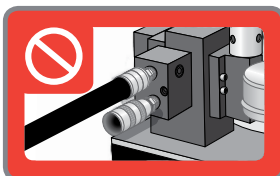

Always connect both torque wrench hoses to the pump. Do not operate with only one hose attached.

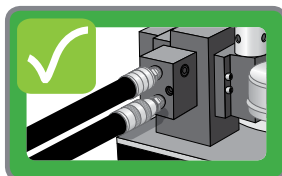

Use only the proper size sockets and links.





Application / Industry Highlight

Cement Plant, Manufacturing

Situation:

Customer asked for 100 Ton Heavy-Duty bearing puller, working with 50Hz power source with a global company. The application required removing bearings and gears in maintenance of shafts and rolling parts.

Solution:

Supplied 100T Puller # PTPH-100T-50-220

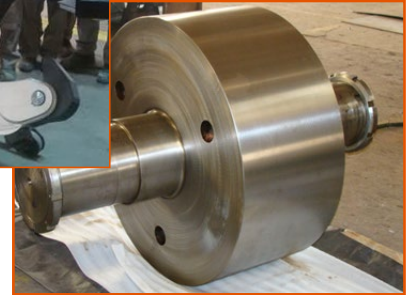

Application / Industry Highlight

Rail car Maintenance, Rail

Situation:

Customer needing a more reliable way to lift empty rail cars to install wheels. The cars are empty, but require fast speed for lifting. The standard RJ100T37E was slower than customer desired.

Solution:

RJ100T37E modified with a PE1204FR pump

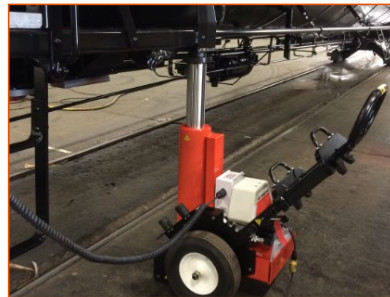

Application / Industry Highlight

Shipbuilding / Repair, Transportation

Situation:

Customer manufactures propeller shafts for large military vessels (Air Craft Carriers, Destroyers, etc). Having trouble with concentricity of dissimilar metals pulling apart during welding process, they needed something to keep them clamped.

Solution:

8-PH82K pullers





Application / Industry Highlight

Forklift Maintenance, Manufacturing

Situation:

Maintenance Technicians were getting injured lifting and positioning heavy floor jacks for routine maintenance on forklift machinery.

Solution:

Supplied IJ3615 Inflatable Jack, 350090 Pendent, (2) 350208 30' Hose



Application / Industry Highlight

Power Plant, Energy

Situation:

The incinerated coal is mixed with water and transported through several pipelines to the repository by very powerful pumps. These pipelines have flanges of various sizes. These flanges must be opened in certain periods and the seals must be changed.

Solution:

Hydraulic Torque Wrench set (TWHC1, TWHC3, PE45)



Application / Industry Highlight

Copper Mine, Mining

Situation:

Customer needed to lift this 680 Ton structure in a synchronized manner to replace the six-ton slewing bearing for this ship loader.

Solution:

Supplied one Motion Control System and 3 - 280 Ton Lock Nut Cylinders

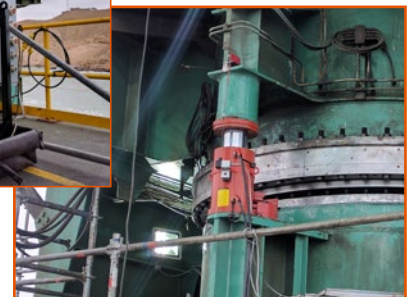



Countless applications are possible with Power Team hydraulic components. From pressing, lifting, and jacking applications to production or maintenance setups. The diagrams are typical electric/hydraulic units. Electric, air or gas-driven pumps are available.

Single-acting cylinder or cylinders in the circuit, controlled by a pump-mounted valve.

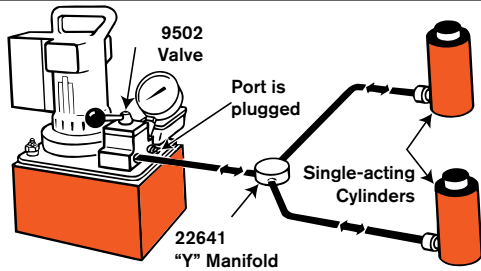

Double-acting cylinder or cylinders in the circuit, controlled by a pump-mounted valve.

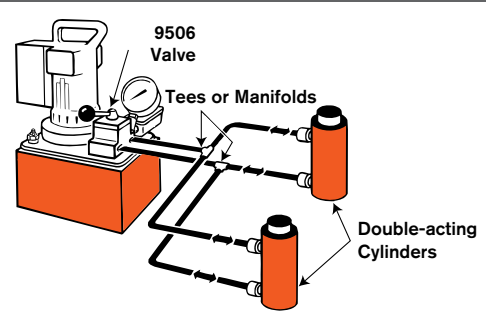

Single-acting cylinder controlled by a remote-mounted valve.

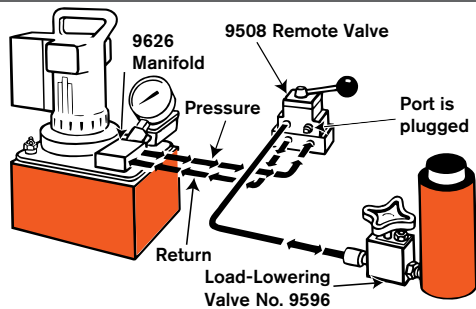

Double-acting cylinders controlled by a remote-mounted valve.

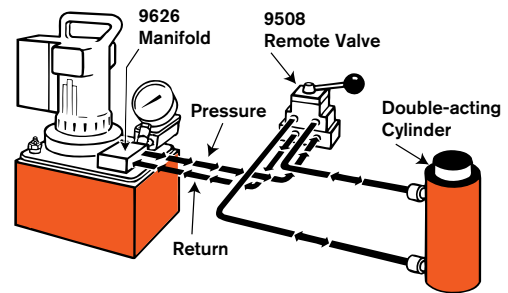

Single-acting cylinders with a sequence valve which controls the primary and secondary cylinder circuits.

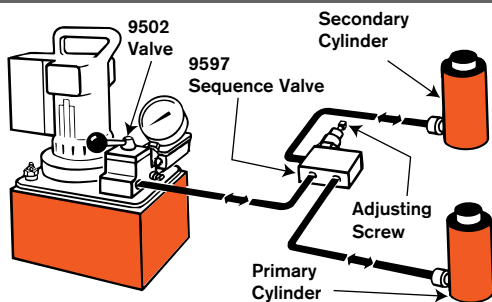

Double-acting cylinder with a sequence valve which controls the primary and secondary cylinder circuits.

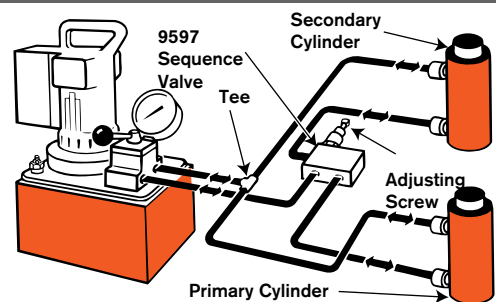



Hydraulic Circuit Components

- 1 **Cylinder** – applies hydraulic force.
- 2 **Pump** – a device for converting mechanical energy to fluid energy.
- 3 **Directional valve** – controls the direction of hydraulic fluid in the system.
- 4 **Gauge** – measures pressure (PSI - Pounds per Square Inch) and/or force.
- 5 **Hose** – transports hydraulic fluid.
- 6 **Manifold** – allows distribution of hydraulic fluid from one source to several cylinders. (9617)
- 7 **Swivel Connector** – allows proper alignment of valves and/or gauges. Used when units being connected cannot be rotated. (9675)
- 8 **Quick Coupling** – “hose half” and “cylinder half” couplings are used for quick-connection and fluid flow check when separated. (9797 and 9798)
- 9 **Shut-Off Valve** – regulates the flow of hydraulic fluid to or from cylinders. (9642 or 9644)
- 10 **Load-Lowering Valve** – allows metered lowering of cylinder and provides safety when prolonged load holding is required. (9596)
- 11 **T-Gauge Adapter** – allows for installation of pressure/tonnage gauge anywhere in the hydraulic system. (9670)
- 12 **Pipe Plug** – for blocking unused ports within the system. (9687)

Basic single-acting system with a hand pump, gauge, hose, multiple shut-off valves, load-lowering valves and multiple cylinders.

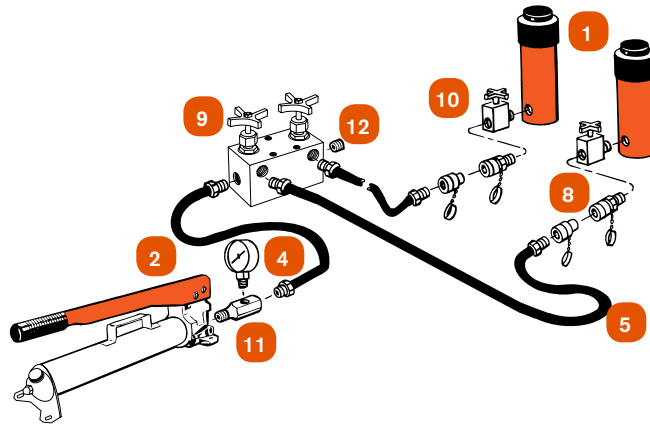

Basic double-acting system with an electric/hydraulic pump, shut-off valves, load-lowering valves and multiple double-acting cylinders.

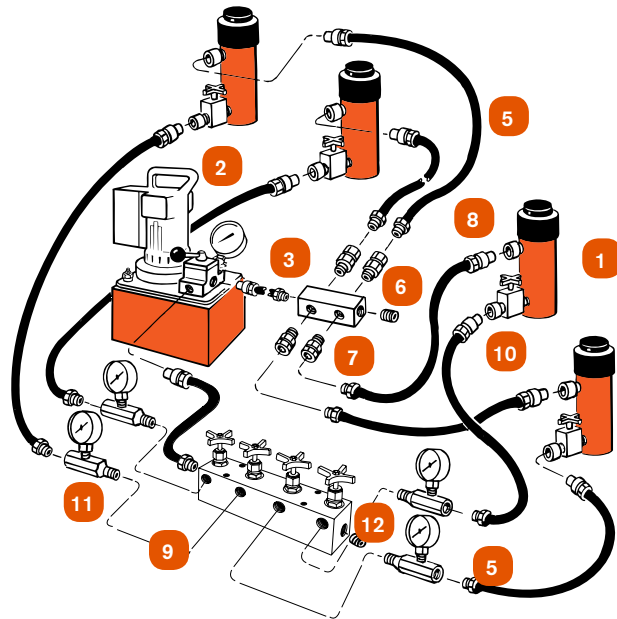



FRACTION	DECIMALS	MILLIMETERS	FRACTION	DECIMALS	MILLIMETERS
1/64	.015625	0.397	33/64	.515625	13.097
1/32	.03125	0.794	17/32	.53125	13.494
3/64	.046875	1.191	35/64	.546875	13.891
1/16	.0625	1.588	9/16	.5625	14.288
5/64	.078125	1.984	37/64	.578125	14.684
3/32	.09375	2.381	19/32	.59375	15.081
7/64	.109375	2.778	39/64	.609375	15.478
1/8	.1250	3.175	5/8	.6250	15.875
9/64	.140625	3.572	41/64	.640625	16.272
5/32	.15625	3.969	21/32	.65625	16.669
11/64	.171875	4.366	43/64	.671875	17.066
3/16	.1875	4.763	11/16	.6875	17.463
13/64	.203125	5.159	45/64	.703125	17.859
7/32	.21875	5.556	23/32	.71875	18.256
15/64	.234375	5.953	47/64	.734375	18.653
1/4	.2500	6.350	3/4	.7500	19.050
17/64	.265625	6.747	49/64	.765625	19.447
9/32	.28125	7.144	25/32	.78125	19.844
19/64	.296875	7.541	51/64	.796875	20.241
5/16	.3125	7.938	13/16	.8125	20.638
21/64	.328125	8.334	53/64	.828125	21.034
11/32	.34375	8.731	27/32	.84375	21.431
23/64	.359375	9.128	55/64	.859375	21.828
3/8	.3750	9.525	7/8	.8750	22.225
25/64	.390625	9.922	57/64	.890625	22.622
13/32	.40625	10.319	29/32	.90625	23.019
27/64	.421875	10.716	59/64	.921875	23.416
7/16	.4375	11.113	15/16	.9375	23.813
29/64	.453125	11.509	61/64	.953125	24.209
15/32	.46875	11.906	31/32	.96875	24.606
31/64	.484375	12.303	63/64	.984375	25.003
1/2	.5000	12.700	1	1.000	25.400

NOTE:

1 MM = .03937"

.001" = .0254 MM



	MULTIPLY SI* UNIT	BY CONVERSION FACTOR	TO GET OR MULTIPLY NON-SI UNIT	BY CONVERSION FACTOR	TO GET SI* UNIT
LENGTH	Millimeter (mm)	X 0.03937	= inch	X 25.4	= mm (1 inch = 25.4 mm exactly)
	Centimeter (cm) 10 mm	X 0.3937	= inch	X 2.54	= cm
	Meter (m) 1000 mm	X 3.28	= foot	X 0.305	= m
	meter (m)	X 1.09	= yard	X 0.914	= m
	kilometer (km) 1000 m	X 0.62	= mile	X 1.61	= km
AREA	millimeter ² (mm ²)	X 0.00155	= inch ²	X 645	= mm ²
	centimeter ² (cm ²)	X 0.155	= inch ²	X 6.45	= cm ²
	meter ² (m ²)	X 10.8	= foot ²	X 0.0929	= m ²
	meter ² (m ²)	X 1.2	= yard ²	X 0.836	= m ²
	hectare (ha) 10,000 m ²	X 2.47	= acre	X 0.405	= ha
	kilometer ² (km ²)	X 0.39	= mile ²	X 2.59	= km ²
VOLUME	centimeter ³ (cm ³)	X 0.061	= inch ³	X 16.4	= cm ³
	liter (L)	X 61	= inch ³	X 0.016	= L
	milliliter (mL)	X 0.034	= oz-liq	X 29.6	= mL (1 mL = 1 cm ³)
	liter (L) 1000 mL	X 1.06	= quart	X 0.946	= L
	liter (L)	X 0.26	= Gallon	X 3.79	= L
	meter ³ (m ³) 1000 L	X 1.3	= yard ³	X 0.76	= m ³
MASS	Gram (g)	X 0.035	= ounce	X 28.3	= g
	kilogram (kg) 1000 g	X 2.2	= pound	X 0.454	= kg
	metric ton (t) 1000 kg	X 1.1	= ton (short)	X 0.907	= t
FORCE	Newton (N)	X 0.225	= pound	X 4.45	= N
	kilo-newton (kN)	X 225	= pound	X 0.00445	= kN
	newton meter (Nm)	X 8.9	= lb. in.	X 0.113	= Nm
	newton meter (Nm)	X 0.74	= lb. ft.	X 1.36	= Nm
PRESSURE	kilo-pascal (kPa)	X 4.0	= in. H ₂ O	X 0.249	= kPa
	kilo-pascal (kPa)	X 0.30	= in. Hg	X 3.38	= kPa
	kilo-pascal (kPa)	X 0.145	= psi	X 6.89	= kPa
	mega-pascal (MPa)	X 145	= psi	X 0.00689	= MPa
	bar	X 14.5	= psi	X 0.0680	= bar
POWER	kilowatt (kw)	X 1.34	= hp	X 0.746	= kw
	kilowatt (kw)	X 0.948	= Btu/s	X 1.055	= kw
	watt (w)	X 0.74	= ft. lb/s	X 1.36	= w
FLOW	cu cm/min	X 0.061	= cu in/min	X 16.4	= cu cm/min
	liters/min	X 0.2642	= GPM	X 3.785	= liters/min

* SYSTEM INTERNATIONAL (MODERN METRIC SYSTEM)



Selecting the appropriate equipment for your application can be accomplished by following these three steps.

1) Understanding the “Pain Points”



2) Connect “Application” to a Function



3) Select the correct tool for the function required



STEP 1: Determine the type of lift or tool required for your application:

- Single or multiple-point lift?
- Balanced or unbalanced load?
- Guided or unguided load?
- Pulling, pressing, punching, spreading or torquing?

STEP 2: Choose the right cylinder or tool for your specific application:

- Determine the force required. (Power Team recommends using 80% of the rated capacity and stroke to maximize product performance and safety.)
- Determine the total amount of oil required for each cylinder(s) and/or tool(s).
- Determine the closed height, stroke requirement and diameter footprint allowable.
- Push and/or pull requirement. For cylinders, single-acting, load return, spring return or double-acting hydraulically driven both ways.

STEP 3: Choose the right pump source for your application based on your cylinder /tools and oil / speed requirements:

- What is the maximum system operating pressure requirement?
- What is the volume of oil required? Add all of the cylinder(s) and/or tool(s) cubic volume requirements and add 1 cubic inch per 1.66 foot of hose.
- What is the preferred source of power? (hand, air, electric, or gas). If hand pump is selected, choose between single or two-speed.
- Do you need this to be portable? (consider weight and size).

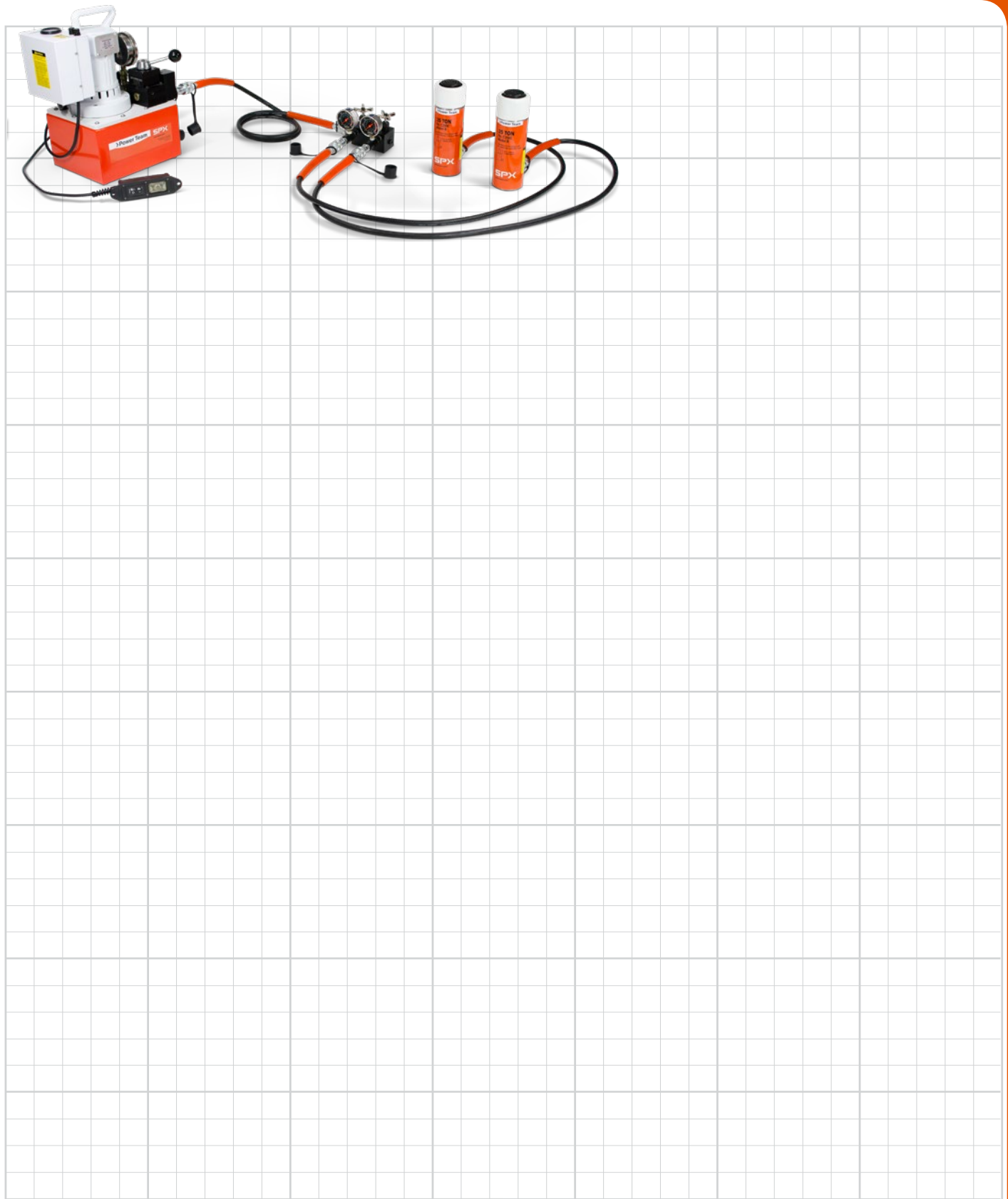



Cylinder Order Number	Seal Kit*	Viton™ Seal Kit
C51C	300404	300210
C53C	300404	300210
C55C	300404	300210
C57C	300404	300210
C59C	300404	300210
C101C	300116	300211
C102C	300116	300211
C104C	300116	300211
C106C	300116	300211
C108C	300116	300211
C1010C	300116	300211
C1012C	300116	300211
C1014C	300116	300211
C1016C	300116	300211
C151C	300453	300471
C152C	300453	300471
C154C	300453	300471
C156C	300453	300471
C158C	300453	300471
C1510C	300453	300471
C1512C	300453	300471
C1514C	300453	300471
C1516C	300453	300471
C251C	300147	300213
C252C	300147	300213
C254C	300147	300213
C256C	300147	300213
C258C	300147	300213
C2510C	300147	300213
C2512C	300147	300213
C2514C	300147	300213
C552C	300114	300215
C554C	300114	300215
C556C	300114	300215
C5510C	300114	300215
C5513C	300114	300215
C756C	300647	300846
C7513C	300647	300846
C1002C	300112	300216
C1006C	300112	300216
C10010C	300112	300216
C55CBT	300404	300210
C106CBT	300116	300211
C256CBT	300147	300213

Cylinder Order Number	Seal Kit*	Viton™ Seal Kit
R1502C	300676	—
R1506C	300676	—
R15010C	300676	—
R2002C	300677	—
R2006C	300677	—
R20010C	300677	—
R2802C	300678	—
R2806C	300678	—
R28010C	300678	—
R3552C	300679	—
R3556C	300679	—
R35510C	300679	—
R4302C	300680	—
R4306C	300680	—
R43010C	300680	—
R5652C	300681	—
R5656C	300681	—
R56510C	300681	—
R1002D	300928	—
R1006D	300928	—
R10010D	300928	—
R1502D	300929	—
R1506D	300929	—
R15010D	300929	—
R2002D	300930	—
R2006D	300930	—
R20010D	300930	—
R2802D	300931	—
R2806D	300931	—
R28010D	300931	—
R3552D	300932	—
R3556D	300932	—
R35510D	300932	—
R4302D	301047	—
R4306D	301047	—
R43010D	301047	—
R5652D	300934	—
R5656D	300934	—
R56510D	300934	—
R552L	300674	—
R556L	300674	—
R5510L	300674	—
R1002L	300675	—
R1006L	300675	—

Cylinder Order Number	Seal Kit*	Viton™ Seal Kit
R10010L	300675	—
R1502L	300676	—
R1506L	300676	—
R15010L	300676	—
R2002L	300677	—
R2006L	300677	—
R2008L	300677	—
R20010L	300677	—
R2802L	300678	—
R2806L	300678	—
R28010L	300678	—
R3552L	300679	—
R3556L	300679	—
R35510L	300679	—
R4302L	300680	—
R4306L	300680	—
R43010L	300680	—
R5652L	300681	—
R5656L	300681	—
R56510L	300681	—
RA202	300631	—
RA204	300631	—
RA206	300631	—
RA302	300632	—
RA304	300632	—
RA306	300632	—
RA552	300391	—
RA554	300391	—
RA556	300391	—
RA5510	300391	—
RA1002	300444	—
RA1006	300444	—
RA10010	300444	—
RA556L	300395	—
RA1006L	300396	—
RD106	300017	—
RD1010	300017	—
RD256	300018	—
RD2514	300018	—
RD556	300005	—
RD5513	300005	—
RD5518	300005	—
RD8013	300410	—
RD1006	300120	—

Cylinder Order Number	Seal Kit*	Viton™ Seal Kit
RD10013	300120	—
RD10020	300120	—
RD1506	300007	—
RD15013	300007	—
RD15018	300007	—
RD2006	300008	—
RD20013	300008	—
RD3006	300466	—
RD30013	300466	—
RD4006	300467	—
RD40013	300467	—
RD5006	300468	—
RD50013	300468	—
RDG552	3000906	—
RDG554	3000906	—
RDG556	3000906	—
RDG558	3000906	—
RDG5510	3000906	—
RDG5512	3000906	—
RDG5513	3000906	—
RDG5514	3000906	—
RDG752	3000908	—
RDG754	3000908	—
RDG756	3000908	—
RDG758	3000908	—
RDG7510	3000908	—
RDG7512	3000908	—
RDG7513	3000908	—
RDG7514	3000908	—
RDG1002	3000876	—
RDG1004	3000876	—
RDG1006	3000876	—
RDG1008	3000876	—
RDG10010	3000876	—
RDG10012	3000876	—
RDG10013	3000876	—
RDG10014	3000876	—
RDG1502	3000881	—
RDG1504	3000881	—
RDG1506	3000881	—
RDG1508	3000881	—
RDG15010	3000881	—
RDG15012	3000881	—
RDG15013	3000881	—

Viton™ is an trademarks or registered trademarks of The Chemours Company

* Nitrile seals comes standard on all cylinders.



Cylinder Order Number	Seal Kit*	Viton™ Seal Kit
RDG15014	3000881	—
RDG2002	3000891	—
RDG2004	3000891	—
RDG2006	3000891	—
RDG2008	3000891	—
RDG20010	3000891	—
RDG20012	3000891	—
RDG20013	3000891	—
RDG20014	3000891	—
RDG2502	3000911	—
RDG2504	3000911	—
RDG2506	3000911	—
RDG2508	3000911	—
RDG25010	3000911	—
RDG25012	3000911	—
RDG25013	3000911	—
RDG25014	3000911	—
RDG3002	3000920	—
RDG3004	3000920	—
RDG3006	3000920	—
RDG3008	3000920	—
RDG30010	3000920	—
RDG30012	3000920	—
RDG30013	3000920	—
RDG30014	3000920	—
RDG4002	3000903	—
RDG4004	3000903	—
RDG4006	3000903	—
RDG4008	3000903	—
RDG40010	3000903	—
RDG40012	3000903	—
RDG40013	3000903	—
RDG40014	3000903	—
RDG5002	3000921	—
RDG5004	3000921	—
RDG5006	3000921	—
RDG5008	3000921	—
RDG50010	3000921	—
RDG50012	3000921	—
RDG50013	3000921	—
RDG50014	3000921	—
RDG6002	3000901	—
RDG6004	3000901	—
RDG6006	3000901	—

Cylinder Order Number	Seal Kit*	Viton™ Seal Kit
RDG6008	3000901	—
RDG60010	3000901	—
RDG60012	3000901	—
RDG60013	3000901	—
RDG60014	3000901	—
RGG556	3001016	—
RGG558	3001016	—
RGG5510	3001016	—
RGG5512	3001016	—
RGG5513	3001016	—
RGG5514	3001016	—
RGG752	3001049	—
RGG754	3001049	—
RGG756	3001049	—
RGG758	3001049	—
RGG7510	3001049	—
RGG7512	3001049	—
RGG7513	3001049	—
RGG7514	3001049	—
RGG1002	3001018	—
RGG1004	3001018	—
RGG1006	3001018	—
RGG1008	3001018	—
RGG10010	3001018	—
RGG10012	3001018	—
RGG10013	3001018	—
RGG10014	3001018	—
RGG1502	3001019	—
RGG1504	3001019	—
RGG1506	3001019	—
RGG1508	3001019	—
RGG15010	3001019	—
RGG15012	3001019	—
RGG15013	3001019	—
RGG15014	3001019	—
RGG2002	3001050	—
RGG2004	3001050	—
RGG2006	3001050	—
RGG2008	3001050	—
RGG20010	3001050	—
RDG20012	3001050	—
RGG20013	3001050	—
RGG20014	3001050	—
RGG2502	3001051	—

Cylinder Order Number	Seal Kit*	Viton™ Seal Kit
RGG2504	3001051	—
RGG2506	3001051	—
RGG2508	3001051	—
RGG25010	3001051	—
RGG25012	3001051	—
RGG25013	3001051	—
RGG25014	3001051	—
RGG3002	3001022	—
RGG3004	3001022	—
RGG3006	3001022	—
RGG3008	3001022	—
RGG30010	3001022	—
RGG30012	3001022	—
RGG30013	3001022	—
RGG30014	3001022	—
RGG4002	3001023	—
RGG4004	3001023	—
RGG4006	3001023	—
RGG4008	3001023	—
RGG40010	3001023	—
RGG40012	3001023	—
RGG40013	3001023	—
RGG40014	3001023	—
RGG5002	3001024	—
RGG5004	3001024	—
RGG5006	3001024	—
RGG5008	3001024	—
RGG50010	3001024	—
RGG50012	3001024	—
RGG50013	3001024	—
RGG50014	3001024	—
RGG6002	3001025	—
RGG6004	3001025	—
RGG6006	3001025	—
RGG6008	3001025	—
RGG60010	3001025	—
RGG60012	3001025	—
RGG60013	3001025	—
RGG60014	3001025	—
RH102	300071	300221
RH108	300071	300221
RH120	300657	—
RH121	300576	—
RH121T	300576	—

Cylinder Order Number	Seal Kit*	Viton™ Seal Kit
RH123	300576	—
RH202	300615	—
RH203	300069	300222
RH206	300615	—
RH302	300037	300223
RHA306	300867	300868
RH306	300037	300223
RH503	300059	300225
RH603	300477	300476
RH606	300477	300476
RH1003	300485	300585
RH303	300077	300224
RH306D	300822	300224
RH3010	300625	—
RHA604D	300269	300226
RH605	300269	300226
RH6010	300626	—
RH1001	300927	—
RH1006	300295	300227
RH10010	300629	—
RH1505	300154	—
RH1508	300583	—
RH2008	300582	—
RLS50	300454	—
RLS100	300455	—
RLS200	300456	—
RLS300	300457	—
RLS500S	300458	—
RLS750S	300459	—
RLS1000S	300460	—
RLS1500S	300461	—
RP25	300628	—
RP55	300627	—
RSS101	300010	—
RSS202	300011	—
RSS302	300297	—
RSS502	300292	—
RSS1002	300293	—
RSS2503	—	—
RSS1002D	300578	—
RT172	300358	—
RT302	300359	—
RT503	300360	—
RT1004	300024	—

Viton™ is an trademarks or registered trademarks of The Chemours Company

* Nitrile seals comes standard on all cylinders.

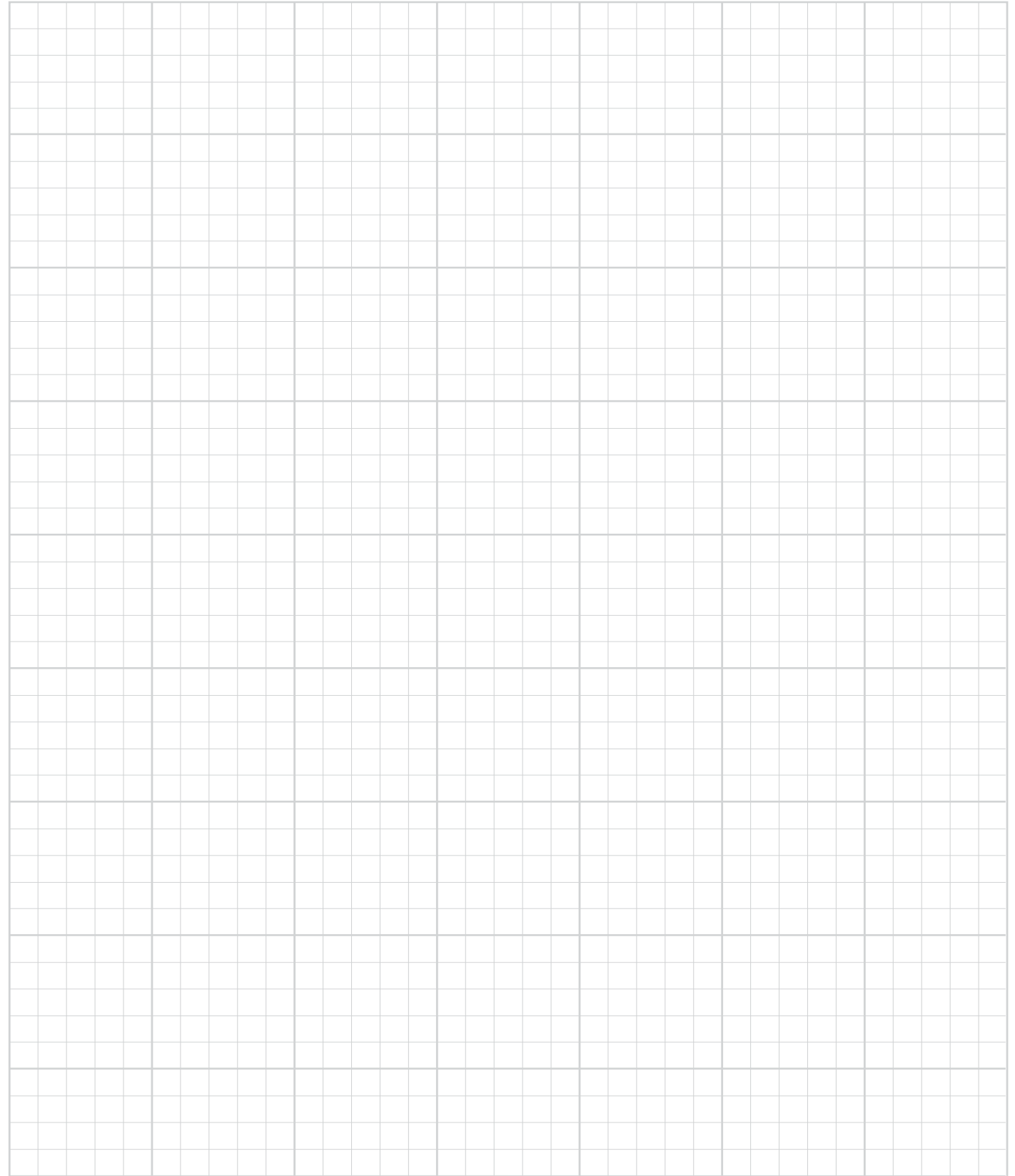

POWER TEAM TECHNICAL TRAINING ACADEMY

Maintaining and repairing mining equipment can be a cumbersome task, count on Power Team Tools and Equipment to get the job done safely and efficiently, keeping your downtime to a minimum.

Our tools are used in a variety of tasks to support virtually any MRO application. Look to Power Team for the expertise and technical support to perform a variety of functions to simply your task while enhancing your safety.

Our broad product portfolio of solutions will enable you to:



Power Team offers a range of classes to help you safely operate and maintain your tools.



On-site Safety Training

Workplace safety should be a high priority to assure high-pressure hydraulic tools are used in accordance with recommended safety procedures. Power Team Safety Training Seminars demonstrate the proper methods for operating high-pressure hydraulic tools to avoid equipment damage and lost time accidents. Safety seminars can be conducted at a customer facility, job site or at Power Team headquarters.

Factory Maintenance & Repair Training

Maintaining Power Team products in good operating condition enhances operating efficiency and extends service life. This seminar explains the proper methods for keeping Power Team products operating at peak levels of performance and reliability. Topics include understanding hydraulic circuits, product maintenance, troubleshooting, and field repairs. Three and five day seminars are structured to meet your product knowledge requirements.

Class schedules are posted on powerteam.com. Contact your district sales manager for more information.

> Power Team®

GLOBAL CUSTOMER SERVICE CENTERS

North America Headquarters

5885 11th Street
Rockford, IL 61109
USA

Customer Service/Order Entry

Tel: +1 800 541 1418
Fax: +1 800 288 7031

Send P.O.'s to: info@powerteam.com

Technical Services

Tel: +1 800 477 8326
Fax: +1 800 765 8326

European Headquarters

Albert Thijsstraat 12
6471 WX Eyselshoven
The Netherlands
Tel: +31 45 567 8877

infoeurope@powerteam.com

SEA Headquarters

20 Pioneer Crescent #06-01
West Park BizCentral
Singapore 628555
Tel: +65 6264 4366
Fax: +65 6265 9133

infoasia@powerteam.com

China Headquarters

7F Treasury Building
1568 Huashan Road
Shanghai, 200052 China
Tel: +86 21 2208 5888
Fax: +86 21 2208 5682

infochina@powerteam.com

Australia Headquarters

Level 2, Quad 2, 6 Parkview Dr. Sydney
Olympic Park,
NSW 2127 Australia
Tel: +61 3 9589 9222

Distributed by:

Visit us at powerteam.com to learn more.

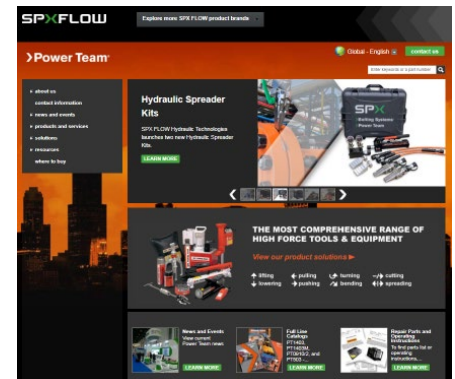

Power Team[®]

SPX FLOW, Inc. reserves the right to incorporate our latest design and material changes without notice or obligation.

Design features, materials of construction and dimensional data, as described in this bulletin, are provided for your information only and should not be relied upon unless confirmed in writing. Please contact your local sales representative for product availability in your region. For more information visit www.spxflow.com.

The green ">" and "X" are trademarks of SPX FLOW, Inc.

Bulletin: PT1807A Version: 10/2018

COPYRIGHT © 2018 SPX FLOW INC.